



AC30 series Variable Speed Drive

HA503711U003 Issue 4: Software Reference

aerospace
climate control
electromechanical
filtration
fluid & gas handling
hydraulics
pneumatics
process control
sealing & shielding



ENGINEERING YOUR SUCCESS.

**FAILURE OR IMPROPER SELECTION OR IMPROPER USE OF THE PRODUCTS DESCRIBED HEREIN OR RELATED ITEMS
CAN CAUSE DEATH, PERSONAL INJURY AND PROPERTY DAMAGE.**

This document and other information from Parker Hannifin Corporation, its subsidiaries and authorized distributors provide product or system options for further investigation by users having technical expertise.

The user, through its own analysis and testing, is solely responsible for making the final selection of the system and components and assuring that all performance, endurance, maintenance, safety and warning requirements of the application are met. The user must analyze all aspects of the application, follow applicable industry standards, and follow the information concerning the product in the current product catalogue and in any other materials provided from Parker Hannifin Corporation or its subsidiaries or authorized distributors.

To the extent that Parker Hannifin Corporation or its subsidiaries or authorized distributors provide component or system options based upon data or specifications provided by the user, the user is responsible for determining that such data and specifications are suitable and sufficient for all applications and reasonably foreseeable uses of the components or systems.

The above disclaimer is being specifically brought to the user's attention and is in addition to and not in substitution to the Exclusions and Limitations on Liability which are set out in the terms and conditions of sale.

AC30 Series Software Reference

HA503711U003 Issue 4

Compatible with Firmware versions X.19 onwards



2019 © Parker Hannifin Manufacturing Limited.

All rights strictly reserved. No part of this document may be stored in a retrieval system, or transmitted in any form or by any means to persons not employed by a Parker Hannifin Manufacturing Limited company without written permission from Parker Hannifin Manufacturing Ltd. Although every effort has been taken to ensure the accuracy of this document it may be necessary, without notice, to make amendments or correct omissions Parker Hannifin Manufacturing Limited cannot accept responsibility for damage, injury, or expenses resulting therefrom.

WARRANTY

The general terms and conditions of sale of goods and/or services of Parker Hannifin Europe Sàrl, Luxembourg, Switzerland Branch, Etoy, apply to this contract unless otherwise agreed. The terms and conditions are available on our website: www.parker.com/termsandconditons/switzerland

Parker Hannifin Manufacturing Limited reserved the right to change the content and product specification without notice.

Contents Page No.

Chapter 1: Safety	1-1
Requirements.....	1-1
Intended Users	1-1
Application Area.....	1-1
Personnel.....	1-2
Hazards	1-2
 Chapter 2: Introduction	 2-1
About this Manual	2-1
 Chapter 3: Product Overview.....	 3-1
Product Range	3-1
Power Stack Features	3-2
Functional Overview	3-3
AC30 Series Control Features.....	3-7
 Chapter 4: The Graphical Keypad	 4-1
Overview.....	4-2
Keypad.....	4-3
LED Status Indication	4-4
The Display.....	4-5
Top Line - Inverter Status Summary.....	4-5
Bottom Line – Soft Key Action Indication.....	4-6
The Menu System	4-7
Trips and other information displays	4-8
Setting the display language.....	4-8
Setup Wizard	4-9
Firmware Update	4-10

Contents Page No.

Chapter 5: Menu Organisation.....	5-1
Menu Map	5-1
Menu Map Summary	5-1
Menu Descriptions	5-2
Control Screen	5-2
Setup.....	5-2
Monitor.....	5-2
Favourites.....	5-2
Parameters	5-3
Parameter Map	5-3
 Chapter 6: Setup Wizard.....	 6-1
GKP Setup Wizard	6-1
Setup Wizard Stages	6-2
Application selection.....	6-3
Input and Output Option	6-4
Analog Input and Output.....	6-4
Motor Data	6-5
Fieldbus Options.....	6-6
Autotune Parameters.....	6-8
Finalising Setup	6-8
Set Up PMAC Motor Control - Sensorless	6-9
Set Up PMAC Motor Control – Encoder Feedback.....	6-10
Set Up PMAC Motor Control – Pos Alignment after Power-up ..	6-12
Parker Drive Quicktool (PDQ) PC Software	6-13
Installation	6-13
Starting the Wizard	6-15
Task selection	6-16
Application Macro.....	6-19
Drive Hardware.....	6-20
Motor Setup	6-21
Motor Control Strategy	6-22
I/O	6-23
Communications	6-24
Monitor the Drive	6-26

2 Contents

<i>Contents</i>	<i>Page No.</i>
Chapter 7: Trips & Fault Finding	7-1
What Happens when a Trip Occurs	7-1
Keypad Indications	7-1
Resetting a Trip Condition	7-1
Using the Keypad to Manage Trips	7-2
Trip Messages	7-2
Hexadecimal Representation of Trips	7-8
Runtime Alerts	7-9
Autotune Alerts	7-11
Other Alerts	7-12
Fault Finding	7-14
Black Box Feature	7-15
Black Box File Format.....	7-15
Diagnostic LEDs	7-17
Chapter 8: Ethernet	8-1
Connecting to the Inverter	8-1
Recommended Cable.....	8-1
AC30V.....	8-1
AC30P or AC30D	8-2
Ethernet Setup	8-3
Configuration.....	8-3
Advanced Configuration.....	8-3
Typical Wiring Configurations	8-6
Ethernet Parameter Summary	8-9
Troubleshooting the Ethernet	8-12
Web (HTTP) Server	8-15
Web Pages	8-15
Web Server Parameter Summary.....	8-17
Troubleshooting the Web Server.....	8-18
Simple Network Time Protocol (SNTP) Client	8-19
SNTP Client Parameter Summary.....	8-19

<i>Contents</i>	<i>Page No.</i>
SNTP Client Operation	8-19
SNTP Relationship with time zone and Daylight Saving	8-19
Simple Network Time Protocol (SNTP) Server	8-20
SNTP Server Parameter Summary	8-20
SNTP Server Operation	8-20
Precision Time Protocol (PTP)	8-21
Configuration	8-21
Advanced Configuration	8-21
PTP Parameter Summary	8-24
Peer to Peer	8-28
Configuration	8-28
Peer to Peer Parameter Summary	8-30
Chapter 2: Fire Mode	2-1
Configuration	2-2
Functional Description	2-3
Trips and Auto Restart	2-4
Appendix A: Fieldbuses	A-1
Modbus TCP	A-1
Introduction	A-1
Fixed Parameter Mapping	A-2
User-Defined Parameter Mapping	A-5
Password Protection	A-6
Supported Modbus Functions	A-7
Modbus Exception Codes	A-8
Process Active and Lost Communications Trip.....	A-8
Parameter Summary.....	A-9
EtherNet/IP Adapter	A-11
Introduction	A-11
Inverter Configuration	A-12
Example PLC Configurations	A-15
Explicit Access of Parameters.....	A-24
Lost Communications Trip	A-24
Troubleshooting and Tips.....	A-25

Contents	Page No.
CIP Objects	A-26
Parameter Summary	A-30
PROFINET IO Device	A-32
Introduction	A-32
Inverter Configuration.....	A-33
Example PLC Configurations	A-37
Acyclic Access of Inverter Parameters	A-48
Lost Communications Trip.....	A-51
Troubleshooting and Tips	A-51
Parameter Summary	A-52
Chapter 2: Sequencing Logic	2-1
Drive State Machine	2-1
DS402	2-1
Sequencing State	2-1
Sequencing Diagram.....	2-2
State Transitions	2-3
Control Word	2-5
Status Word	2-6
Appendix C: Parameter Reference	C-1
Parameter Descriptions	C-1
Active Front End (AFE).....	C-2
App Info.....	C-13
Auto Restart.....	C-15
Autotune	C-20
BACnet IP Option	C-24
BACnet MSTP Option.....	C-25
Black Box.....	C-26
Braking.....	C-27
CANopen Option	C-29
Clone	C-30
Communications Options.....	C-34
Configure, (Phase Control).....	C-35
Control Mode	C-38
ControlNet Option	C-42
Current Limit.....	C-43
Current Loop	C-44

Contents	Page No.
Current Sensor Trip	C-45
Data Logger.....	C-46
DC Link Volts Limit.....	C-51
Device Commands.....	C-53
Device State	C-54
DeviceNet Option	C-56
Drive info	C-57
Encoder	C-62
Energy Meter	C-64
EtherCAT Option.....	C-66
Ethernet	C-67
EtherNet IP Adapter	C-67
EtherNet IP Option	C-67
Fan Control.....	C-68
Feedbacks	C-69
Fieldbus Mapping	C-73
Filter On Torque Dmd.....	C-74
Flash File System.....	C-77
Fluxing VHz	C-78
Flycatching.....	C-83
General Purpose IO	C-85
Graphical Keypad	C-87
Induction Motor Data.....	C-90
Inj Braking	C-92
IO Configure	C-94
IO Option Common.....	C-100
IO Values	C-102
Keypad Override	C-105
Local Control.....	C-106
Maintenance Monitor	C-107
Minimum Speed	C-109
Modbus	C-110
Modbus RTU Option	C-111
Modbus TCP Option	C-112
Motor Load	C-113
Motor Nameplate.....	C-116
Motor Sequencer.....	C-118
MRAS	C-119
Parameter Backup	C-121
Pattern Generator	C-122
Peer to Peer.....	C-124

4 Contents

<i>Contents</i>	<i>Page No.</i>
PID	C-125
PMAC Flycatching	C-127
PMAC Motor Advanced	C-129
PMAC Motor Data	C-130
PMAC SVC	C-134
Pos Fbk Alignment	C-142
Power Loss Ride Thru	C-150
Precision Time Protocol (PTP)	C-153
Preset Speeds	C-154
Profibus DP-V1 Option	C-156
PROFINET IO Option	C-157
Raise Lower	C-158
Ramp	C-160
Real Time Clock	C-166
Resolver	C-167
Runtime Statistics	C-172
SB Digital IO	C-174
SB Encoder	C-177
SB Encoder Slot 1	C-180
SB Encoder Slot 2	C-182
SB Retransmit	C-183
Scale Setpoint	C-186
SD Card	C-187
Sequencing	C-188
Setup Wizard	C-192
Skip Frequencies	C-194
Slew Rate	C-197
Slip Compensation	C-198
SNTP Client	C-199
SNTP Server	C-199
Soft Menus	C-200
Spd Direct Input	C-202
Spd Loop Diagnostics	C-203
Spd Loop Settings	C-204
Speed Error Trip	C-208
Speed Ref	C-209
Stabilisation	C-210
Stack Inv Time	C-211
Stall Trip	C-214
System Board Option	C-215
Thermistor	C-216

<i>Contents</i>	<i>Page No.</i>
Torque Limit	C-217
Tr Adaptation	C-220
Trips History	C-221
Trips Status	C-222
VDC Ripple	C-227
Voltage Control	C-228
Web Server	C-229
Parameter Tables	C-230
Parameters Defined in the Firmware	C-232
Parameters Defined in the Default Application	C-265
Table of Parameters in Alphabetical Order	C-266
Power Dependent Parameter Defaults	C-271

Appendix D: AC30 Series Product Codes D-1

Understanding the Product Code	D-1
AC30 Series Control Module	D-1
AC30 Series Power Stack	D-2
Configured AC30 Series Inverter	D-3
AC30 Series Regenerative Supply Unit	D-4

Appendix E: Library Function Blocks E-1

Introduction	E-1
Function Block List	E-2
Blocks in “AC30 Standard” library	E-2
Function Block Descriptions	E-3
Abnormal Load Detect	E-3
Application Alert	E-6
Application Trips	E-7
Application Trips Text	E-8
Brake Control	E-9
Data Logger Int	E-11
Data Logger Real	E-11
Filter & Filter 2	E-13
Fire Mode	E-14
Home	E-15

<i>Contents</i>	<i>Page No.</i>
KTY 84 130 Converter	E-16
Linear Fit.....	E-17
Linear Fit 2.....	E-18
Linear Ramp	E-20
Minimum Speed2.....	E-22
NTC Thermistor Converter	E-23
NTC Trip Levels.....	E-24
PID	E-25
Position	E-27
Presets2	E-28
PT1000 Converter.....	E-29
PT1000 Trip Levels.....	E-29
Queue Parameter Write.....	E-30
Queued Write Control	E-30
Raise Lower	E-32
Read Data From SD Card.....	E-33
Sequencing Logic2	E-34
Skip Frequencies	E-36
Speed Sensor Fault Ride Through.....	E-38
S Ramp.....	E-39
Time Of Day Select.....	E-41
Welcome Screen	E-43
Write Data to SD Card & Write Data to SD Card V2.....	E-44
Zero Speed.....	E-45

<i>Contents</i>	<i>Page No.</i>
-----------------------	-----------------

6 Contents

Contents *Page No.*

Contents *Page No.*

Chapter 1: Safety

Safety Information

IMPORTANT Please read these important Safety notes before installing and operating this equipment

CAUTION

CAUTION notes in the manual warn of danger to equipment.

WARNING

NOTES IN THE MANUAL WARN OF DANGER TO PERSONEL

Requirements

Intended Users

This manual is to be made available to all persons who are required to install, configure or service equipment described herein, or any other associated operation.

The information given is intended to highlight safety issues, and to enable the user to obtain maximum benefit from the equipment. Complete the following table for future reference detailing how the unit is to be installed and used.

INSTALLATION DETAILS			
Model Number <i>(see product label)</i>		Where installed <i>(for your own information)</i>	
Unit used as a: <i>(refer to Certification)</i>	<input type="checkbox"/> Component <input type="checkbox"/> Relevant Apparatus	Unit fitted:	<input type="checkbox"/> Cubicle mounted <input type="checkbox"/> Through Panel Mounted

Application Area

The equipment described is intended for industrial motor speed control utilising AC induction motors or AC permanent magnet synchronous machines.

1-2 Safety

Personnel

Installation, operation and maintenance of the equipment should be carried out by competent personnel. A competent person is someone who is technically qualified and familiar with all safety information and established safety practices; with the installation process, operation and maintenance of this equipment; and with all the hazards involved.



DANGER
Risk of electric shock



WARNING
Hot surfaces



Caution
Refer to documentation



Earth/Ground
Protective Conductor Terminal

Hazards

DANGER! - Ignoring the following may result in injury

1. This equipment can endanger life by exposure to rotating machinery and high voltages.
2. The equipment must be permanently earthed due to the high earth leakage current, and the inverter motor must be connected to an appropriate safety earth.
3. Ensure all incoming supplies are isolated before working on the equipment. Be aware that there may be more than one supply connection to the inverter.
4. There may still be dangerous voltages present at power terminals (motor output, supply input phases, DC bus and the brake, where fitted) when the motor is at standstill or is stopped.
5. For measurements use only a meter to IEC 61010 (CAT III or higher). Always begin using the highest range. CAT I and CAT II meters must not be used on this product.
6. Allow at least 5 minutes for the inverter's capacitors to discharge to safe voltage levels (<50V). Use the specified meter capable of measuring up to 1000V dc & ac rms to confirm that less than 50V is present between all power terminals and between power terminals and earth.
7. Unless otherwise stated, this product must NOT be dismantled. In the event of a fault the inverter must be returned. Refer to "Routine Maintenance and Repair".

WARNING! - Ignoring the following may result in injury or damage to equipment

SAFETY

Where there is conflict between EMC and Safety requirements, personnel safety shall always take precedence.

- Never perform high voltage resistance checks on the wiring without first disconnecting the inverter from the circuit being tested.
- Whilst ensuring ventilation is sufficient, provide guarding and /or additional safety systems to prevent injury or damage to equipment.
- When replacing an inverter in an application and before returning to use, it is essential that all user defined parameters for the product's operation are correctly installed.
- All control and signal terminals are SELV, i.e. protected by double insulation. Ensure all external wiring is rated for the highest system voltage.
- Thermal sensors contained within the motor must have at least basic insulation.
- All exposed metalwork in the Inverter is protected by basic insulation and bonded to a safety earth.
- RCDs are not recommended for use with this product but, where their use is mandatory, only Type B RCDs should be used.

EMC

- In a domestic environment this product may cause radio interference in which case supplementary mitigation measures may be required.
- This equipment contains electrostatic discharge (ESD) sensitive parts. Observe static control precautions when handling, installing and servicing this product.
- This is a product of the restricted sales distribution class according to IEC 61800-3. It is designated as "professional equipment" as defined in EN61000-3-2 for frames sizes D & E (7.5kW). Permission of the supply authority shall be obtained before connection to the public low voltage supply. Frame sizes E (11kW) to N harmonics conform to the limits of IEC61000-3-12:2011 (table 4).

WARNING! – Control Unit Removal / Fitting

Isolate supply before plugging or unplugging control unit to the power stack.

CAUTION!

APPLICATION RISK

- The specifications, processes and circuitry described herein are for guidance only and may need to be adapted to the user's specific application. We can not guarantee the suitability of the equipment described in this Manual for individual applications.

RISK ASSESSMENT

Under fault conditions, power loss or unintended operating conditions, the inverter may not operate as intended. In particular:

- Stored energy might not discharge to safe levels as quickly as suggested, and can still be present even though the inverter appears to be switched off
- The motor's direction of rotation might not be controlled
- The motor speed might not be controlled
- The motor might be energised

An inverter is a component within an inverter system that may influence its operation or effects under a fault condition. Consideration must be given to:

- Stored energy
- Supply disconnects
- Sequencing logic
- Unintended operation

Chapter 2: Introduction

About this Manual

Who is this Manual aimed at?

This Manual is intended for use by the user and programmer of the AC30 series inverters. It assumes a reasonable level of understanding in these two disciplines.

There are separate hardware installation references - HA503711U001 'AC30 Series Hardware Installation Manual: Frames D - J' and HA503711U002 'AC30 Series Hardware Installation Manual: Frames K - N' that are intended for use by the installer of the AC30 series inverters.

Note: It is important to always pass on this Manual to any new user of the AC30 series inverter.

How the Manual is Organised?

This Software Reference Manual is organised into chapters, indicated by the numbering on the edge of each page. If the manual is to be printed it is designed so that it should be printed double-sided using the short-edge for binding.

Information for the operation and programming of the AC30V, AC30P, AC30D & AC30A control modules is detailed in this Manual. The control module must be mounted on any one of the Frame D, E, F, G, H, J, K, L, M & N power stacks for intended operation. These two components – control module and power stack, are collectively referred to as “the Inverter” or “drive” throughout the manual.

Product coding: Any “x” within a product code indicates there are variants, see the ‘Appendix D: AC30 Series Product Codes’ section for more information.

AC30P
AC30D
AC30A

Any text placed in a highlighted area as this sample shows, only refers to the AC30P, AC30D and AC30A control modules.

Parker Hannifin Manufacturing Limited is referred to as “Parker” throughout the manual.



IMPORTANT

Please read all Safety information before proceeding with the operation of this unit.



2-2 Introduction

Initial Steps

Use the manual to help you plan the following:

Operation

Know your operator:

- how is it to be operated, local and/or remote?
- what level of user is going to operate the unit?
- decide on the best menu level for the Graphical Keypad (GKP) where supplied.

Programming: Use of the Parker Drive Quicktool or Parker Drive Developer (pc programming tools)

Know your application:

- Download either the Parker Drive Quicktool (PDQ) or Parker Drive Developer (PDD) from:
<http://www.parker.com/eme/ac30>
 - The PDQ is a simple tool aimed at the initial setup and commissioning of a single AC30 inverter.
 - The PDD is a full development tool that allows users to develop their own multi drive configurations.
- Once downloaded, install on your pc.
- Connect your pc to your AC30 inverter via the Ethernet connection.
- Setup and commission your AC30 inverter with the PDQ wizard (refer to 'Chapter 6: Setup Wizard'), or develop your own drive configurations with the PDD tool.
- Refer to 'Appendix C: Parameter Reference' for more information.

PC Requirements

Minimum system requirements:

- 1GB RAM
- 1GHz Pentium
- 1GB free Hard Disk space
- 1024x768 screen resolution

Operating Systems:

- Windows 7 (32 & 64 bit)
- Windows 8 (32 & 64 bit)
- Windows 10 (32 & 64 bit)

Chapter 3: **Product Overview**

Product Range

Power Stacks – Frame Sizes D, E, F, G, H, J, K, L, M & N

Control Modules – AC30V, AC30P, AC30D & AC30A

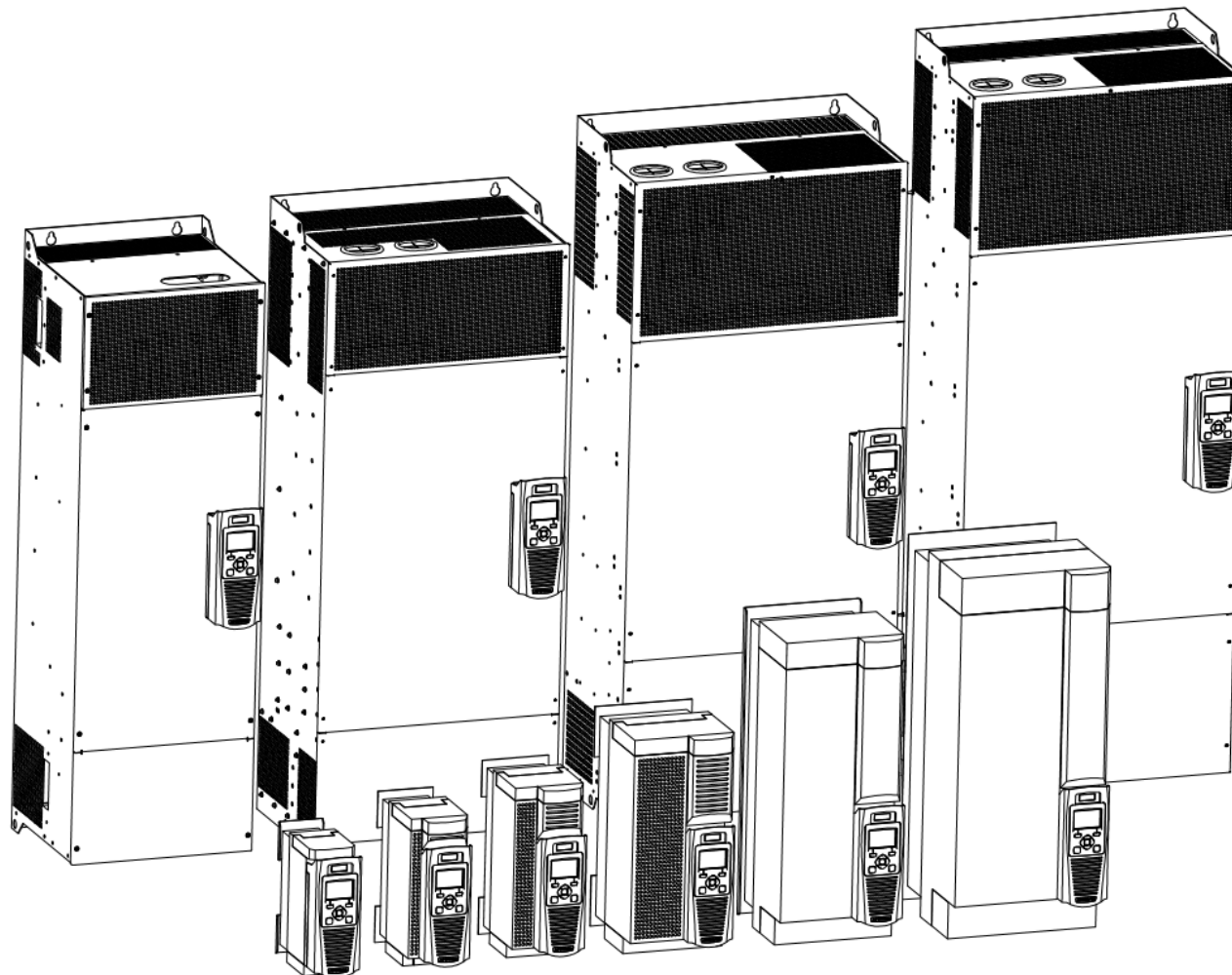

3-2 Product Overview

Power Stack Features

General	Switching Frequency	Minimum 2kHz Default 2kHz (Frames K, L, M & N), 2.5kHz (Frames H & J), 3kHz (Frame G), 4kHz (Frames D, E & F) Maximum 12kHz (Frames D, E, F & G), 9kHz (Frames H, K, L & M), 8kHz (Frames J & N) Derating of output current will apply above the default switching frequency.
	Output Frequency	Maximum is Switching Frequency divided by 8. This is limited to 590Hz due to export rules. e.g. for 4kHz switching frequency it is $4000/8 = 500\text{Hz}$ Maximum is Switching Frequency divided by 6, in PMAC Motor Closed Loop Control. If >590Hz is required, please contact your local Parker Sales representative.
	Dual Rating	Normal duty (ND) Heavy duty (HD)
Stack Protection	Trip Conditions	Output scct: line-to-line & line-to-earth Overcurrent: <ul style="list-style-type: none"> - Frames D, E, F, G, H, J & K 220% HD current / Stall - Frames L, M & N 190% HD current / Stall Overvoltage & undervoltage Heatsink over-temperature Internal over-temperature (Frames J, K, L, M & N only) Output current imbalance (Frames L, M & N only) Missing output current sensor (Frames J, K, L, M & N only) Missing line phase (Frames K, L, M & N only) Motor Thermistor over-temperature (using GPIO option) Dynamic Brake scct protection (Frames D, E, F, G, H, J & K only)
	Current Limit	Adjustable 110% (ND) or 150% (HD) for 60s 180% shock load limit (Heavy Duty) Inverse Time
	Overload Rating	ND - 110% overload for 60s HD - 180% overload for 3s (Frames D, E, F, G, H, J & K only), 150% overload for 60s
User Terminals	Line Input	3 AC input terminals L1, L2, L3 (710 stacks only)
	Motor Output	3 AC output terminals - M1, M2, M3 (to be used as line supply connections for AFE applications)
	PE	2 protective earth terminals
	DC Input	2 DC input terminals DC+ and DC-
	Brake Output	2 DC output terminals DB+ and DB to be used when connecting up a Dynamic Brake Resistor (Frames D, E, F, G, H & J only) 1 DC output terminal DB to be used in conjunction with DC+ when connecting a Dynamic Brake Resistor (Frame K only)

Functional Overview

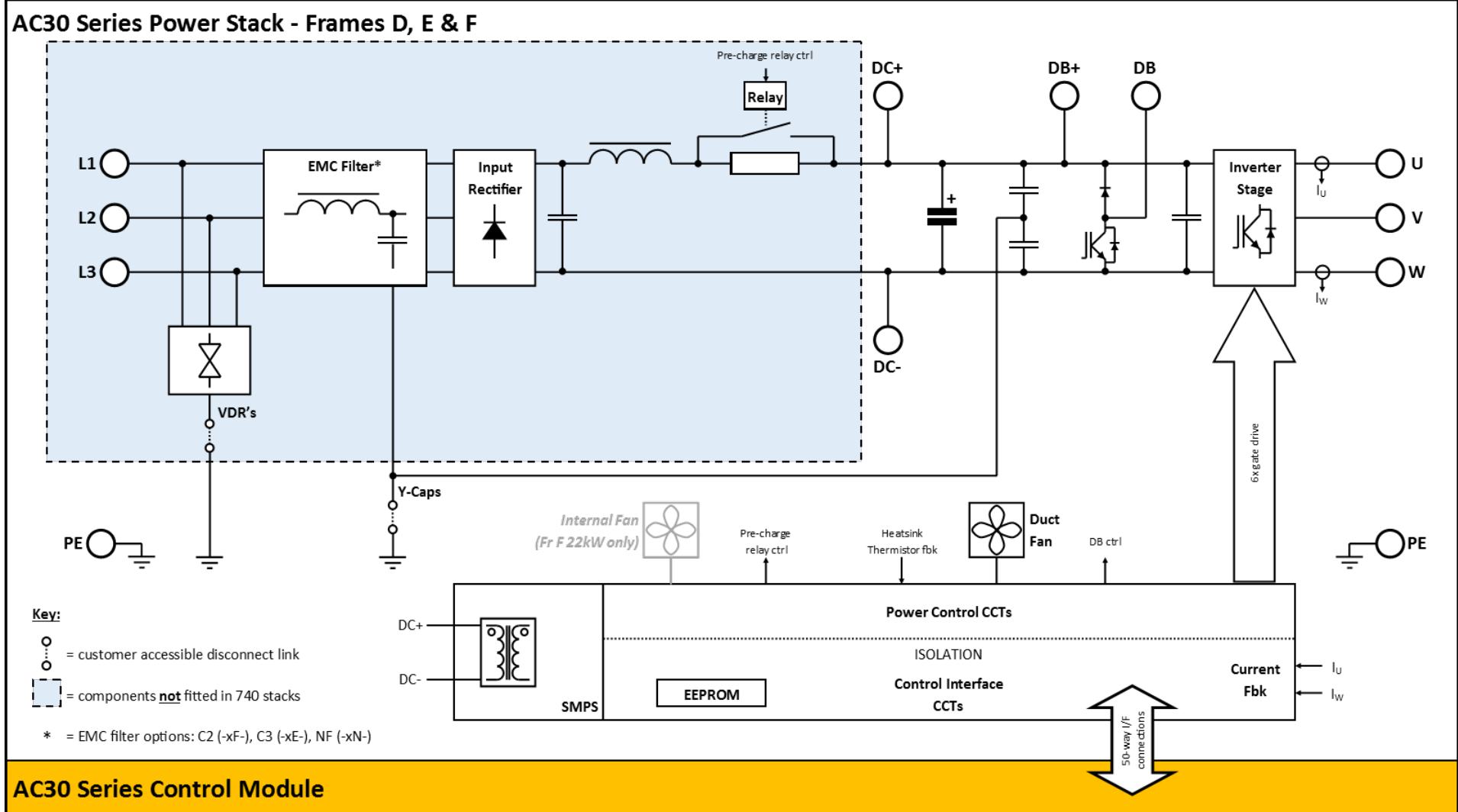

Block Diagram for Frames D, E, F

3-4 Product Overview

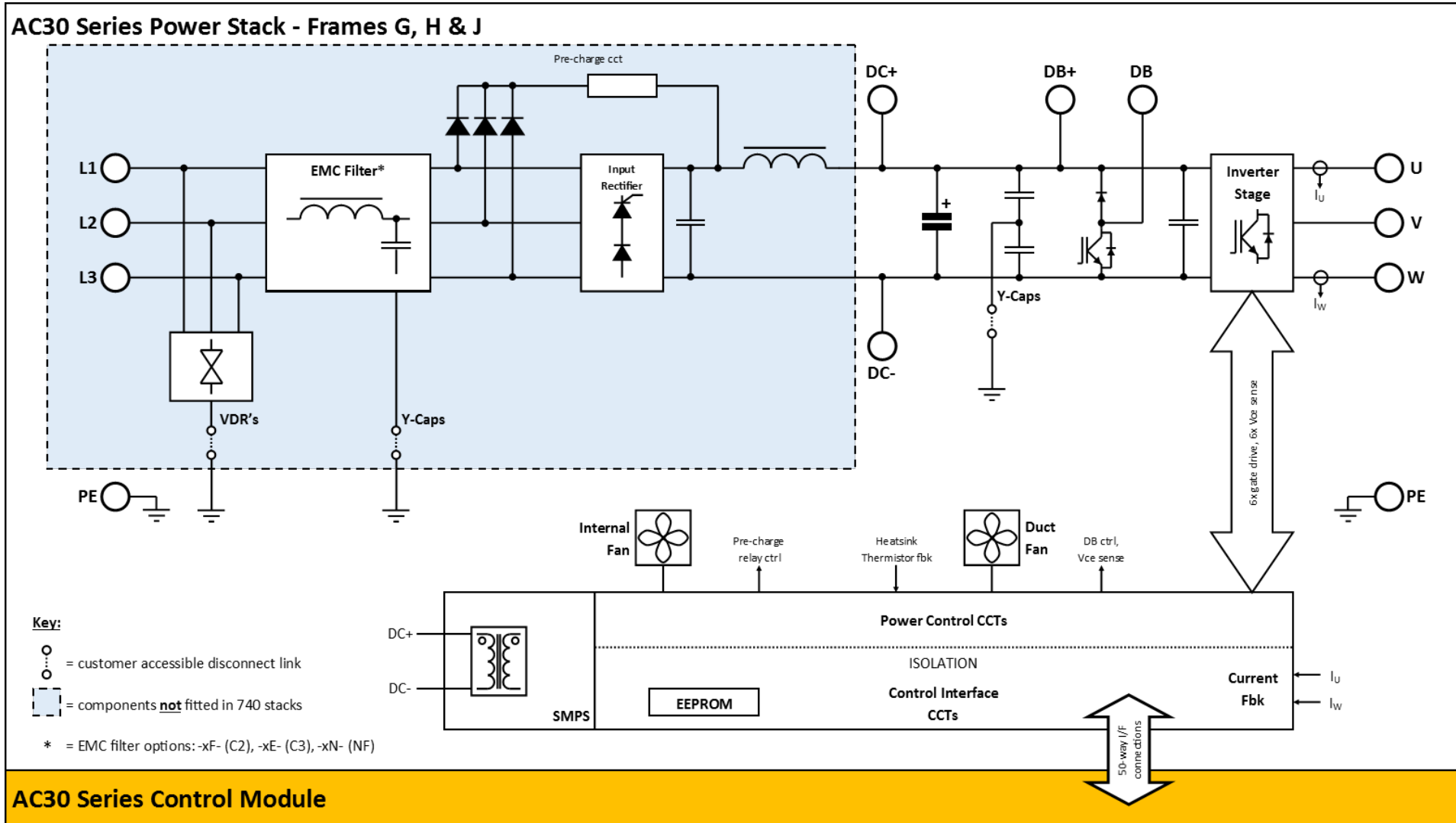

Block Diagram for Frames G, H, J

AC30 Series Power Stack - Frame K

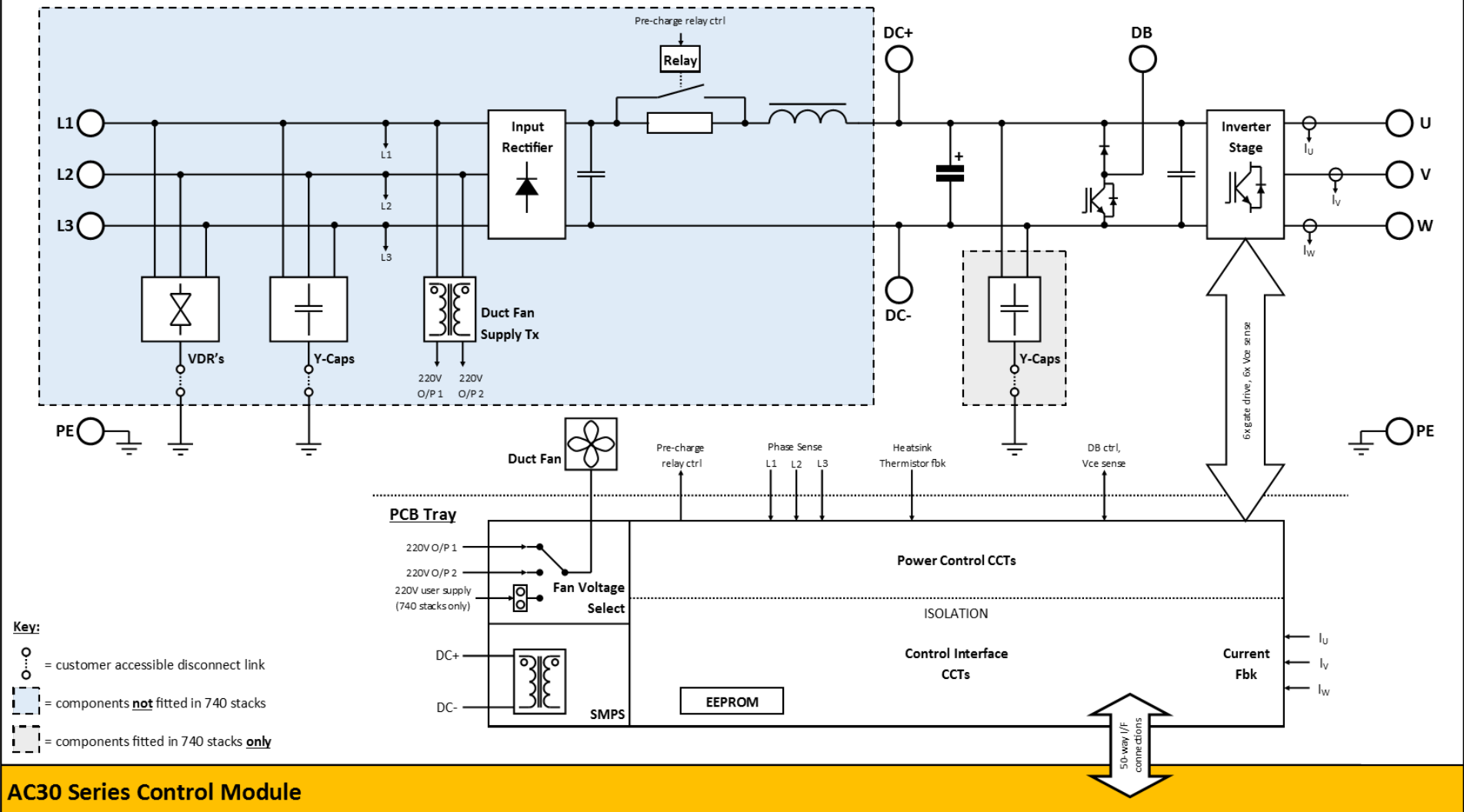

Block Diagram for Frame K

3-6 Product Overview

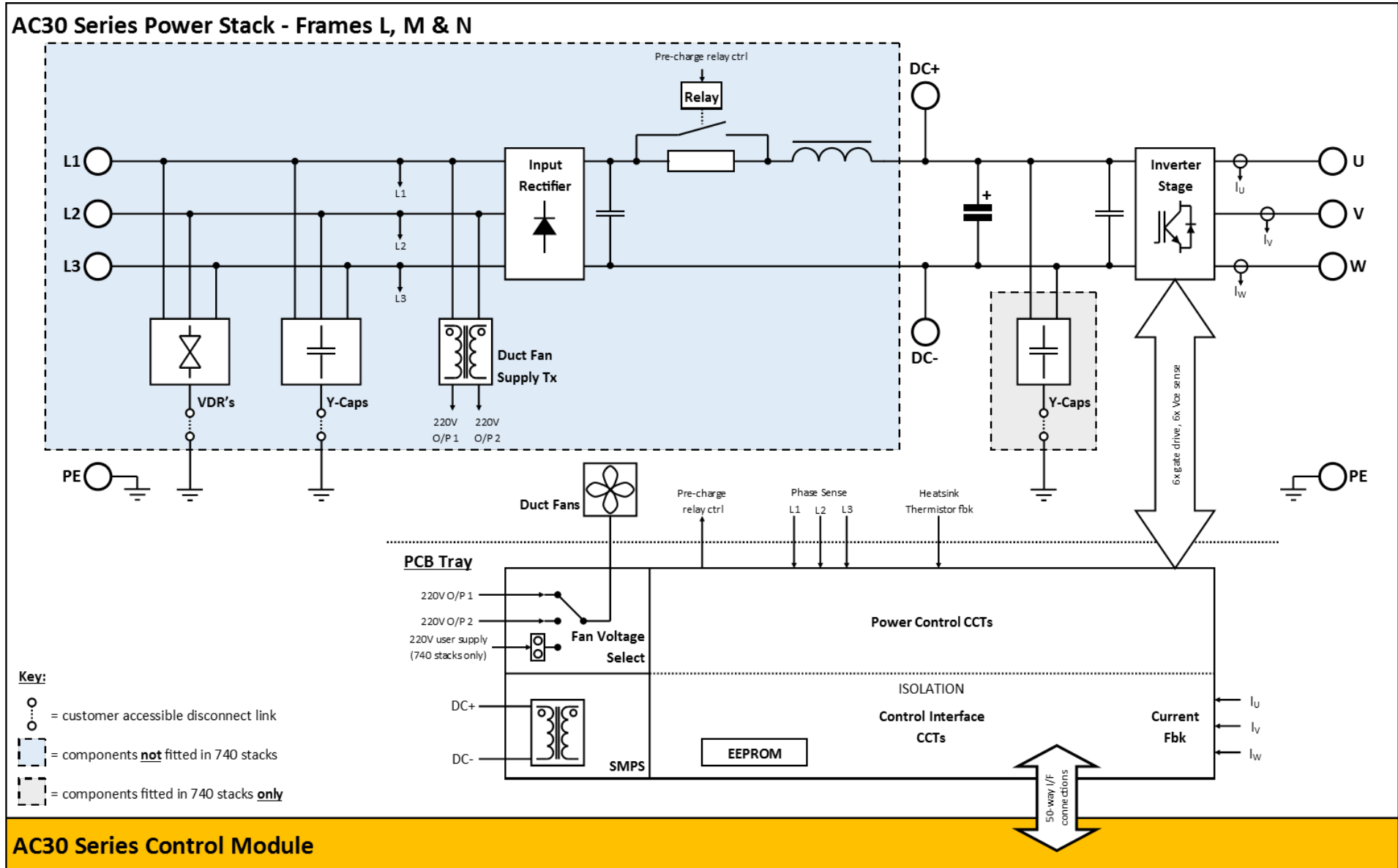

Block Diagram for Frames L - N

AC30 Series Control Features

The inverter is fully featured when controlled using the optional Keypad (or a suitable pc programming tool).

General	Motor Control Modes	Induction motor: <ul style="list-style-type: none"> - V/F control - Sensorless Vector Control - Closed Loop Vector Control (with encoder option) - Closed Loop Vector Control (with resolver option) PMAC motor: <ul style="list-style-type: none"> - Sensorless Vector Control - Closed Loop Vector Control (with encoder option) - Closed Loop Vector Control (with resolver option), though with power constraints 	
	AFE Mode	4Q Regen Control (with encoder option)	
	Voltage Boost for V/F control	0-25%	
	Skip Frequencies	Skip frequencies with adjustable skip band width	
	Preset Speeds	User selectable preset speeds	
	Stopping Modes	Ramp, Coast, DC Injection, Quickstop	
	S Ramp and Linear Ramp	Symmetric or asymmetric ramp up and down rates	
	Raise/Lower	Programmable MOP function	
	Jog	Programmable jog speed	
	Diagnostics	Full diagnostic and monitoring facilities	
	Inputs/ Outputs	Analog Inputs	2 configurable inputs: 1 voltage or current, 1 voltage only
		Analog Outputs	2 configurable outputs: 1 unipolar voltage or current, 1 bipolar voltage only
		Digital Inputs	3 configurable 24V dc inputs
		System Board Digital Inputs	3 configurable 24V dc inputs (AC30D & AC30A only)
Digital I/O		4 configurable 24V dc current sourcing outputs/digital inputs	
System Board Digital I/O		3 configurable 24V dc current sourcing outputs/digital inputs (AC30A only)	
Relay Outputs		2 configurable relay outputs (AC30V only)	
Reference Voltages		+/-10V dc outputs, user +24V dc output	
Aux Supply		+24V dc input	
Encoder Inputs		2 separate encoder input channels: A, /A, B, /B, Z, /Z (AC30D only) 1 sin/cos encoder input channel: sin+, sin-, cos+, cos-, Z, /Z & 1 Endat 2.1 encoder input channel: Data+, Data-, Clock+, Clock- (AC30A only)	
Encoder Supply Outputs	1 selectable encoder output supply voltage (AC30D & AC30A only)		
Encoder Outputs	1 encoder transmit channel: A, /A, B, /B, Z, /Z (AC30D & AC30A only)		
Comms	On-board Ethernet	1 port (AC30V only) 2 ports	

3-8 Product Overview

Chapter 4: The Graphical Keypad



The inverter is fitted with a Graphical Keypad referred to throughout as GKP.

It provides for local control of the inverter, monitoring, and complete access for application programming.

Insert the Keypad into the front of the inverter (replacing the blank cover); or if supplied separately to be used remotely, up to 3 meters away, use the mounting kit with connection lead.

4-2 The Graphical Keypad

Overview









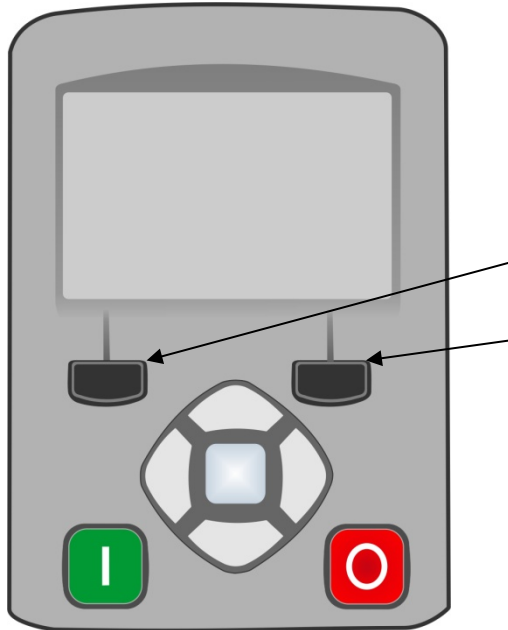

- The top line of the display is used to show the inverter status
- The central region of the display shows the selected parameters or navigation menu
- The bottom line of the display indicates the action associated with the soft keys
- The actions of the soft keys are context dependent
- The central navigation and editing keys are referred to as UP, DOWN, LEFT, RIGHT and OK
- The Run, (green), and Stop, (red), keys are used to start and stop the motor when the inverter is in local control mode.

Keypad

The GKP has a total of nine keys. They can be divided into three groups:

1. Operation keys (LED illuminated pushbuttons)
2. Soft keys
3. Navigation / Editing keys



Key	Function	
Operating Keys (only active when Local control mode is active)		
	RUN	Runs the inverter.
	STOP	Stops the inverter when running / Resets or Acknowledges trips.
Soft Keys (function changes depending on which screen is displayed)		
	Soft Key 1	Return / Abort / Setup Wizard shortcut
	Soft Key 2	Locks password / Save changes / Toggles between 'Local' or 'Remote' control mode / Changes motor rotation direction ('Local' control mode only) / Add or Removes parameters to or from the 'Favourites' menu.
Navigation / Editing Keys		
	OK	Enters into the next menu level or parameter / Enters into parameter edit mode / Accepts the value of the parameter being edited / Displays parameter information (key press held >1s) / Selects parameter as default at power up (key press held >2s)
	UP	Moves 'up' through the parameters of the menu list / Increments the value of the parameter being edited.
	DOWN	Moves 'down' through the parameters of the menu list / Decrements the value of the parameter being edited.
	LEFT	Moves 'back' to the previous menu list / Selects the digit of the parameter being edited.
	RIGHT	Moves 'into' the next menu list or parameter / Selects the digit of the parameter being edited.

4-4 The Graphical Keypad

LED Status Indication

The GKP has two LED illuminated pushbuttons – the green 'Run' key and the red 'Stop' key.

The status of each of these LED illuminated pushbuttons indicates the real time operation of the inverter:

LED Status		Inverter Status:	
Run Key	Stop Key		
OFF	ON	STOPPED	
ON	OFF	RUNNING	
OFF	FLASHING	STOPPING	
FLASHING	OFF	AUTO RESTART PENDING	
FLASHING (IN SYNC)		NOT IN AN OPERATIONAL STATE	
FLASHING (ALTERNATING)		FAULT STATE	

Note: The LED operation can be over-ridden by the application.

The Display

The display is divided into three areas:

1. Top line: shows a summary of the inverter status.
2. Centre region: is the main work area where menus and parameters are displayed.
3. Bottom line: is used to indicate the action associated with the soft keys.

Top Line - Inverter Status Summary

The top line of the display shows a summary of the inverter status. This is divided into four regions. Each region is dedicated to a particular status indication, as shown.

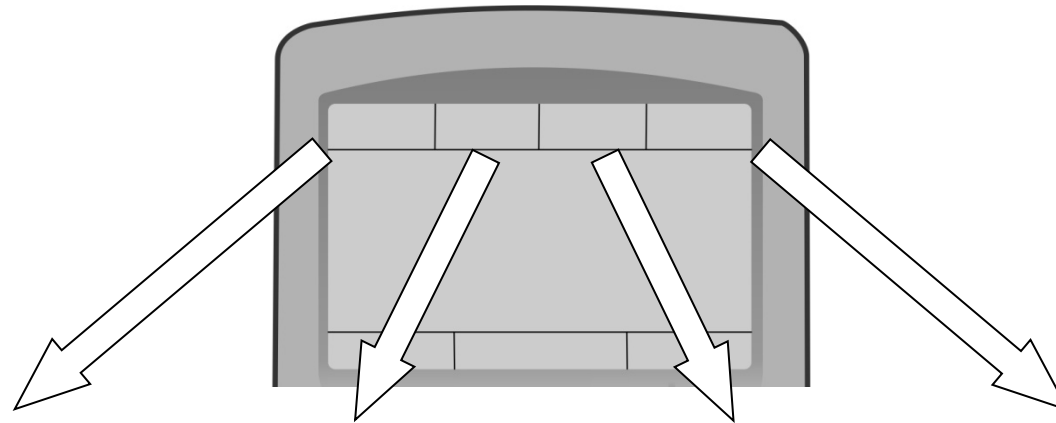



Run, stop and direction		Trip		Ethernet		Control Source	
Running +ve direction		Inverter Tripped	! (flashing)	IP address missing	 (flashing)	Local: Start / Stop from GKP	
Running -ve direction		Warning	! (solid)	IP address configured	 (solid)	Remote: Start / Stop from control terminals	
Stopped (ready to run in +ve direction)		Maintenance required		IP Address configured, PTP clock synchronised		Comms: Start / Stop from comms master	
Stopped (ready to run in -ve direction)							







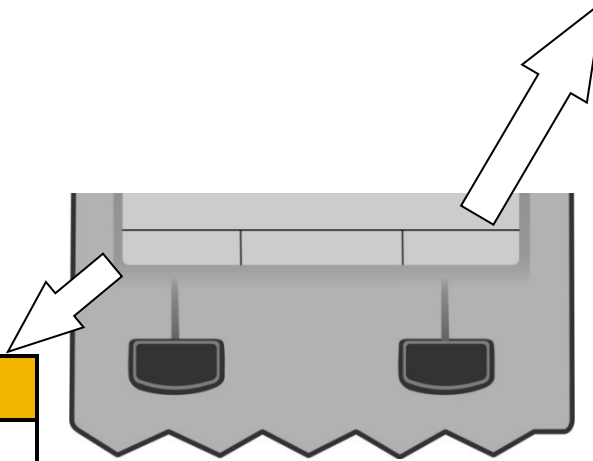

4-6 The Graphical Keypad

Bottom Line – Soft Key Action Indication

The bottom line of the display indicates the action of the Soft Key 1 and Soft Key 2 pushbuttons, as shown.

Soft Key 1	
<p>Return</p> <p><i>Displayed:</i> when navigating through the menus.</p> <p><i>Soft key action:</i> Moves 'back' to the previous menu level.</p>	
<p>Abort</p> <p><i>Displayed:</i> when editing a parameter value.</p> <p><i>Soft key action:</i> Discards change to parameter value.</p>	
<p>Setup Wizard</p> <p><i>Displayed:</i> when on the GKP welcome page.</p> <p><i>Soft key action:</i> Enters into the setup wizard.</p>	



Soft Key 2	
<p>Lock parameters</p> <p><i>Displayed:</i> when on the GKP welcome page.</p> <p><i>Soft key action:</i> Resets GKP password entered, 'locking' all the parameters.</p>	
<p>Save parameters</p> <p><i>Displayed:</i> when on the GKP welcome page.</p> <p><i>Soft key action:</i> Saves all parameters.</p>	
<p>'Local'/'Remote' control mode</p> <p><i>Displayed:</i> while navigating menus or parameters.</p> <p><i>Soft key action:</i> Toggles between 'Local' and 'Remote' control modes.</p>	
<p>Change direction</p> <p><i>Displayed:</i> while navigating menus or parameters.</p> <p><i>Soft key action:</i> Toggles direction between '+ve' and '-ve' speed setpoint.</p>	
<p>Toggles parameter assigned to 'Soft Key 2'</p> <p><i>Displayed:</i> while navigating menus or parameters.</p> <p><i>Soft key action:</i> Toggles between '0' and '1' control modes. Present value '0'.</p>	
<p>Toggles parameter assigned to 'Soft Key 2'</p> <p><i>Displayed:</i> while navigating menus or parameters.</p> <p><i>Soft key action:</i> Toggles between '0' and '1' control modes. Present value '1'.</p>	
<p>Add to 'Favourites' menu</p> <p><i>Displayed:</i> while viewing parameter attributes.</p> <p><i>Soft key action:</i> Adds parameter to the 'Favourites' menu.</p>	
<p>Remove from 'Favourites' menu</p> <p><i>Displayed:</i> while viewing parameter attributes.</p> <p><i>Soft key action:</i> Removes parameter from the 'Favourites' menu.</p>	

The Menu System

Navigating the Menu System

The Menu System can be thought of as a map which is navigated using the direction keys.

- Use the left and right keys to navigate through the menu levels.
- Use the up and down keys to scroll through the Menu and Parameter lists

Menus can contain sub-menus or a list of parameters.

The keys can be used as above to select a parameter. A parameter has a selection, (ie: TRUE / FALSE), or a value displayed below the parameter name.

HINT: Remember that because the Menu and Parameter lists are looped, the UP key can quickly move you to the last Menu or Parameter in the loop. The keys will repeat if you hold them down. This is an easy way to step through and view a menu's contents.

Read-only Parameter Indication

A ':' symbol to the left of the parameter value. indicates that a parameter is read-only.

Changing a Parameter Value

With the parameter you want to change selected, press the center OK key to change to Edit mode. In this mode the arrow keys now perform different functions.

- Change a selection, (i.e. TRUE / FALSE) using the UP and DOWN keys.
- Change a value as follows:
 - The UP and DOWN keys increment / decrement the selected digit.
 - The LEFT and RIGHT keys move the digit selection.
 - The selected digit is indicated by the cursor.

The UP and DOWN keys will repeat if you hold them down.

When changing a value, if the abort icon () is shown over Soft Key 1, pressing this key will abort the edit, leaving the value unchanged.

To accept the edited value, press the center OK key.

Refer to Chapter 5 for a description of the menu items

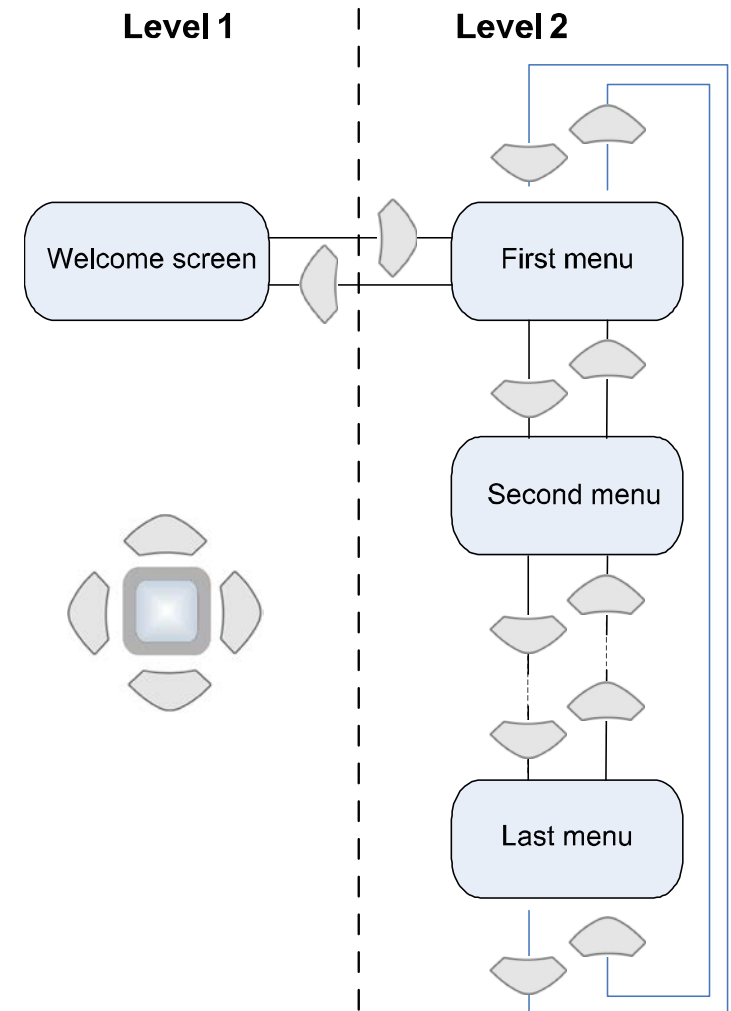

4-8 The Graphical Keypad

Trips and other information displays

An information message will be displayed when the unit is tripped. To clear the message from the display, press Soft key 1.

To reset the trip, allowing the inverter to respond to a start command, press the STOP key. See Chapter 10 Trips & Fault Finding.

Setting the display language

The GKP supports multiple languages. The language to be used may be selected as the second entry in the GKP Wizard, (see chapter 9). The language is also available as a parameter **1005 Language**.

When changing language, there may will be a short delay while the updated text is transferred to the GKP. During this period the GKP will be unresponsive. An information message “UPDATING LANGUAGE” is displayed during this process.

The GKP has the following language files built in as standard:

- English
- French
- German
- Spanish
- Italian

Setup Wizard

The purpose of the Setup Wizard is to configure the inverter in a clear and concise manner.

Starting the Setup Wizard

The Setup Wizard is automatically invoked when the inverter is reset to factory default settings.

Alternatively, the Setup Wizard may be invoked at any other time by navigating to the 'Welcome Screen' at the top of the menu tree and pressing Soft Key 1, as shown by the Setup Wizard  indicator.

Note: It is always recommended that the Setup Wizard is completed once started.

Navigating the Setup Wizard

At each step of the Setup Wizard, pressing the OK key selects the displayed value and also moves on to the next step.

Pressing Soft Key 1 moves back a step.

Pressing the UP and DOWN keys modifies the parameter value.

Note: Accepting each choice without change by pressing OK will result in no change to the inverter's configuration.

Setup Wizard Stages

The Setup Wizard starts by asking what user view level is required for the GKP, followed by a list of languages for which the user selects their preference.

The user will then be asked if they would like to continue and run the Wizard. If 'yes', the first option is to "Set Factory Defaults". Changing this parameter to TRUE then pressing OK resets all parameters back to the default value determined by the inverters hardware configuration. In most case, this is recommended. If this choice is left FALSE the setup wizard starts with all parameters with their previously set values.

The rest of the Setup Wizard consists of several sections, each of which corresponds to a functional component of the inverter, for example:

- Application selection
- IO Option, (includes the Encoder)
- Analog input and output ranges.
- Motor Data
- Motor Control
- Fieldbus options
- On-board Ethernet
- Auto tune

If not required, any section may be skipped.

The default setting for all parameters depends on earlier answers and on the physical configuration of the inverter. All data entered is automatically saved without the need for any additional commands.

Finalising Setup

Once the Setup Wizard has been run to completion, the feature is automatically disabled. Power cycling to the inverter will not cause the Setup Wizard to be run again, though If this is required, this can be achieved as detailed above in 'Starting the Setup Wizard'.

Refer to chapter 6 for a more detailed explanation of the Setup Wizard

4-10 The Graphical Keypad

Firmware Update

The inverter firmware will need to be updated in order to take advantage of new product features, bug fixes or new hardware support. To do this:

Prepare the SD card

Download the latest AC30 firmware from the Parker website:

<http://www.parker.com/eme/ac30>

Alternatively, the latest firmware can be copied through the Parker Drive Quicktool (PDQ), using the 'Drive Maintenance' task.

Copy the firmware onto an SD card. The file must be named **firmware.30x** for the AC30V, or **firmware.30p** for the AC30P and AC30D.

Install the SD card

Insert the SD card into the slot in the upper moulding of the control module.

Perform the Firmware upgrade

With the SD card installed in the AC30 control module, navigate to the 'Setup Wizard' as detailed on page 9-6. There will now be an additional 'Update Firmware' step as the user goes through the Setup Wizard process.

To start the update, change the value from FALSE to TRUE. The 'Firmware Update In Progress' message will appear, followed by an egg timer.

CAUTION: DO NOT REMOVE POWER FROM THE INVERTER DURING THE FIRMWARE UPDATE.

The inverter will restart once the process is complete and return to the normal menu screen.

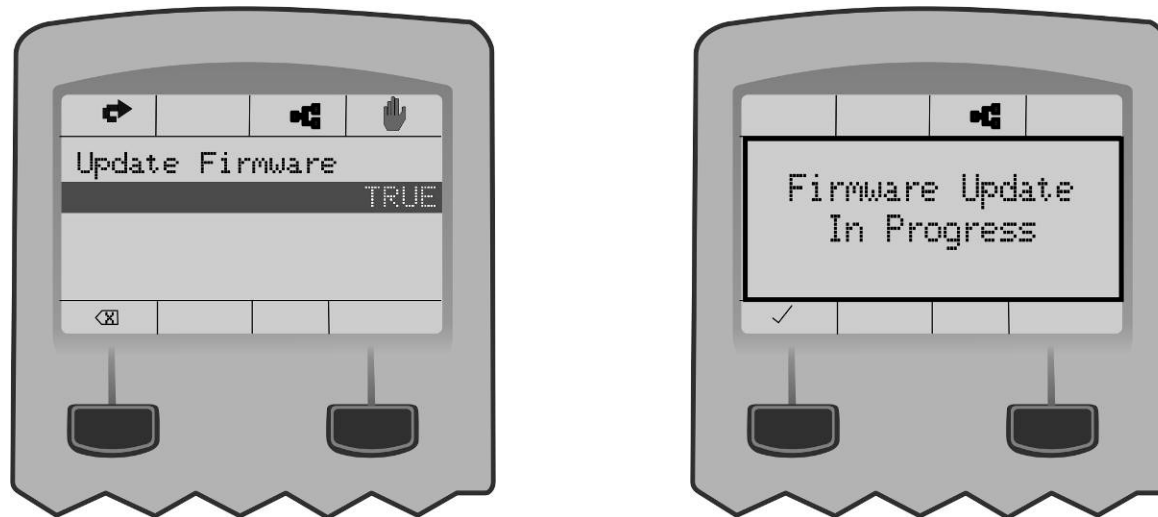

Chapter 5: Menu Organisation

Menu Map

The Menu System consists of a series of menus and sub-menus organised into a “tree” structure. Navigate around the tree on the GKP using the UP, DOWN, LEFT and RIGHT keys. Individual parameters may be present in the menu tree at more than one location. Parameters and/or menus that are not required or are empty are automatically hidden on the GKP and web page.

Menu Map Summary

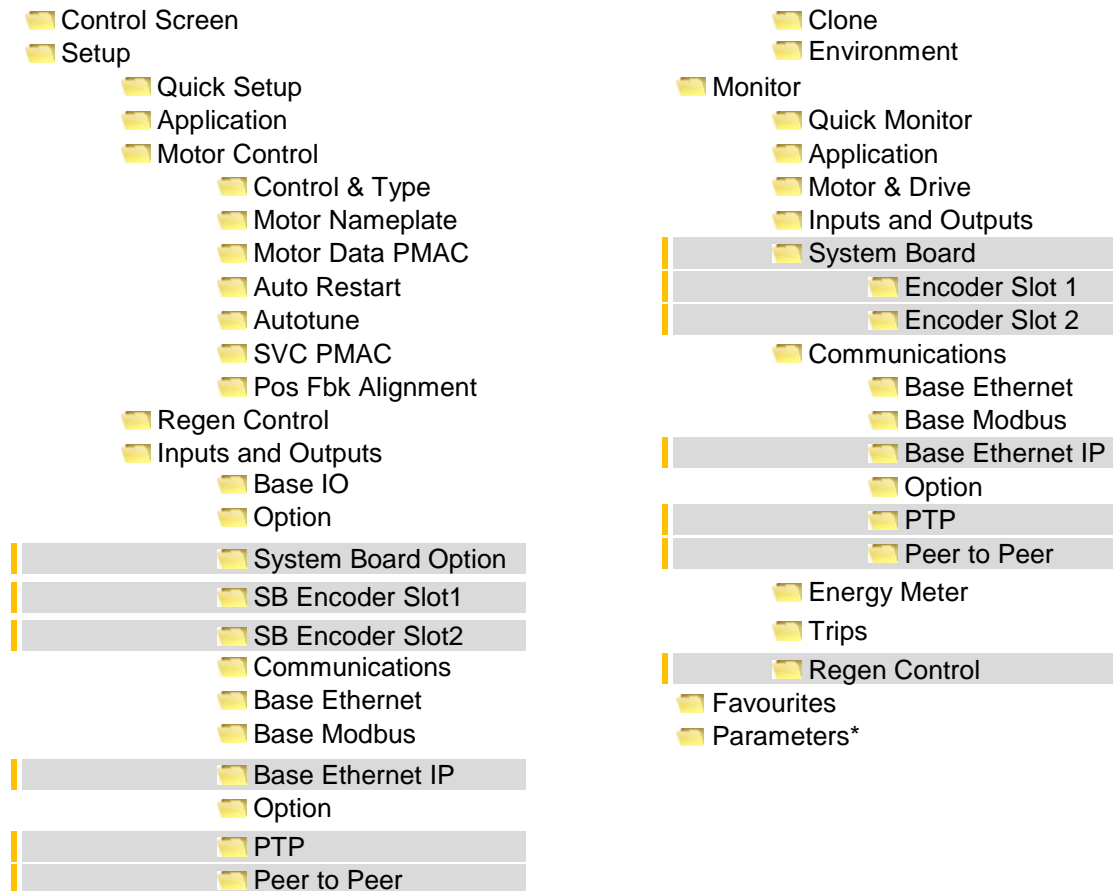

* The “Parameters” menu is intended for expert use only, see Appendix D

5-2 Menu Organisation

Menu Descriptions

Control Screen

In local sequencing mode the Control Screen menu shows the Local Setpoint, the Seed Feedback and configuration of the action of the Run key and direction. When the inverter is not in local sequencing mode this menu shows the operating speed. The contents of the Control Screen can be modified by the configuration.

Setup

Parameters that may require modification once the Setup Wizard is complete.

Monitor

This menu contains parameters commonly used to verify the correct operation of the inverter and the process.

Favourites

The Favourites menu contains up to 20 parameters selected for ease of access.

To Add a Parameter to the Favourites Menu

Using the GKP, navigate to the parameter of interest.
Press and hold the OK key until the Attributes screen is shown, (hold for about 2s)
then this appears  + and press the “Add to Favourites” soft key.

To Remove a Parameter From the Favourites Menu

Using the GKP navigate to the parameter of interest in the Favourites menu.
Press and hold the OK key until the Attributes screen is shown, (hold for about 2s).
Press the “Remove from Favourites” soft key, .

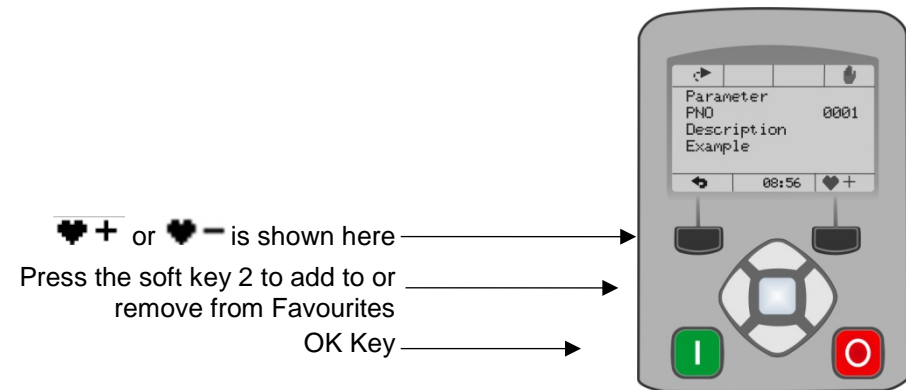

Parameters

A complete collection of all the parameters in the inverter. This menu is intended for expert use.

Parameter Map

The following table shows the parameters as they appear in order on the Web page and GKP. Also shown is the Parameter Number, PNO. This is a unique reference for each parameter. For more details about each parameter refer to Appendix C.

<ul style="list-style-type: none"> Control Screen Setup <ul style="list-style-type: none"> Quick Setup Application Motor Control <ul style="list-style-type: none"> Control and Type <table border="0" style="width: 100%;"> <tr><td>Motor Type or AFE</td><td>0511</td><td>PMAC Winding Resistance</td><td>0561</td></tr> <tr><td>Control Strategy</td><td>0512</td><td>PMAC Winding Inductance</td><td>0562</td></tr> <tr><td>Control Type</td><td>1533</td><td>PMAC Torque Const KT</td><td>0563</td></tr> <tr style="background-color: #e0e0e0;"><td>Encoder Feedback</td><td>1743</td><td>PMAC Encoder Offset</td><td>1808</td></tr> <tr><td>100% Speed in RPM</td><td>0464</td><td>PMAC Wiring</td><td>1809</td></tr> <tr><td>Acceleration Time</td><td>0486</td><td>PMAC Therm Time Const</td><td>0565</td></tr> <tr><td>Deceleration Time</td><td>0487</td><td>PMAC Motor Inertia</td><td>0564</td></tr> <tr><td>Current Limit</td><td>0305</td><td>Auto Restart <ul style="list-style-type: none"> AR Enable</td><td>1469</td></tr> AR Mode</table>	Motor Type or AFE	0511	PMAC Winding Resistance	0561	Control Strategy	0512	PMAC Winding Inductance	0562	Control Type	1533	PMAC Torque Const KT	0563	Encoder Feedback	1743	PMAC Encoder Offset	1808	100% Speed in RPM	0464	PMAC Wiring	1809	Acceleration Time	0486	PMAC Therm Time Const	0565	Deceleration Time	0487	PMAC Motor Inertia	0564	Current Limit	0305	Auto Restart <ul style="list-style-type: none"> AR Enable	1469	1470
Motor Type or AFE	0511	PMAC Winding Resistance	0561																														
Control Strategy	0512	PMAC Winding Inductance	0562																														
Control Type	1533	PMAC Torque Const KT	0563																														
Encoder Feedback	1743	PMAC Encoder Offset	1808																														
100% Speed in RPM	0464	PMAC Wiring	1809																														
Acceleration Time	0486	PMAC Therm Time Const	0565																														
Deceleration Time	0487	PMAC Motor Inertia	0564																														
Current Limit	0305	Auto Restart <ul style="list-style-type: none"> AR Enable	1469																														
Main Torque Lim	0417	Autotune <ul style="list-style-type: none"> Autotune Enable	0255																														
Seq Stop Method SVC	1257	SVC PMAC <ul style="list-style-type: none"> PMAC SVC Start Cur	0478																														
Seq Stop Method VHz	0484	Pos Fbk Alignment <ul style="list-style-type: none"> Alignment Enable	1798																														
Stop Ramp Time	0504	Regen Control <ul style="list-style-type: none"> Motor Type or AFE	0511																														
VHz Shape	0422																																
Fixed Boost	0447																																
Duty Selection	0390																																

- Motor Nameplate

Base Frequency	0457		
Rated Motor Current	0455		
Motor Poles	0458		
Base Voltage	0456		
Nameplate Speed	0459		
Power Factor	0461		
Motor Power	0460		
- Motor Data PMAC

PMAC Max Speed	0555		
PMAC Max Current	0556		
PMAC Rated Current	0557		
PMAC Rated Torque	0558		
PMAC Motor Poles	0559		
PMAC Back Emf Const KE	0560		
PMAC Base Volt	1387		

Menu Organisation 5-4

AFE Iq Demand	1705
AFE Id Demand	1704
Inputs and Outputs	
Base IO	
Anin 01 Type	0001
Anin 01 Offset	0957
Anin 01 Scale	0958
Anin 02 Type	0002
Anin 02 Offset	0959
Anin 02 Scale	0960
Anout 01 Type	0003
Anout 01 Scale	0686
Anout 01 Offset	1108
Anout 01 ABS	1441
Anout 02 Type	0004
Anout 02 Scale	1460
Anout 02 Offset	1467
Anout 02 ABS	1468
Option	
Option IO Required	1178
Thermistor Type	1184
Encoder Supply	1511
Encoder Lines	1512
Encoder Invert	1513
Encoder Type	1514
Encoder Single Ended	1515
Encoder Count Reset	1517
Resolver Frequency	1791
Resolver Voltage	1790
Resolver Ratio	1792
Resolver Max Speed	1825
Resolver Poles	1793
Resolver Built-In Gear	1822
Resolver Invert	1810
Resolver Speed Filter	1815
Resolver Min Filter	1851
Resolver Resolution	1816
Anin 11 Offset	1461
Anin 11 Scale	1462
Anin 12 Offset	1463
Anin 12 Scale	1464
Anin 13 Offset	1465
Anin 13 Scale	1466
System Board Option	
System Board Required	1739
Output Enable	1678
Output Source	1679
Output Voltage	1680

Output A	1756
Output B	1757
Output Z	1758
Synth Encoder Lines	1696
Synth Encoder Speed	1698
Synth Encoder Invert	1702
SB Encoder Slot1	
Encoder Supply	1663
Encoder Lines	1664
Encoder Invert	1665
Encoder Type	1666
High Input Threshold	1667
Encoder Count Reset	1669
SB Encoder Slot2	
Encoder Lines	1671
Encoder Invert	1672
Encoder Type	1673
High Input Threshold	1674
Encoder Count Reset	1676
Communications	
Base Ethernet	
DHCP	0929
Auto IP	0930
User IP Address	0933
User Subnet Mask	0934
User Gateway Address	0935
Web Access	0944
Base Modbus	
Maximum Connections	0939
High Word First	0940
Modbus Timeout	0941
Modbus Trip Enable	0942
Modbus Mapping[16]	1567
Modbus TCP Password	1659
Base Ethernet IP	
Ethernet IP Enable	3128
Ethernet IP Trip	3129
Input Mapping	3000
Output Mapping	3064
Option	
Comms Required	0044
BACnet MAC Address	1091
BACnet MSTP Device ID	1092
BACnet Baud Rate	1093
BACnet MSTP Timeout	1094
BACnet IP Device ID	0209
BACnet IP Timeout	0210
CANopen Node Address	0212

Menu Organisation 5-5

CANopen Baud Rate	0213
ControlNet MAC ID	0215
DeviceNet MAC ID	0219
DeviceNet Baud Rate	0220
Modbus Device Address	0229
Modbus RTU Baud Rate	0230
Parity And Stop Bits	0231
High Word First RTU	0232
Modbus RTU Timeout	0233
High Word First TCP	0235
Profibus Node Address	0238
Modbus TCP Timeout	0236
Address Assignment	0199
Fixed IP Address	0200
Fixed Subnet Mask	0201
Fixed Gateway Address	0202
Option Web Enable	0203
Web Parameters Enable	0204
Option FTP Enable	0205
Option FTP Admin Mode	0206
IPConfig Enable	0207
Comms Trip Enable	0048
Comms Reset Allow	1853
BACnet Max Master	1095
BACnet Max Info Frames	1096
DNet Producing Inst	0222
DNet Consuming Inst	0223
CNet Producing Inst	0216
CNet Consuming Inst	0217
ENet Producing Inst	0226
ENet Consuming Inst	0227
Modbus Password	1640
Read Mapping[32]	0055
Write Mapping[32]	0120

PTP

PTP Enable	1661
PTP Clock Type	1684
PTP Clock Mode	1683
PTP Domain Number	1787
PTP Log Sync Interval	1681
PTP Priority2	1686
PTP Lock Threshold	1685

Peer to Peer

Peer to Peer Enable	1725
Destination IP Address	1726
Destination Port	1727
Local Port	1728

Clone

Clone Filename	1534
Clone Direction	1537
Full Restore	1538
Application	1539
Power Parameters	1541
Other Parameters	1540
Clone Start	1542
Clone Status	1543

Environment

Drive Name	0961
GKP Password	1142
Web Access	0944
Display Timeout	0983
Startup Page	0982

Monitor

Quick Monitor

Application

Motor and Drive

Actual Speed RPM	0393
DC Link Voltage	0392
Actual Speed rps	0394
Actual Speed Percent	0395
DC Link Volt Filtered	0396
Actual Torque	0399
Actual Field Current	0400
Motor Current Percent	0401
Motor Current	0402
Motor Terminal Volts	0405
Actual Pos Torque Lim	0420
Actual Neg Torque Lim	0421
Heatsink Temperature	0407
CM Temperature	0406
PMAC Wiring	1809

Inputs and Outputs

Digout Value	0022
Digin Value	0005
Anout 01 Value	0042
Anout 02 Value	0043
Anin 01 Value	0039
Anin 01 Break	0040
Anin 02 Value	0041
Anin 11 Value	1181
Anin 12 Value	1182
Anin 13 Value	1183
Encoder Speed	1516
Encoder Count	1518
SB Digital Input 1	1759
SB Digital Input 2	1722

Menu Organisation 5-6

SB Digital Input 3	1723
Resolver Speed %	1814
resolver position	1824
Resolver Turns	1811
Resolver Fraction Turns	1812
System Board	
Encoder Slot 1	
Encoder Speed	1668
Encoder Count	1670
Encoder Slot 1	
Encoder Speed	1675
Encoder Count	1677
Communications	
Base Ethernet	
Ethernet State	0919
MAC Address	0920
IP Address	0926
Subnet Mask	0927
Gateway Address	0928
Base Modbus	
Open Connections	1241
Process Active	0943
Mapping Valid	1632
Base Ethernet IP	
Ethernet IP State	3130
Ethernet IP Diag	3131
Option	
Comms Fitted	0045
BACnet MSTP State	1089
BACnet IP State	0208
Profibus State	0237
EtherNet IP State	0225
Modbus TCP State	0234
Modbus RTU State	0228
EtherCAT State	0224
PROFINET State	0239
PROFINET Device Name	0240
CANopen State	0211
ControlNet State	0214
DeviceNet State	0218
CANopen Actual Baud	1251
DeviceNet Actual Baud	0221
Comms Supervised	0047

Comms Event Active	0186
Option MAC Address	0189
Option IP Address	0195
Option Subnet Mask	0196
Option Gateway	0197
Option DHCP Enabled	0198
Comms Module Version	0049
Comms Module Serial	0050
Comms Diagnostic	0051
Comms Diagnostic Code	0052
Comms Exception	0053
Comms Net Exception	0054
PTP	
PTP State	1689
PTP Clock	1699
PTP Offset	1687
PTP Locked	1688
Peer to Peer	
Peer to Peer State	1729
Energy Meter	
Energy kWh	0383
Power kW	0380
Power HP	0381
Reactive Power	0382
Power Factor Est	0385
Trips	
First Trip	0696
Active 1 - 32	0763
Active 33 - 64	0513
Warnings 1 - 32	0829
Warnings 33 - 64	0514
RTA Code	0998
RTA Data	0999
Regen Control	
AFE Sync Frequency	1703
AFE Status	1721
DC Link Voltage	0392
Favourites	

Chapter 6: Setup Wizard

GKP Setup Wizard

Purpose of the Setup Wizard

The purpose of the setup wizard is to configure the inverter in a clear and concise manner.

First familiarize yourself with Chapter 4 Graphical Keypad, for the keypad functions.

Starting the Setup Wizard

The Setup Wizard is automatically invoked when first powered up. The setup wizard may be invoked at any other time by pressing the set-up key (≡). This is shown on the Welcome Screen, (at the “top” of the MMI menu structure). The Setup Wizard is also invoked by changing the parameter “Run Wizard?” to YES (you will find this under the “Parameters: Device Manager: Setup Wizard” menu).

Running the Setup Wizard

At each point in the wizard pressing the **OK key** selects the displayed value and moves on to the next step.

Pressing **Soft key 1** moves back a step. Pressing the UP and DOWN keys modifies the selected value.

The default setting for all parameters depends on earlier answers and on the physical configuration of the inverter so pressing OK repeatedly will result in no parameter values being altered. All data entered is automatically saved without the need for any additional commands.

Information that you will need in order to set up the motor control

When you run the setup wizard you will be asked for various items of information in order to set up the motor control.

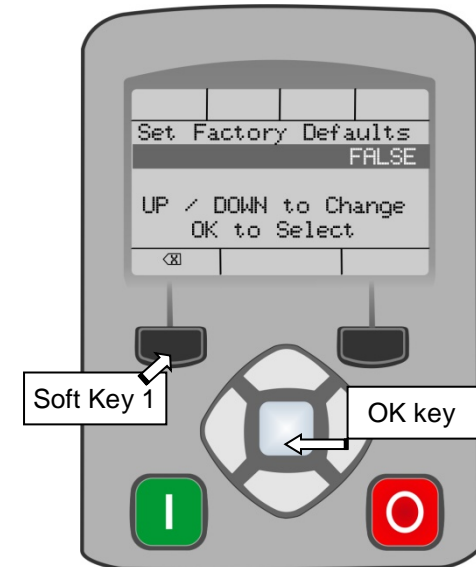

6-2 Setup Wizard

Setup Wizard Stages

The Setup Wizard is divided into sections. With the exception of the first group of parameters, each section may be skipped. The first group of parameters sets the inverter operating environment.

PNO	Parameter	Comment
1141	View Level	Select the view level, Operator, Technician or Engineer.
1005	Language	Select the required language to be used on the GKP. There may be a slight pause while the inverter adopts the selected language.
1002	Update Firmware	Select YES to update the inverter's firmware. Only visible in Engineering view mode with a firmware file on the SD Card.
1006	Run Wizard	Select YES to continue. Select NO to exit with the new settings for View Level and Language
1000	Reset to Defaults	Changing this parameter to TRUE then pressing OK resets all parameters back to the default value determined by the inverters hardware configuration. If this choice is left FALSE all parameters retain their previously set values.
987	Power Stack Required	Only shown if the control module is not attached to a matching power stack.
1186	Time and Date	Only shown if an IO option with RTC hardware is fitted.
0944	Web Access	Set to FULL to allow access to parameter values via the web page.
1738	Enable Auto Save	Set to TRUE to automatically save parameter values as they are entered on the GKP and Web page. Set to FALSE to enable the manual save feature. All parameters are saved on completion of the GKP wizard regardless of the setting of this parameter. Also, this parameter is always saved when changed.
0961	Drive Name	Defaults to show the Ethernet MAC address

6-3 Setup Wizard

Application selection

Selection of the specific Macro and associated parameters.

PNO	Parameter	Validity							Comment
	Setup Application?								Select YES to configure the application parameters, NO to skip this section
1900	Selected Application	BASIC SPEED CONTROL	AUTO/MANUAL CONTROL	SPEED RAISE/LOWER	SPEED PRESETS	PROCESS PID	AFE		
1937	Disable Coast Stop	•	•	•	•	•			
1938	Disable Quickstop	•	•	•	•	•			
1901	RL Ramp Time			•					Sets the rate of change of the output of the Raise/Lower ramp.
1902	RL Reset Value			•					The value of the Raise/Lower ramp output when reset.
1903	RL Maximum Value			•					The upper limit of the Raise/Lower ramp output.
1904	RL Minimum Value			•					The lower limit of the Raise/Lower ramp output
1916	Preset Speed 0				•				The preset speed output when the selected preset is 0.
1917	Preset Speed 1				•				The preset speed output when the selected preset is 1.
1918	Preset Speed 2				•				The preset speed output when the selected preset is 2.
1919	Preset Speed 3				•				The preset speed output when the selected preset is 3.
1920	Preset Speed 4				•				The preset speed output when the selected preset is 4.
1921	Preset Speed 5				•				The preset speed output when the selected preset is 5.
1922	Preset Speed 6				•				The preset speed output when the selected preset is 6.
1923	Preset Speed 7				•				The preset speed output when the selected preset is 7.
1926	PID Setpoint Negate					•			Changes the sign of the setpoint input.
1927	PID Feedback Negate					•			Changes the sign of the feedback input.
1928	PID Prop Gain					•			The proportional gain of the PID controller.
1929	PID Integral TC					•			The integral time constant of the PID controller.
1930	PID Derivative TC					•			The derivative time constant of the PID controller.
1931	PID Output Filter TC					•			The time constant of the first order filter used to filter the PID output.
1932	PID Output Pos Limit					•			The maximum positive excursion, (limit), of the PID controller.
1933	PID Output Neg Limit					•			The maximum negative excursion, (limit), of the PID controller.
1934	PID Output Scaling					•			The overall scaling factor which is applied after the positive and negative limit clamps

6-4 Setup Wizard

Input and Output Option

Configuration of the type and settings for the available IO options.

PNO	Parameter	Comment
	Setup Option IO?	Select TRUE to configure the IO Option. Set to FALSE to skip this section Only shown if an IO option is fitted, or if one has been previously configured.
1178	Option IO Required	Select the required IO Option type.
1184	Thermistor Type	Select the required thermistor type.
1511	Encoder Supply	For the Pulse Encoder option, configures the encoder supply output.
1512	Encoder Lines	For the Pulse Encoder option, configures the number of pulses per revolution
1514	Encoder Type	For the Pulse Encoder option, configures the encoder type
1515	Encoder Single Ended	For the Pulse Encoder option, configures whether the input is single ended or differential.
1791	Resolver Frequency	Frequency of the Resolver excitation in kHz
1790	Resolver Voltage	Voltage supply of the Resolver excitation in Vrms
1792	Resolver Ratio	Resolver Ratio, corresponding to the ratio between excitation voltage and max sin and cos voltages
1825	Resolver Max Speed	Mechanical Resolver max speed in rpm
1793	Resolver Poles	Resolver poles number -Should be an even number
1822	Resolver Built-In Gear	Number of shaft mechanical turns for 1 Resolver turn
1810	Resolver Invert	To change the count direction of the Resolver
1815	Resolver Speed Filter	Speed filter action, in % of the actual speed value in Hz
1851	Resolver Min Filter	Minimum filter value applied to the speed information. The filter value is at least equal to this value
1816	Resolver Resolution	Resolver resolution selection, in bits per electrical turns (eg: 16 bits is 65536 counts per electrical resolver turn)

Analog Input and Output

Configuration of the ranges for the analog inputs and outputs. Also selects the thermistor type if an IO option is fitted.

PNO	Parameter	Comment
	Setup Input/Output?	Select TRUE to configure the analog input and output ranges. Set to FALSE to skip this section
0001	Anin 01 Type	Select the hardware range for analog input 1
0002	Anin 02 Type	Select the hardware range for analog input 2
0003	Anout 01 Type	Select the hardware range for analog output 1
0004	Anout 02 Type	Select the hardware range for analog output 2

6-5 Setup Wizard

Motor Data

Selection of the motor type, control mode and setting the motor control and process control parameters. The Validity column indicates which parameters are shown, dependent on the control mode.

PNO	Parameter	Validity				Comment
		IM VHz	IM VECT	PMAC	AFE	
	Setup Motor?					Select TRUE to configure the motor parameters, FALSE to skip this section
0511	Motor Type or AFE	•	•	•	•	Selects the motor type.
0512	Control Strategy	•	•			Selects between Volts/Hz and Vector Control.
1533	Control Type		•	•		Only visible if Vector Control is selected. Selects between Sensorless Control, and Closed Loop Control (with encoder).
1743	Encoder Feedback		•	•		
0976	Nominal Supply	•	•			Defines the default value for the motor frequency parameters.
0457	Base Frequency	•	•			The base frequency on the motor name plate
0456	Base Voltage	•	•			The rated voltage on the motor name plate
0458	Motor Poles	•	•			The number of motor poles. Always enter an even number.
0455	Rated Motor Current	•	•			Current rating from the motor name plate.
0460	Motor Power	•	•			Power rating from the motor name plate.
0459	Nameplate Speed	•	•			Nominal speed from the motor name plate.
0461	Power Factor	•				Power factor from the motor name plate, (often shown as ϕ). If this is not available then leave this at the default value.
0555	PMAC Max Speed			•		The motor's maximum speed.
0556	PMAC Max Current			•		The motor's maximum current
0557	PMAC Rated Current			•		The motor's rated current.
0558	PMAC Rated Torque			•		The motor's rated torque
0559	PMAC Motor Poles			•		The number of motor poles. Always enter an even number.
0560	PMAC Back EMF Const KE			•		The motor's Back EMF line to line, rms value (Ke, Volts rms per 1000 rpm)
1387	PMAC Base Volt			•		Rated motor rated voltage in Volt rms
0561	PMAC Winding Resistance			•		The motor's resistance, line to line at 25 °C.
0562	PMAC Winding Inductance			•		The motor's inductance line to line at maximum current
0563	PMAC Torque Const KT			•		Torque constant (Kt, Nm/A rms).
1808	PMAC Encoder Offset			•		
1809	PMAC Wiring			•		
0565	PMAC Therm Time Const			•		The motor's thermal time constant
0564	PMAC Motor Inertia			•		The motor's inertia
0478	PMAC SVC Start Cur			•		The current level during the startup procedure.

6-6 Setup Wizard

PNO	Parameter	Validity				Comment
		IM VHz	IM VECT	PMAC	AFE	
0479	PMAC SVC Start Speed			•		The speed setpoint at which the speed control is switched from an open loop mode to a closed loop mode during the startup procedure
0464	100% Speed in RPM	•	•	•		This is the speed in rpm at which the motor will turn when given a speed demand of 100%.
0486	Acceleration Time	•	•	•		The time that the inverter will take to ramp the setpoint from 0.00% to 100.00% when Ramp Type is LINEAR.
0487	Deceleration Time	•	•	•		The time that the inverter will take to ramp the setpoint from 100.00% to 0.00% when Ramp Type is LINEAR.
1257	Seq Stop Method VHz	•				Selects stopping mode that the controller will use once the run command has been removed when in Volts/Hertz control mode,
0484	Seq Stop Method SVC		•			Selects stopping mode that the controller will use once the run command has been removed when in Sensorless Vector or Closed Loop Vector control mode.
0422	VHz Shape	•				Selects the Volts to Frequency curve.
0390	Duty Selection	•	•	•		Selects the inverter rating. Affects the ratio of nominal current compared with maximum overload current.
1730	AFE Inductance				•	Total inductance (3% + 5%) in the AFE configuration.
1711	AFE VDC Demand				•	DC Link level demand in voltage control mode.
1693	AFE Current Control				•	Sets AFE in current control mode.
1705	AFE Iq Demand				•	Reactive power current demand.
1704	AFE Id Demand				•	Active power current demand.

Fieldbus Options

This section is only shown if a communications option is fitted.

PNO	Parameter	Comment
0044	Comms Required	This defaults to match the communications option that is fitted. If no option is required select NONE. Selecting a different option will result in a configuration error.

These parameters are shown when the CANopen option is fitted.

PNO	Parameter		Comment
0044	Comms Required	CANOPEN	Refer to CANopen Technical Manual HA501841U001
0212	CANopen Node Address	•	
0213	CANopen Baud Rate	•	
0048	Comms Trip Enable	•	

These parameters are shown when the DeviceNet option is fitted.

PNO	Parameter		Comment
0044	Comms Required	DEVICENET	Refer to DeviceNet Technical Manual HA501840U001

6-7 Setup Wizard

PNO	Parameter		Comment
0219	DeviceNet MAC ID	•	
0220	DeviceNet Baud Rate	•	
0048	Comms Trip Enable	•	

These parameters are shown when the Ethernet IP option is fitted.

PNO	Parameter		Comment
0044	Comms Required	ETHERNET IP	<i>Refer to EtherNet IP Technical Manual HA501842U001</i>
0199	Address Assignment	•	
0200	Fixed IP Address	•	
0201	Fixed Subnet Mask	•	
0202	Fixed Gateway Address	•	
0203	Option Web Enable	•	
0048	Comms Trip Enable	•	

These parameters are shown when the Modbus RTU option is fitted.

PNO	Parameter		Comment
0044	Comms Required	MODBUS RTU	<i>Refer to Modbus RTU Technical Manual HA501839U001</i>
0229	Modbus Device Address	•	
0230	Modbus RTU Baud Rate	•	
0231	Parity And Stop Bits	•	
0232	High Word First RTU	•	
0233	Modbus RTU Timeout	•	
0048	Comms Trip Enable	•	

These parameters are shown when the Profibus DPV1 option is fitted.

PNO	Parameter		Comment
0044	Comms Required	PROFIBUS DPV1	<i>Refer to Profibus DP-V1 Technical Manual HA501837U001</i>
0238	Profibus Node Address	•	
0048	Comms Trip Enable	•	

These parameters are shown when the Profinet IO option is fitted.

PNO	Parameter		Comment
0044	Comms Required	PROFINET IO	<i>Refer to Profinet IO Technical Manual HA501838U001</i>
0199	Address Assignment	•	
0200	Fixed IP Address	•	
0201	Fixed Subnet Mask	•	
0202	Fixed Gateway Address	•	
0203	Option Web Enable	•	
0048	Comms Trip Enable	•	

6-8 Setup Wizard

On-board Ethernet

Configuration of the on board Ethernet.

PNO	Parameter	Comment
	Setup Base Ethernet?	Select TRUE to configure the on board Ethernet port. Select FALSE to skip this section
0929	DHCP	
0930	Auto IP	
0933	User IP Address	Only visible if DHCP and Auto IP are both FALSE.
0934	User Subnet Mask	Only visible if DHCP and Auto IP are both FALSE.
0935	User Gateway Address	Only visible if DHCP and Auto IP are both FALSE.
	Setup Base Modbus?	Select TRUE to configure the on board Ethernet port to also act as a Modbus IP client. Select FALSE to skip the following parameters
0939	Maximum Connections	Sets the maximum number of Modbus clients allowed. If set to zero, then no connections will be allowed.
0942	Modbus Trip Enable	Set TRUE to enable the Modbus Trip. The parameter Modbus Timeout must be set to a value other than zero
0940	High Word First	If set to TRUE, the most significant word of a 32-bit parameter will be mapped to the first register, and the least significant word to the next register.
0941	Modbus Timeout	Sets the process active timeout
	Setup Base Ethernet IP?	
3128	EtherNet IP Enable	Enables EtherNet/IP
3129	EtherNet IP Trip	Trip method for the built-in EtherNet/IP
	Setup Base PROFINET?	
3132	PROFINET Enable	Enables the built-in PROFINET IO
3133	PROFINET Trip	Enables the trip for the built-in PROFINET IO

Autotune Parameters

Autotune enable and autotune mode. To run the autotune process, complete the wizard then run the inverter.

PNO	Parameter	Comment
0255	Autotune Enable	Select TRUE to enable a motor autotune next time the motor is started. (Only visible for induction motor sensorless and feedback vector control mode). Refer to Appendix C Parameter Reference for more details.

Finalising Setup

Once the Setup Wizard has been run to completion the feature is automatically disabled. Re-starting the inverter will not cause the Setup Wizard to be run again. (If it is desired to re-run the Setup Wizard, this can be achieved as detailed above in "Starting the Setup Wizard").

6-9 Setup Wizard

Set Up PMAC Motor Control - Sensorless

Minimum steps (and list of parameters) for setting a PMAC motor control in Sensorless mode are given below :

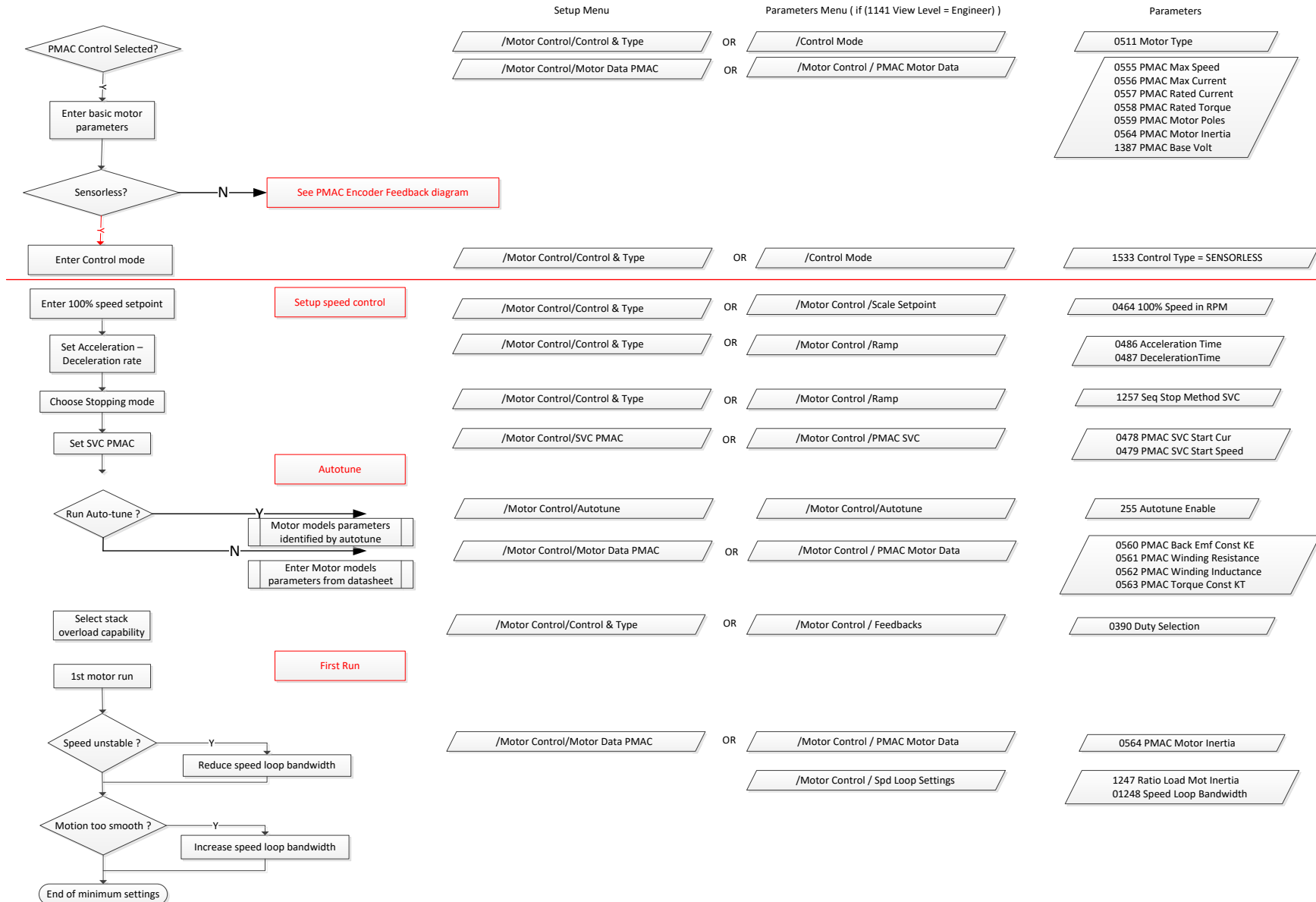

6-10 Setup Wizard

Set Up PMAC Motor Control – Encoder Feedback

Minimum steps (and list of parameters) for setting a PMAC motor control in Closed Loop mode are given below :

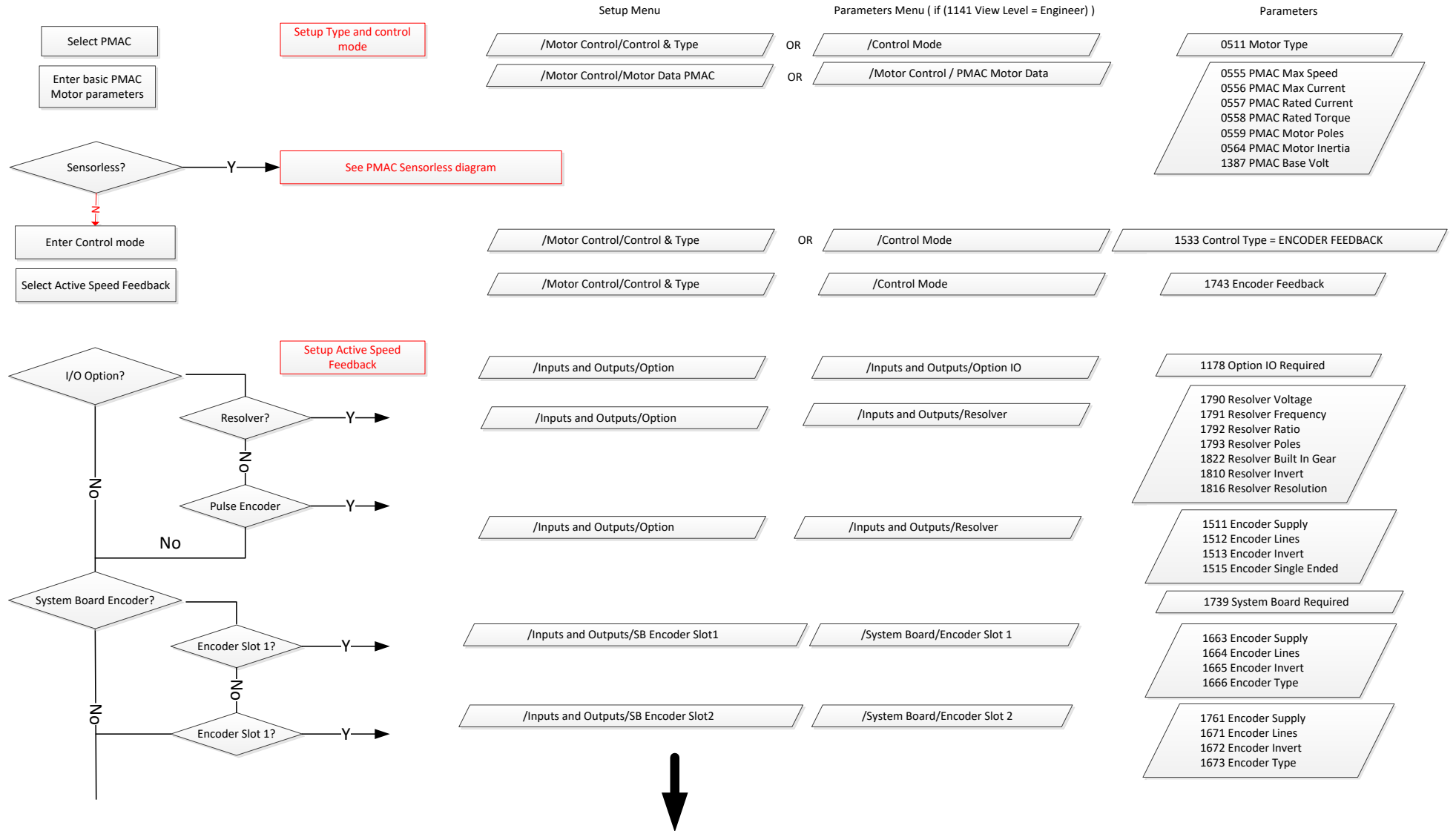

6-11 Setup Wizard

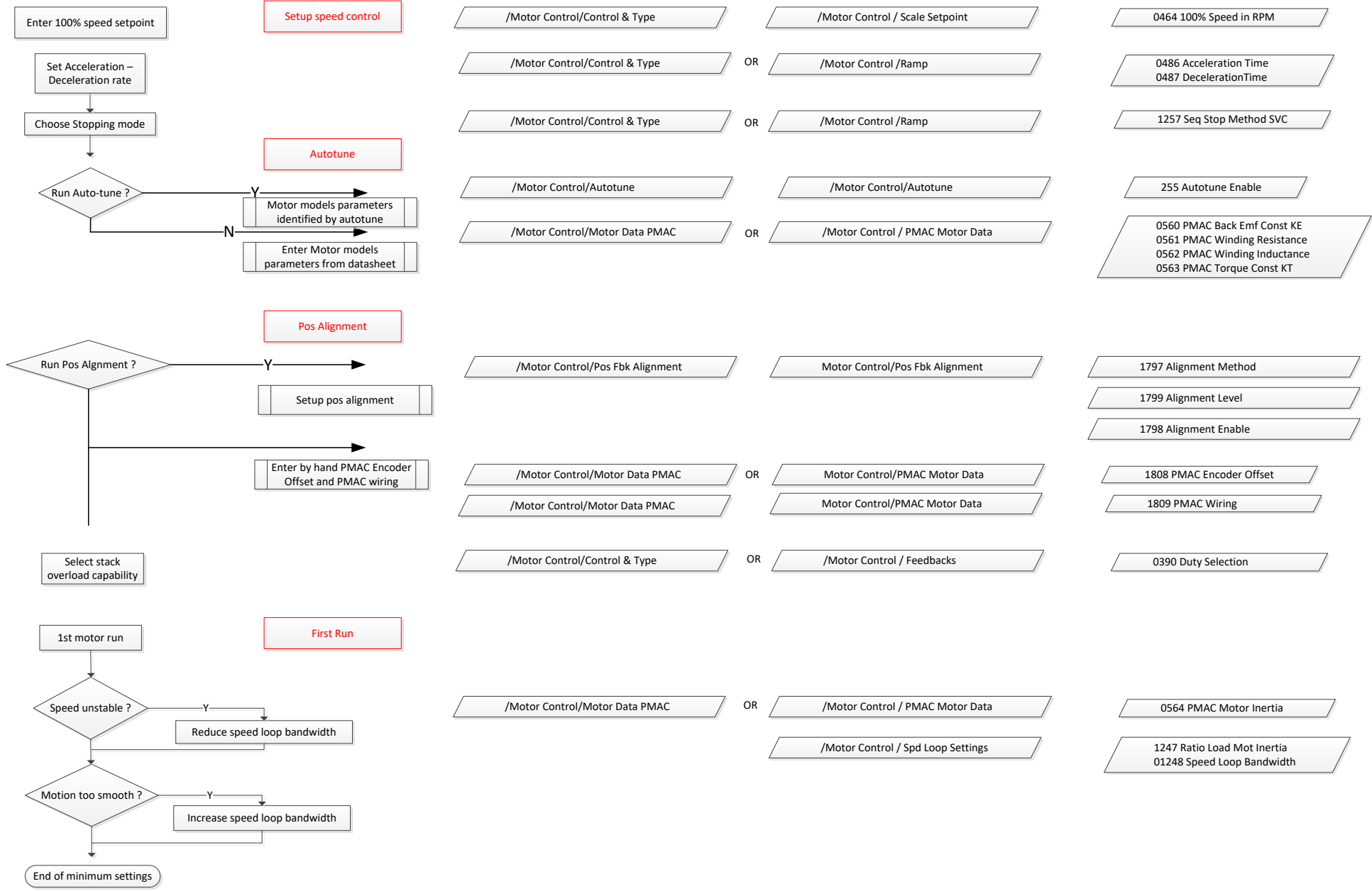

6-12 Setup Wizard

Set Up PMAC Motor Control – Pos Alignment after Power-up

Vector Control of a PMAC motor needs to know the relative position between the rotor and the stator.

Pos Alignment sequence allows to synchronise encoder position to Motor Back EMF.

This feature is used to automatically calculate any offset between the encoder absolute position and the motor back EMF, as well as selecting the correct wiring of the motor (U, V, W sequence) with the encoder position.

The feature needs to be run after each power cycle with a PMAC motor associated to a non absolute encoder type (pulse encoder)

The feature is run on a motor free of rotation, no load attached to the motor shaft.

Depending of the Alignment Method selected, the motor is moving during the sequence.

Below is a simple example on how to force the system to run a Pos Alignment sequence on the first start after power_up :

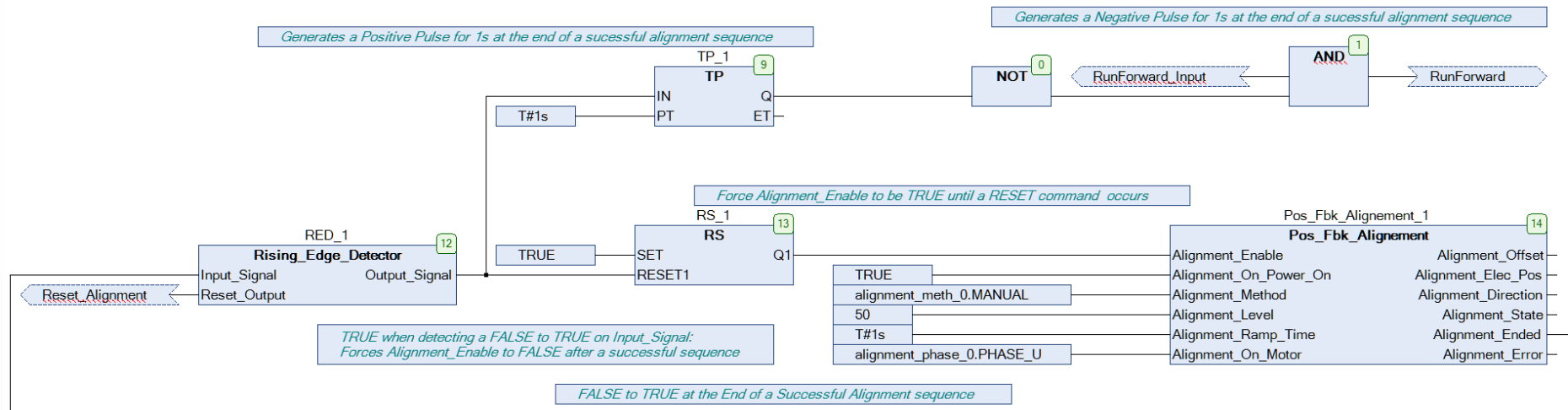

Alignment Method is set to Manual (It could have been set to AUTOMATIC).

Alignment Enable is TRUE from Start-up.

The first start command will run the Pos Alignment sequence.

A running and successfully sequence resets Alignment_Enable to FALSE.

A 1s negative pulse is generated at the end of the sequence. This information can be used to toggle any command to start the system.

6-13 Setup Wizard

Parker Drive Quicktool (PDQ) PC Software

Installation

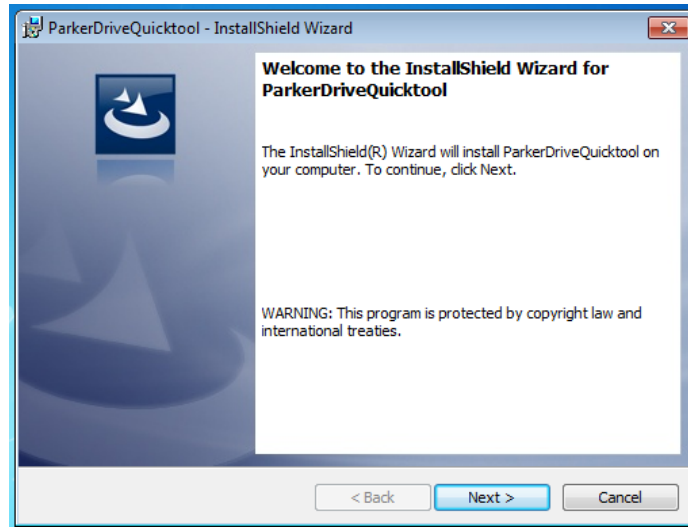

Launch the installer, setup.exe, from the latest version from www.parker.com/ssd/pdq

6-14 Setup Wizard

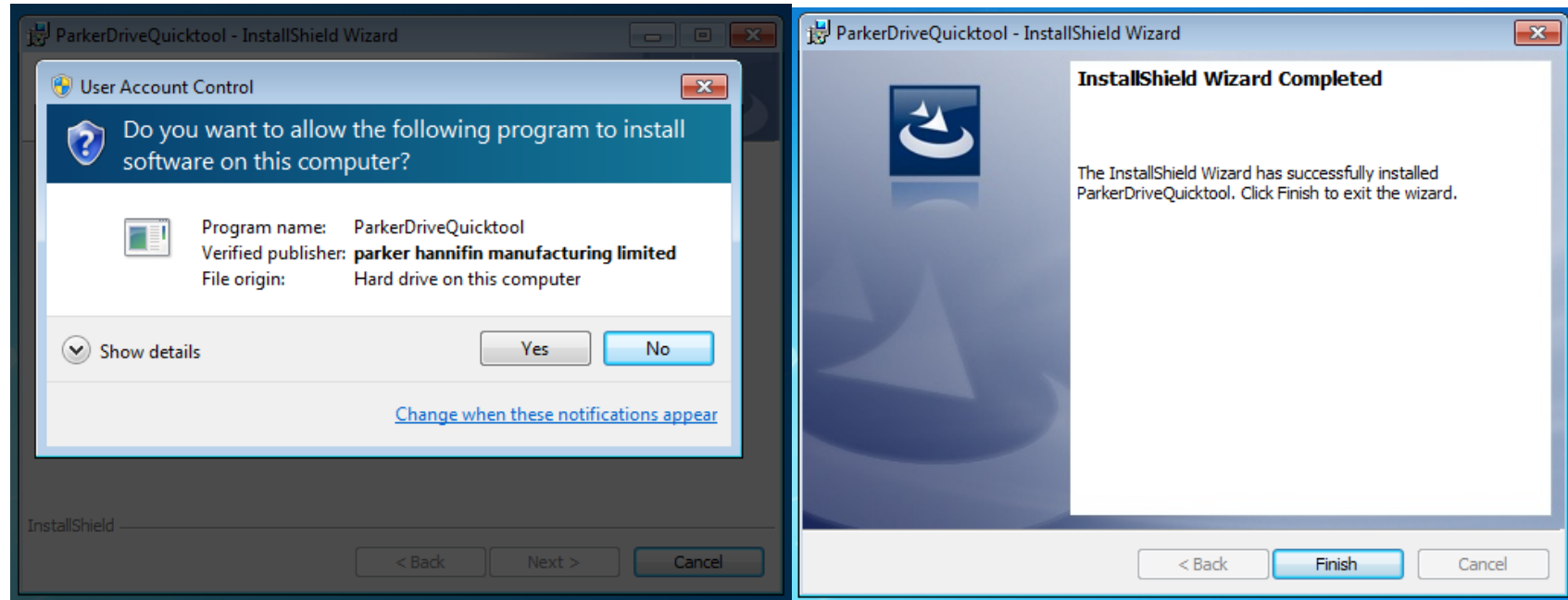

Figure 9-1 InstallShield

Follow the steps of the InstallShield Wizard.

6-15 Setup Wizard

Starting the Wizard

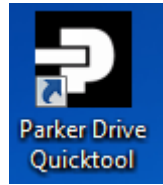

Figure 9-2 Desktop shortcut

Once the InstallShield completes, run the PDQ from the “Start” menu as shown or from the desktop shortcut as shown in

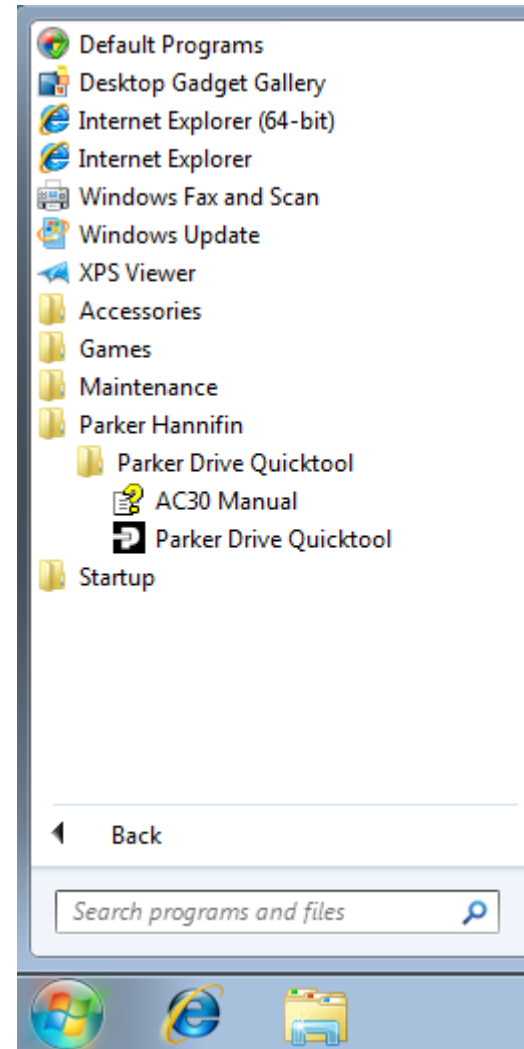

Figure 9-3 Start the Wizard

6-16 Setup Wizard

Task selection

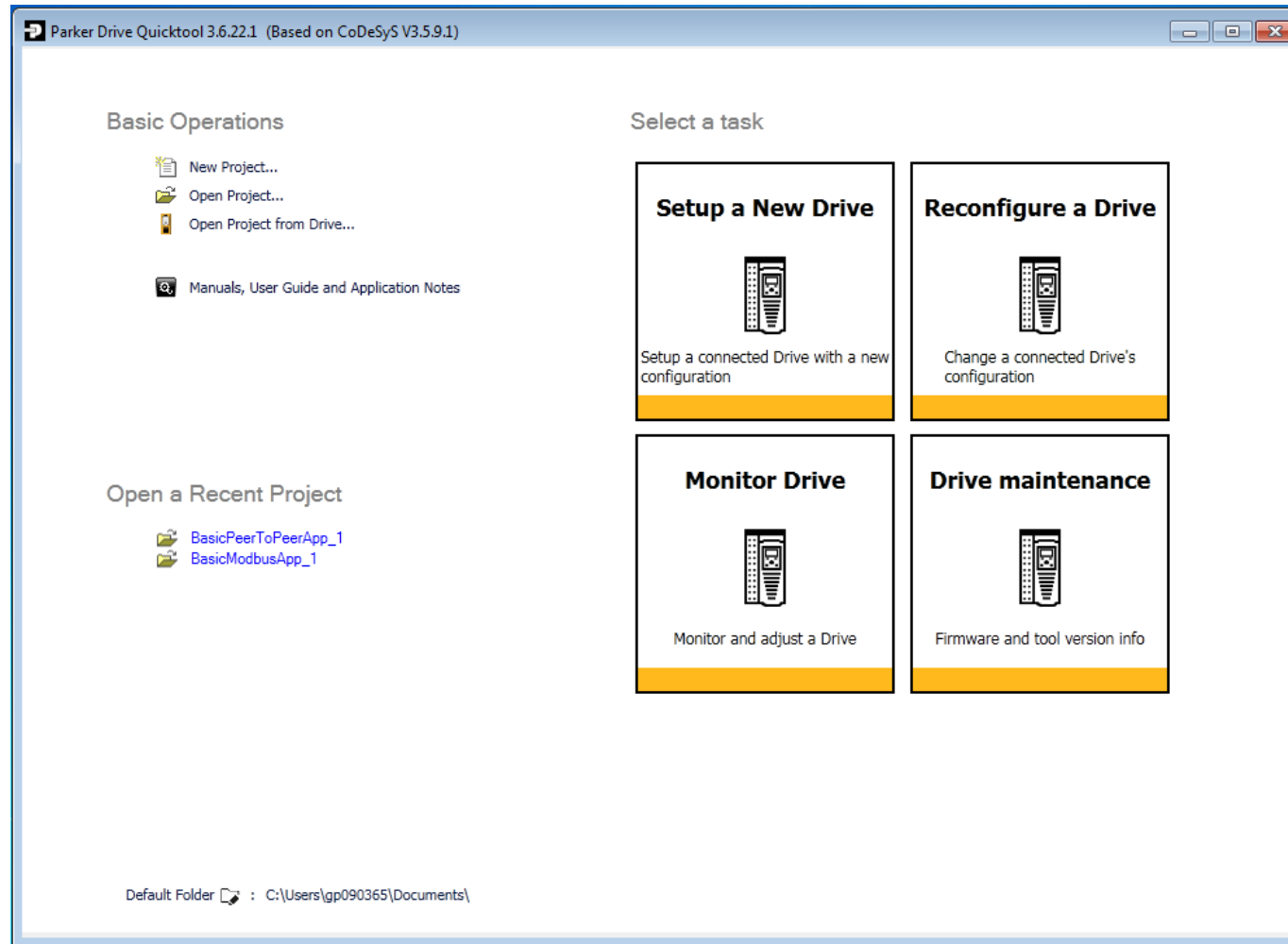

Figure 9-4 Task selection

The start page of the PDQ allows you to create and open projects or select a Wizard task for a connected drive

Note: For Wizard tasks no data or settings will be changed in the Drive until the “Commission” page is reached and download is confirmed by the Engineer. For offline projects a Login button is provided to go online to a connected Drive and make changes.

6-17 Setup Wizard

All the Wizard Tasks use a similar sequence of pages to find and program a Drive. The following page shows the Setup a New Drive wizard and the Find a Drive page

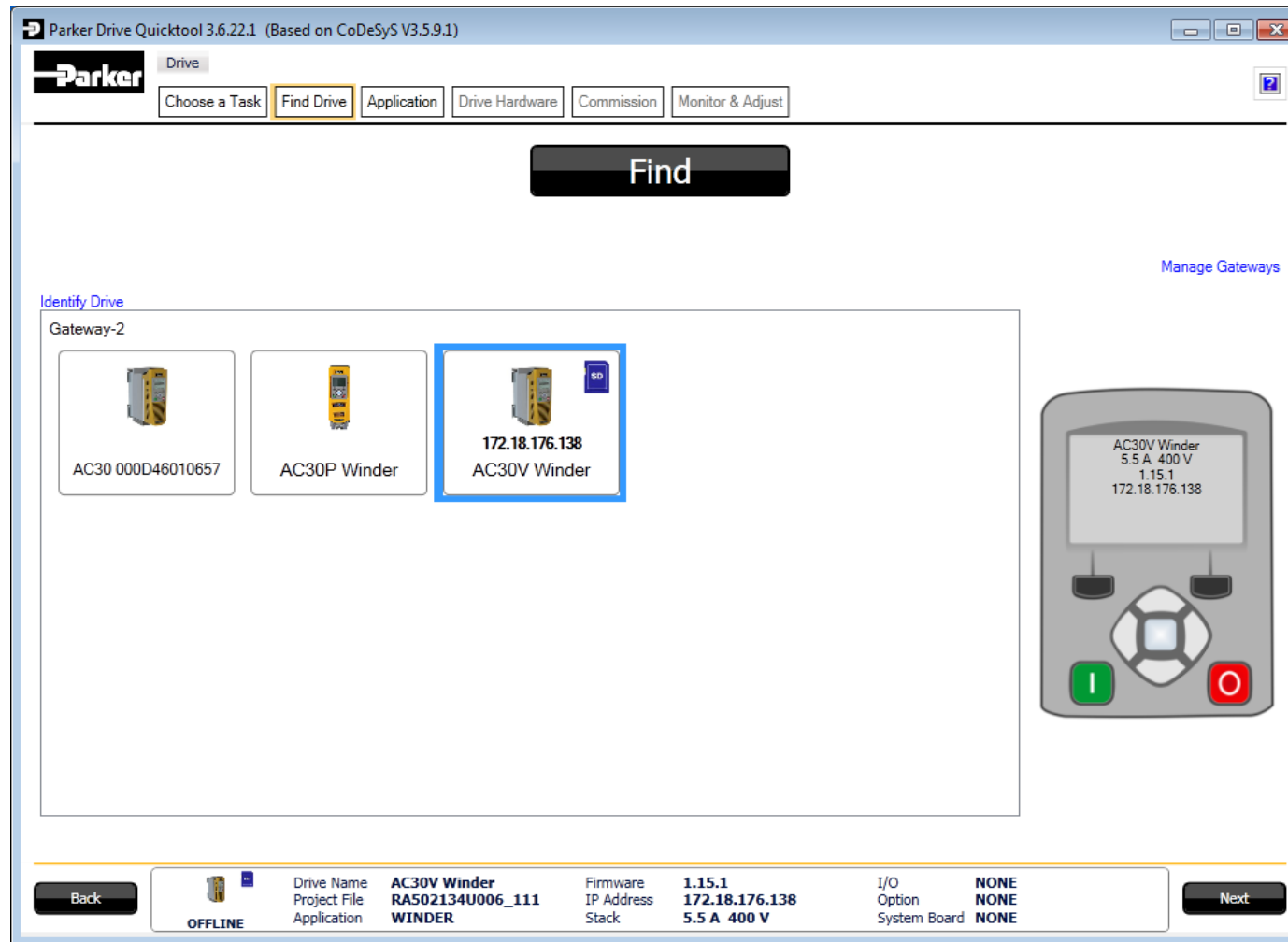

Figure 9-5 Automatic Drive detection

The wizard will automatically detect all the inverters that are visible to the PC via its Ethernet connections. This normally takes 10 seconds, during which time the user interface will go grey and will not respond to you. Once the inverter detection is complete, find your inverter in the list and click on it with the mouse. Information about the selected Drive will be displayed in the status area at the bottom of the screen. Ensure you have selected the correct Drive before continuing. If Drive Brake Switch is not fitted it will be indicated by the symbol as shown in Figure 9-5.

6-18 Setup Wizard

Note: The selected drive's name will match that shown on the GKP home screen.

Click on the "Next" button to begin Commissioning this Drive.

Troubleshooting Drive Detection

Problem	Possible cause	Solution
Drive not found	Drive not connected to the same physical Ethernet network as the PC	Connect Drive and PC to the same network or directly to each other
Drive found but no information displayed	Another person has their PC connected to the Drive	Disconnect the other PC

6-19 Setup Wizard

Application Macro

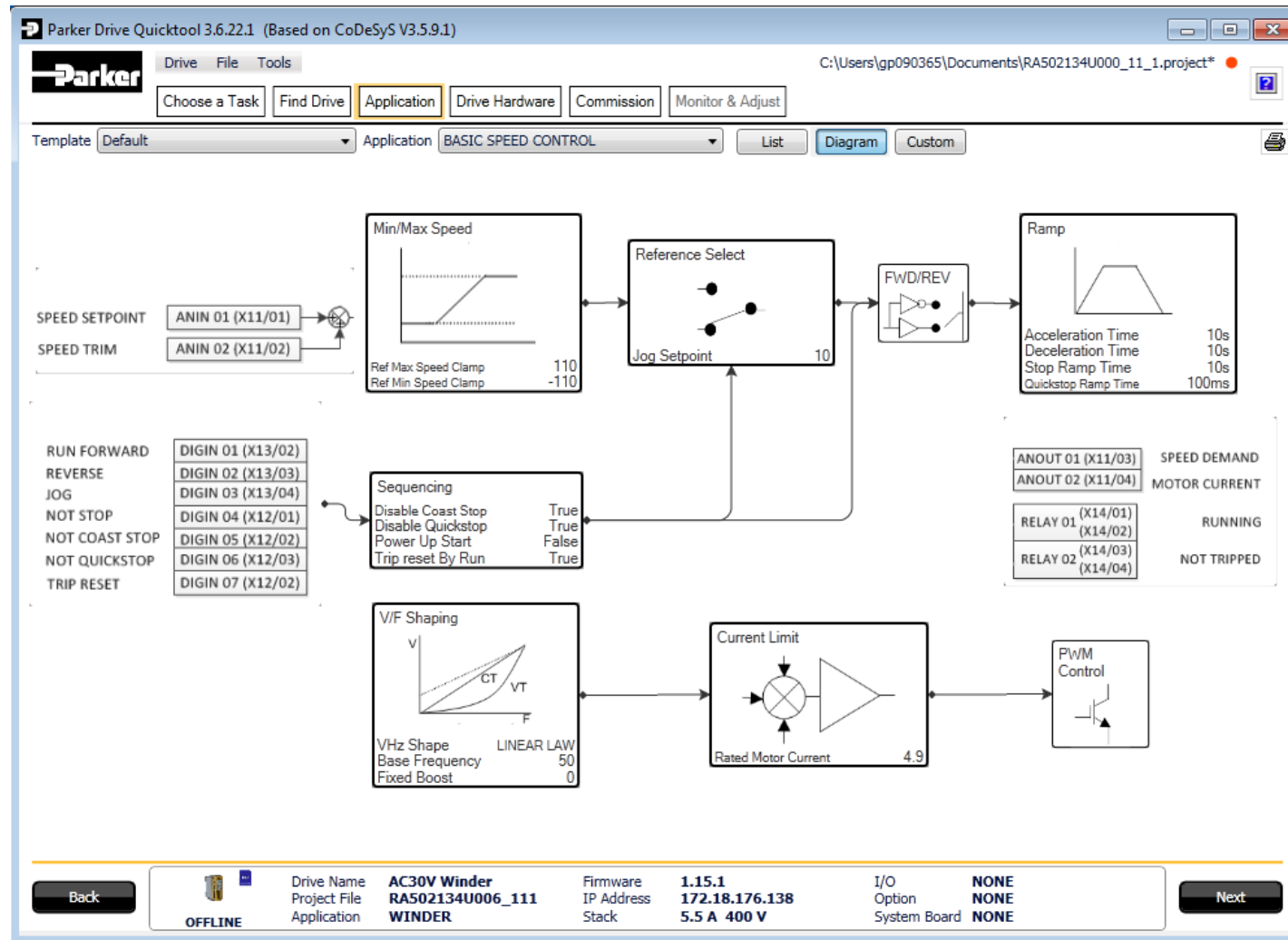

Figure 9-6 Macro selection

Select the desired Application Macro from the drop down list. Adjust any parameters that are needed for your specific application. To make changes to the application logic choose the Custom button.

6-20 Setup Wizard

Drive Hardware

Parker Drive Quicktool 3.6.22.1 (Based on CoDeSyS V3.5.9.1)

Drive File Tools

C:\Users\gp090365\Documents\RA502134U000_11_1.project*

Choose a Task Find Drive Application Drive Hardware Commission Monitor & Adjust

Motor Setup Motor Control Strategy I/O Communications

Motor Type: INDUCTION MOTOR Nominal Supply: 50 Hz Stack Fitted: 5.5 A 400 V Stack Required: 5.5 A 400 V

Motor Data		Basic Control Parameters	
0464	100% Speed in RPM	1500	RPM
0455	Rated Motor Current	4.9	A
0456	Base Voltage	400	V
0457	Base Frequency	50	Hz
0458	Motor Poles	4	
0459	Nameplate Speed	1450	RPM
0460	Motor Power	1.5	kW
0461	Power Factor	0.78	
0464	100% Speed in RPM	1500	RPM
0486	Acceleration Time	10	s
0487	Deceleration Time	10	s
0484	Seq Stop Method VHz	RAMP	
0422	VHz Shape	LINEAR LAW	
0390	Duty Selection	NORMAL DUTY	
0371	Terminal Voltage Mode	NONE	

Motor Database

Back OFFLINE Drive Name AC30V Winder Project File RA502134U006_111 Application WINDER Firmware 1.15.1 IP Address 172.18.176.138 Stack 5.5 A 400 V I/O Option NONE System Board NONE Next

On the Drive Hardware page there are 4 tabs for Motor setup, Motor Control Strategy, IO setup and Communication setup.

6-21 Setup Wizard

Motor Setup

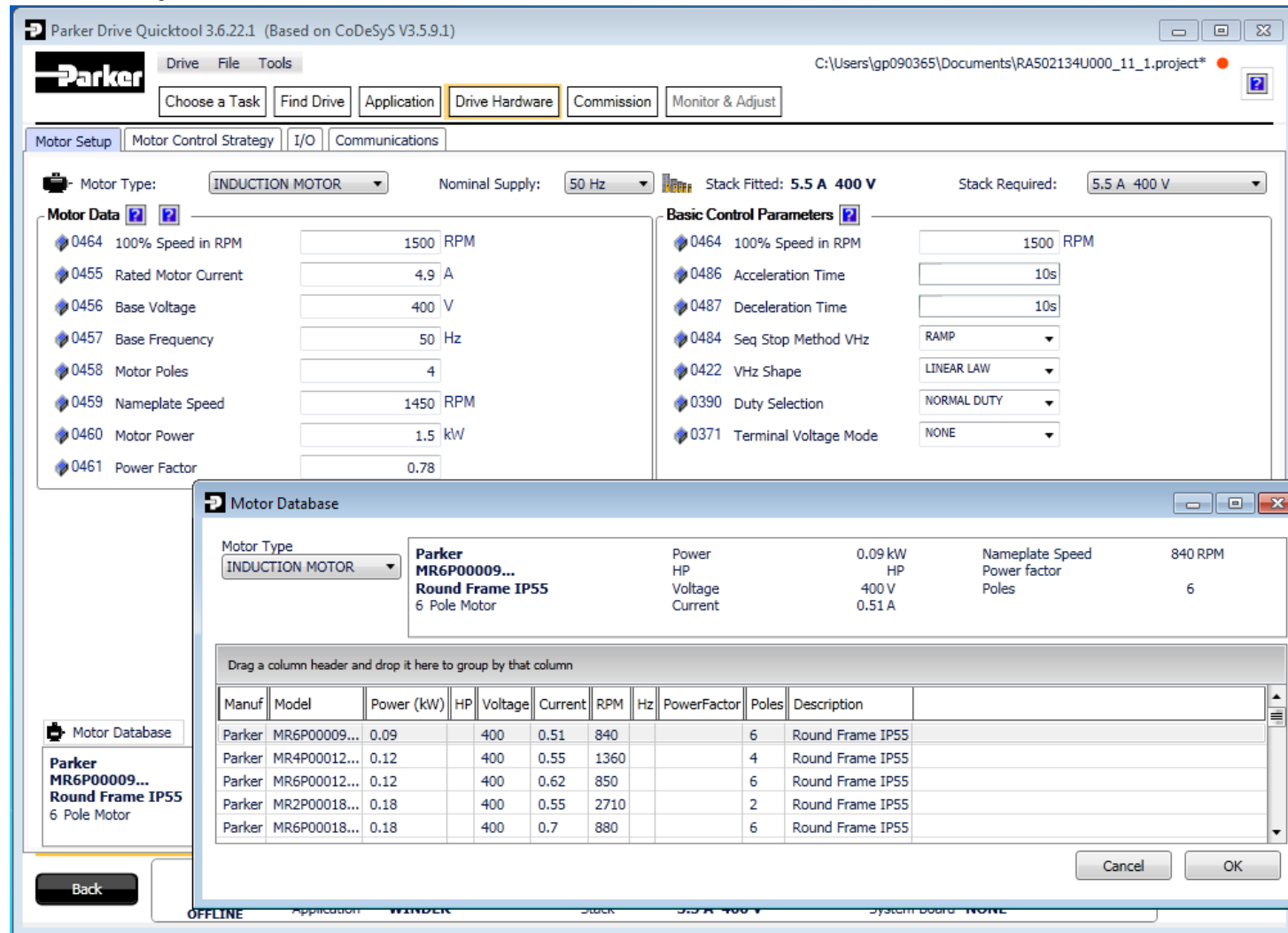

Figure 9-7 Motor selection from database

The Motor Setup tab allows the engineer to define the motor parameters or use the built in motor database to search and select known motor data. Other parameters such as acceleration and deceleration can also be entered here.

6-22 Setup Wizard

Motor Control Strategy

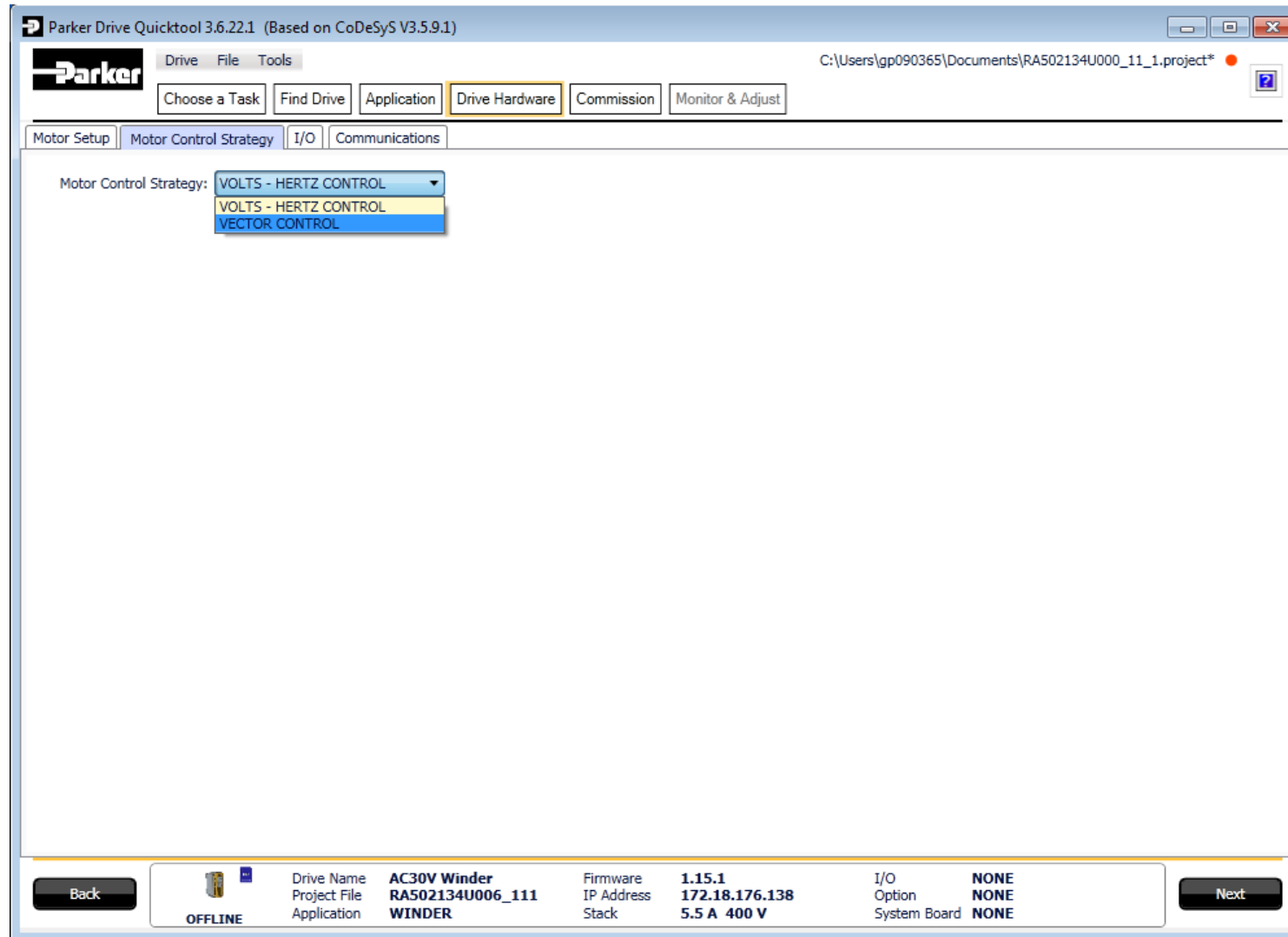

Figure 9-8 Motor Control Strategy

The “Motor Control Strategy” tab allows configuration of the Drive control. The figure above shows a simple V/Hz control strategy but when Vector Control is selected additional parameters are shown for the user to select and configure.

6-23 Setup Wizard

I/O

On this tab the I/O can be changed. If an I/O option card is fitted it can be configured in the "I/O Option" drop down.

The screenshot shows the Parker Drive Quicktool 3.6.22.1 software interface. The title bar indicates it is based on CoDeSyS V3.5.9.1. The main window has a menu bar (Drive, File, Tools) and a toolbar with buttons for 'Choose a Task', 'Find Drive', 'Application', 'Drive Hardware' (highlighted), 'Commission', and 'Monitor & Adjust'. Below the toolbar are tabs for 'Motor Setup', 'Motor Control Strategy', 'I/O' (selected), and 'Communications'. The 'I/O' tab contains two sections: 'Base IO' and 'IO Option'. The 'Base IO' section lists various parameters for Anin 01 and Anin 02, including Type, Offset, Scale, and ABS, with corresponding input fields and dropdown menus. The 'IO Option' section shows 'FITTED: NONE'. At the bottom, there is a status bar with 'Back' and 'Next' buttons, an 'OFFLINE' indicator, and a summary table of system information.

Parameter	Value
0001 Anin 01 Type	-10..10 V
0957 Anin 01 Offset	0 %
0958 Anin 01 Scale	1
0002 Anin 02 Type	-10..10 V
0959 Anin 02 Offset	0 %
0960 Anin 02 Scale	1
0003 Anout 01 Type	-10..10 V
0686 Anout 01 Scale	1
1108 Anout 01 Offset	0 %
1441 Anout 01 ABS	<input type="checkbox"/>
0004 Anout 02 Type	0..10 V
1460 Anout 02 Scale	1
1467 Anout 02 Offset	0 %
1468 Anout 02 ABS	<input type="checkbox"/>

Property	Value
Drive Name	AC30V Winder
Project File	RA502134U006_111
Application	WINDER
Firmware	1.15.1
IP Address	172.18.176.138
Stack	5.5 A 400 V
I/O Option	NONE
System Board	NONE

6-24 Setup Wizard

Communications

On this tab the Communication to and from the Drive can be configured.

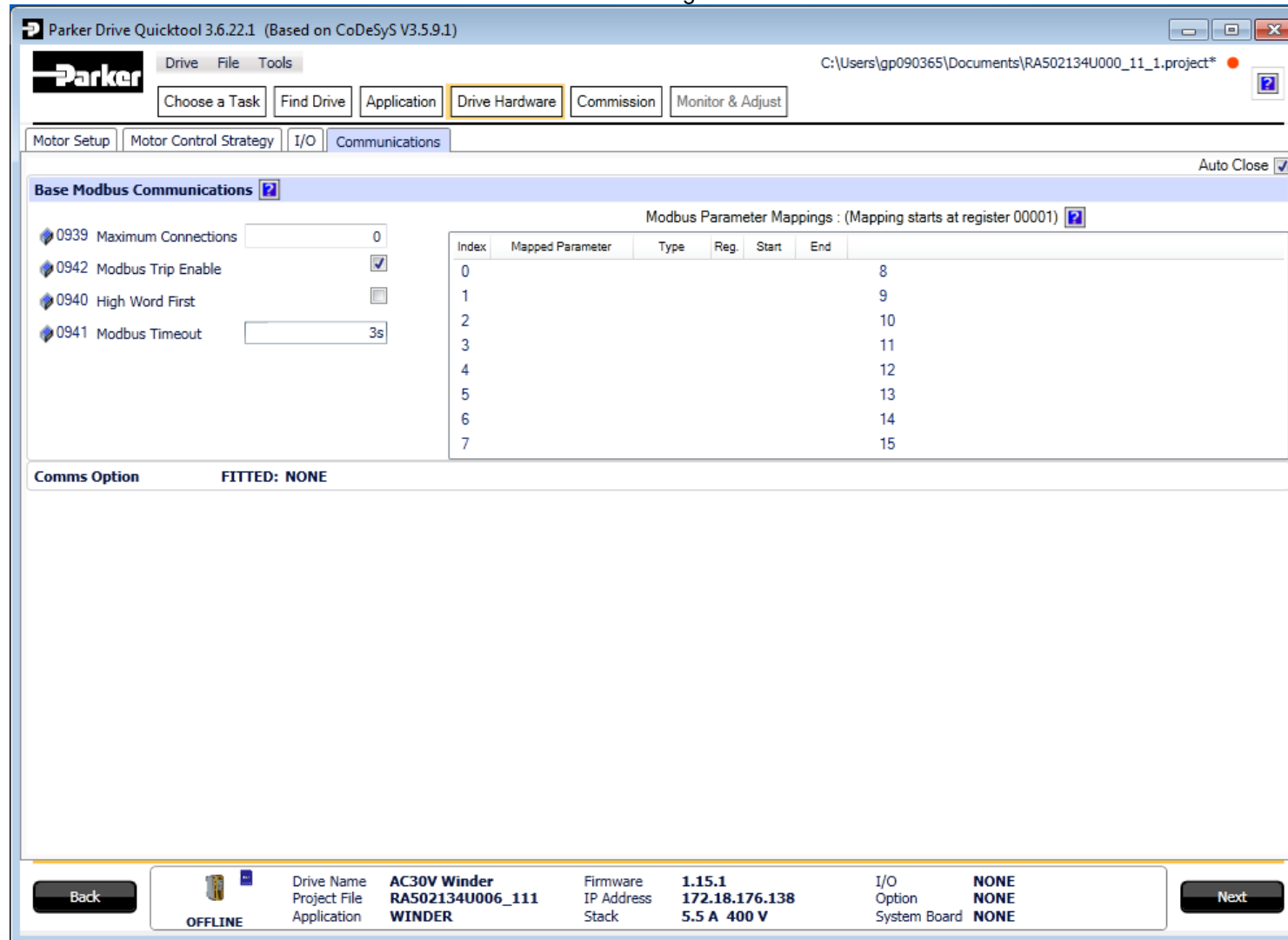

Figure 9-9 Drive Communications setup

If required, the built in Modbus can be setup from, the “Base Modbus Communication” selection.

If an optional Fieldbus is fitted, it can be configured from the “Comms Option” selection.

6-25 Setup Wizard

Commission the Drive

Parker Drive Quicktool 3.6.22.1 (Based on CoDeSyS V3.5.9.1)

Drive File Tools

C:\Users\lgp090365\Documents\RA502134U000_11_1.project*

Choose a Task Find Drive Application Drive Hardware **Commission** Monitor & Adjust

Project File: RA502134U000_11_1 **Program Drive**

Application: BASIC SPEED CONTROL

Drive Name: AC30V Winder

Drive Display Language: ENGLISH

GKP View Level: TECHNICIAN Web Access: LIMITED

Back OFFLINE Drive Name: AC30V Winder Project File: RA502134U006_111 Application: WINDER Firmware: 1.15.1 IP Address: 172.18.176.138 Stack: 5.5 A 400 V I/O Option: NONE System Board: NONE Next

Figure 9-10 Programming the Drive

The “Commission” page is used to commission the Drive with the Selected macro and motor settings chosen during the Wizard session. There are two steps that are performed to finalise the Commissioning of the Drive.

1. Enter the Project File name and the Drive’s name in the left of the screen.
2. “Program Drive”. This step writes your settings to the Drive and overwrites any existing configuration in the Drive.

After these steps, the Drive is ready to use.

6-26 Setup Wizard

Monitor the Drive

Parker Drive Quicktool 3.6.22.1 (Based on CoDeSyS V3.5.9.1)

Drive File Tools

C:\Users\gp090365\Documents\RA502134U000_11_1.project*

Choose a Task Find Drive Application Drive Hardware Commission Monitor & Adjust

Parameter Menu Parameter Browser

Parameter Menu Motor and Drive

Tag	Name	Value	Current Value	Chart
0393	Actual Speed RPM		0.00 RPM	
0392	DC Link Voltage		0 V	
0394	Actual Speed rps		0.00 rev/s	
0395	Actual Speed Percent		0.00 %	
0396	DC Link Volt Filtered		0 V	
0399	Actual Torque		0.0 %	
0400	Actual Field Current		0.0 %	
0401	Motor Current Percent		0.0 %	
0402	Motor Current		0.0 A	
0405	Motor Terminal Volts		0 V	
0420	Actual Pos Torque Lim		150.0 %	
0421	Actual Neg Torque Lim		-150.0 %	
0407	Heatsink Temperature		20.0 °C	
0406	CM Temperature		20.0 °C	

Chart Channel 1 Enable Use Left Axis Channel 2 Enable Use Left Axis

Back OPERATIONAL Drive Name **AC30V Winder** Firmware **1.15.1** I/O **NONE**
Project File **RA502134U000_11_1** IP Address **172.18.176.138** Option **NONE**
Application **BASIC SPEED CONTROL** Stack **5.5 A 400 V** System Board **NONE** Next

Figure 9-11 Monitor the Drive and fine tune

6-27 Setup Wizard

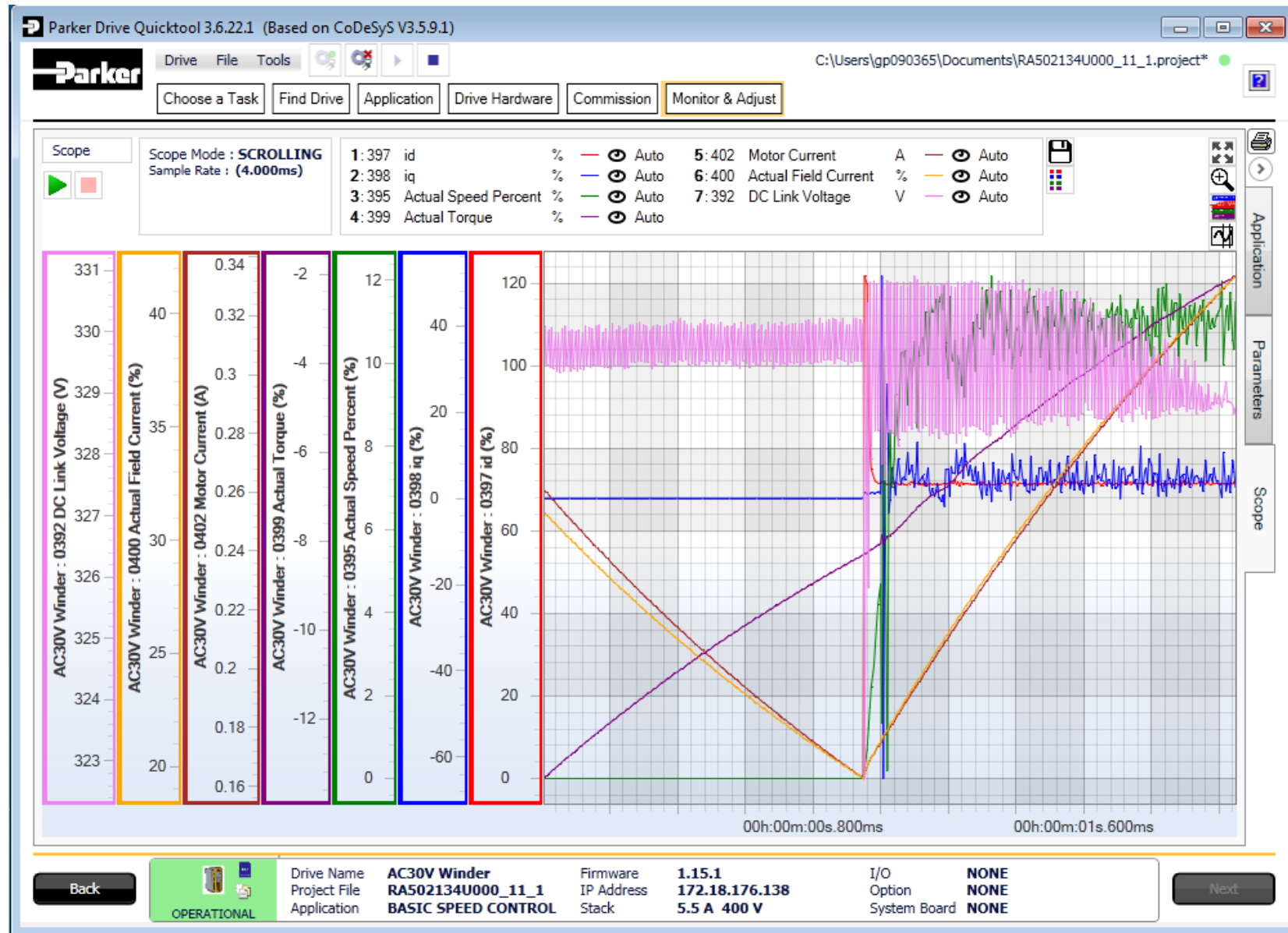

Figure 9-16 Scoping Drive Parameters

6-28 Setup Wizard

Chapter 7: Trips & Fault Finding

What Happens when a Trip Occurs

When a trip occurs, the drive's power stage is immediately disabled causing the motor and load to coast to a stop. The trip is latched until action is taken to reset it. This ensures that trips due to transient conditions are captured and the drive is disabled, even when the original cause of the trip is no longer present.

Keypad Indications

If a trip condition is detected the activated alarm is displayed on the GKP display.

Resetting a Trip Condition

All trips must be reset before the drive can be re-enabled. A trip can only be reset once the trip condition is no longer active, i.e. a trip due to a heatsink over-temperature will not reset until the temperature is below the trip level.

You can reset the trip as follows:

1. Press the  (STOP) key to reset the trip and clear the alarm from the display.
2. In remote terminal sequencing mode, create a 0 to 1 transition on the RESET TRIP bit, (bit 7), in the App Control Word parameter.
3. In remote communications sequencing mode, create a 0 to 1 transition on the RESET TRIP bit, (bit 7), in the Comms Control Word parameter.

7-2 Trips & Fault Finding

Using the Keypad to Manage Trips

Trip Messages

If the drive trips, then the display immediately shows a message indicating the reason for the trip. The possible trip messages are given in the table below.

ID	Trip Name	Possible Reason for Trip	Criteria for Warning
1	OVER VOLTAGE	<p><i>The drive internal dc link voltage is too high:</i></p> <ul style="list-style-type: none"> The supply voltage is too high Trying to decelerate a large inertia load too quickly; DECEL TIME time too short The brake resistor is open circuit <p>To help prevent this trip, enable the DC Link Volts Limit feature</p>	<p><i>Internal dc link voltage has reached midway between the over voltage trip level and the dynamic braking resistor control voltage.</i></p>
2	UNDER VOLTAGE	<p><i>DC link low trip:</i></p> <ul style="list-style-type: none"> Supply is too low/power down 	<p><i>Internal dc link voltage has reached midway between the lowest expected instantaneous voltage and the under voltage trip level.</i></p>
3	OVER CURRENT	<p><i>The motor current being drawn from the drive is too high:</i></p> <ul style="list-style-type: none"> Trying to accelerate a large inertia load too quickly; ACCEL TIME time too short Trying to decelerate a large inertia load too quickly; DECEL TIME time too short Application of shock load to motor Short circuit between motor phases Short circuit between motor phase and earth Motor output cables too long or too many parallel motors connected to the drive FIXED BOOST level set too high 	<p><i>The over current trip makes up of a multiple-attempt strategy. The warning is triggered if two or more consecutive overcurrent events are encountered (whereas five consecutive events are required for a Trip to occur).</i></p>
4	STACK FAULT	<p><i>Stack self protection</i></p> <ul style="list-style-type: none"> Instantaneous overcurrent detected by the power stack. Refer to OVERCURRENT in this table. Instantaneous over voltage event. Refer to OVER VOLTAGE in this table 	<p><i>Not applicable.</i></p>
5	STACK OVER CURRENT	<p><i>The motor current exceeded the capabilities of the power stack.</i></p> <ul style="list-style-type: none"> Instantaneous overcurrent detected by the power stack. Refer to OVERCURRENT in this table. 	<p><i>Not applicable.</i></p>
6	CURRENT LIMIT	<p>V/Hz mode only: If the current exceeds 200% of stack rated current for a period of 1 second, the drive will trip. This is caused by shock loads</p>	<p><i>Not applicable.</i></p>

Trips & Fault Finding 7-3

ID	Trip Name	Possible Reason for Trip	Criteria for Warning
7	MOTOR STALL	<p><i>The motor has stalled (not rotating) Drive in current limit >200 seconds:</i></p> <ul style="list-style-type: none"> • Motor loading too great • FIXED BOOST level set too high 	<i>The stall condition has been detected for more than half of the configured Stall Time.</i>
8	INVERSE TIME	<p><i>A prolonged overload condition, exceeding the Inverse Time allowance, has caused the trip:</i></p> <ul style="list-style-type: none"> • Remove the overload condition 	<i>An overload condition has exceeded one half of the Inverse Time allowance.</i>
9	MOTOR I2T	Only for PMAC Motor: A prolonged load condition, exceeding the motor rated current, has caused the trip. The estimated motor load has reached a value of 105%	<i>An overload condition has exceeded one half of the motor Inverse Time allowance.</i>
10	LOW SPEED I	<p><i>The motor is drawing too much current (>100%) at zero output frequency:</i></p> <ul style="list-style-type: none"> • FIXED BOOST level set too high 	<i>Not applicable.</i>
11	HEATSINK OVERTEMP	<p><i>Drive heatsink temperature too high</i></p> <ul style="list-style-type: none"> • The ambient air temperature is too high • Poor ventilation or spacing between drives • Check heatsink fan is rotating 	<i>The drive heatsink has exceeded the warning temperature level (which is approx. 10 °C below the trip temperature).</i>
12	INTERNAL OVERTEMP	<p><i>Processor temperature or ambient temperature within the power stage too high</i></p> <ul style="list-style-type: none"> • The ambient temperature in the drive is too high 	<i>The drive processor temperature has exceeded the warning temperature level (which is approx. 10 °C below the trip temperature).</i>
13	MOTOR OVERTEMP	<p><i>The motor temperature is too high, (required IO Option card)</i></p> <ul style="list-style-type: none"> • Excessive load • Motor voltage rating incorrect • FIXED BOOST level set too high • Prolonged operation of the motor at low speed without forced cooling • Break in motor thermistor connection 	<i>The motor has been over temperature for 7.5 seconds.</i>
14	EXTERNAL TRIP	<p><i>The external (application) trip input is high:</i></p> <ul style="list-style-type: none"> • Refer to the application description to identify the source of the signal 	<i>Not applicable.</i>
15	BRAKE SHORT CCT	<p><i>External dynamic brake resistor has been overloaded:</i></p> <ul style="list-style-type: none"> • The external dynamic brake has developed a short circuit. • Wiring fault 	<i>Not applicable.</i>

7-4 Trips & Fault Finding

ID	Trip Name	Possible Reason for Trip	Criteria for Warning
16	BRAKE RESISTOR	<p><i>External dynamic brake resistor has been overloaded:</i></p> <ul style="list-style-type: none"> Trying to decelerate a large inertia too quickly or too often 	<i>The power calculation for the external resistor has exceeded one half of the Brake Overrating allowance.</i>
17	BRAKE SWITCH	<p><i>Internal dynamic braking switch has been overloaded:</i></p> <ul style="list-style-type: none"> Trying to decelerate a large inertia too quickly or too often 	<i>The power calculation for the internal dynamic braking switch has exceeded one half of the its overrating allowance.</i>
18	LOCAL CONTROL	<p><i>Keypad has been disconnected from drive whilst drive is running in Local Control:</i></p> <ul style="list-style-type: none"> GKP accidentally disconnected from drive 	<i>Not applicable.</i>
19	COMMS BREAK	<p><i>Lost option communications:</i></p> <ul style="list-style-type: none"> A break in option communications has been detected. Refer to option communications manual. 	<i>Not applicable.</i>
20	LINE CONTACTOR	<p><i>DC Link failed to reach the undervoltage trip level within the contactor feedback time.</i></p> <ul style="list-style-type: none"> The Line contactor failed to connect. Missing 3-phase line supply 	<i>Not applicable.</i>
21	PHASE FAIL	<ul style="list-style-type: none"> Indicates a missing input phase, for Frame K, L and M drives. Disable this trip for DC fed units. 	<i>Not applicable.</i>
22	VDC RIPPLE	<p><i>The DC link ripple voltage is too high:</i></p> <ul style="list-style-type: none"> Check for a missing input phase Repetitive start / stop or forward reverse action. 	<i>The dc link ripple has exceeded 75% of the trip level.</i>
23	BASE MODBUS BREAK	<p><i>Lost Base Modbus communications:</i></p> <ul style="list-style-type: none"> A break in the Base Modbus communications has been detected. Refer to "Appendix A Fieldbuses 	<i>Not applicable.</i>
24	24V OVERLOAD	<p><i>24V rail is low</i></p> <ul style="list-style-type: none"> Output overload due to excess current being drawn from the 24v terminal. 	<i>Not applicable.</i>
25	PMAC SPEED ERROR	<p><i>Only for PMAC motor : When using the Start feature in Sensorless Vector Control, the real speed hasn't reached the speed setpoint after 5 seconds to move from open to closed loop control or to move from closed to open loop</i></p>	<i>Not applicable.</i>
26	OVERSPEED	<p><i>Overspeed:</i></p> <ul style="list-style-type: none"> >150% base speed when in Sensorless Vector mode 	<i>Not applicable.</i>

Trips & Fault Finding 7-5

ID	Trip Name	Possible Reason for Trip	Criteria for Warning
27	STO ACTIVE	<p><i>Attempt to run the motor with the Safe Torque Off active</i></p> <ul style="list-style-type: none"> Check the STO wiring. It may be necessary to power the drive off and on to completely clear this event. 	<i>Not applicable.</i>
28	FEEDBACK MISSING	<p><i>The drive has been configured to run in Closed Loop Vector control mode with a Pulse Encoder IO Option, but the IO Option has not been correctly configured.</i></p> <p>The drive has been configured to run in Closed Loop Vector control mode with a System Board and/or a Pulse Encoder IO Option (using one of the 3 possible encoder inputs), but the system board or the IO option has not been declared as required.</p>	<i>Not applicable.</i>
29	INTERNAL FAN FAIL	<p><i>An internal cooling fan has failed. This will reduce the lifetime of the power electronics.</i></p> <ul style="list-style-type: none"> Return the power stack to a Parker Hannifin repair centre. 	<i>Not applicable.</i>
30	CURRENT SENSOR	<p><i>Current feedback phase missing</i></p> <ul style="list-style-type: none"> Check motor phase connections 	<i>Not applicable.</i>
31	POWER LOSS STOP	<i>A Power Loss Ride Through sequence has occurred and either 1650 Pwrl Time Limit has been exceeded or the motor speed has reached a zero speed during the sequence.</i>	<i>Not applicable.</i>
32	SPEED SENSOR FAULT	Not applicable.	Encoder has failed whilst operating in vector control of induction motor. The drive switches to sensorless operation automatically (if this feature is enabled), and provides a warning to the user.
33	A1	<i>Application trip 1. The application trips are controlled by the Application_Trips block in the configuration. The text associated with each trip can be re-defined by the Application_Trips_Text block in the configuration.</i>	<i>Application warning 1.</i>
34	A2	<i>Application trip 2</i>	<i>Application warning 2.</i>
35	A3	<i>Application trip 3</i>	<i>Application warning 3.</i>
36	A4	<i>Application trip 4</i>	<i>Application warning 4.</i>
37	A5	<i>Application trip 5</i>	<i>Application warning 5.</i>
38	A6	<i>Application trip 6</i>	<i>Application warning 6.</i>
39	A7	<i>Application trip 7</i>	<i>Application warning 7.</i>

7-6 Trips & Fault Finding

ID	Trip Name	Possible Reason for Trip	Criteria for Warning
40	A8	Application trip 8	Application warning 8.
41	SPEED ERROR FAULT	Difference between actual motor speed and the speed setpoint is greater than a threshold for a period of time.	Difference between actual motor speed and the speed setpoint has been greater than the trip threshold for more than half the trip delay time.
42	PEER TO PEER OVERRUN	Configuration error on Master and/or Slave(s) side PTP or Peer to Peer are OFF on one drive Destination IP or Destination Port incompatible between Master and Slave(s) Peer to Peer is not useable	Multiple delayed Peer To Peer messages have occurred. This may cause incorrect phase alignment if phase control is being used.
43	PHASE CONFIG	Something is wrong in the phase configuration : one or more of the encoders set up for speed control, master and/or slave are wrongly declared. See Phase Ctrl Config : Error Number for a detailed description of the error (Only applicable if phase control is enabled)	Not applicable.
44	ETHERNET IP BREAK	Lost Base EtherNet IP communications: A break in the Base EtherNet IP communications has been detected. Refer to "Appendix A Fieldbuses".	Not applicable.
45	RESOLVER ERROR	An error has been detected on the resolver signals Error type is available by looking at 1820 Resolver Trip Type	Not applicable
46	PMAC ALIGN ERROR	If 1796 Alignment on Power On has been set to TRUE, the drive should run a successful Pos Alignment sequence, at power up before being run safely. Or Something wrong occurred during the last Pos Alignment sequence. Error type is available by looking at 1807 Alignment error	Not applicable
47	CURRENT IMBALANCE	The motor current on the three output phases is not equal. • Check for Motor earth fault	Not applicable
48	CONFIGURATION	The hardware fitted, (IO Option, Communications Option or Stack Rating), does not match the configuration. • Check PNO1178 Option IO Required, PNO0044 Comms Required and PNO0987 Power Stack Required.	Not applicable
49	APPLICATION	The application is taking longer than 500ms to complete a single execution.	Half the trip time

Trips & Fault Finding 7-7

ID	Trip Name	Possible Reason for Trip	Criteria for Warning
50	AC30A ENCODER	<i>Missing sin and/or cos signals</i>	Not applicable
51	CPU USAGE	<i>Combination of high switching frequency, high network traffic and complicated configuration. Run the application at a slower task rate, reduce the Ethernet load or reduce the switching frequency.</i>	Time based, warning issued at least 0.5s before the trip.

7-8 Trips & Fault Finding

Hexadecimal Representation of Trips

Each trip has a unique, eight-digit hexadecimal number as shown in the tables below. This number is referred to as the trip mask. The trip masks are used in the Enable, Active and Warnings parameters in the Trips module.

ID	Trip Name	Mask	User Disable
1	OVER VOLTAGE	00000001	
2	UNDER VOLTAGE	00000002	
3	OVER CURRENT	00000004	
4	STACK FAULT	00000008	
5	STACK OVER CURRENT	00000010	
6	CURRENT LIMIT	00000020	✓
7	MOTOR STALL	00000040	✓
8	INVERSE TIME	00000080	✓
9	MOTOR I2T	00000100	✓
10	LOW SPEED I	00000200	✓
11	HEATSINK OVERTEMP	00000400	
12	AMBIENT OVERTEMP	00000800	✓
13	MOTOR OVERTEMP	00001000	✓
14	EXTERNAL TRIP	00002000	✓
15	BRAKE SHORT CCT	00004000	✓
16	BRAKE RESISTOR	00008000	✓
17	BRAKE SWITCH	00010000	✓
18	LOCAL CONTROL	00020000	✓
19	COMMS BREAK	00040000	✓
20	LINE CONTACTOR	00080000	✓
21	PHASE FAIL	00100000	✓
22	VDC RIPPLE	00200000	✓
23	BASE MODBUS BREAK	00400000	✓
24	24V OVERLOAD	00800000	✓
25	PMAC SPEED ERROR	01000000	✓
26	OVERSPEED	02000000	✓

ID	Trip Name	Mask	User Disable
27	SAFE TORQUE OFF	04000000	
28	FEEDBACK MISSING	08000000	
31	POWER LOSS STOP	40000000	✓
32	SPEED SENSOR FAULT	80000000	✓
33	A1	00000001*	✓
34	A2	00000002*	✓
35	A3	00000004*	✓
36	A4	00000008*	✓
37	A5	00000010*	✓
38	A6	00000020*	✓
39	A7	00000040*	✓
40	A8	00000080*	✓
41	SPEED ERROR FAULT	00000100*	✓
42	PEER TO PEER OVERRUN	00000200*	✓
43	PHASE CONFIG	00000400*	✓
44	ETHERNET IP BREAK	00000800*	✓
45	RESOLVER ERROR	00001000*	
46	PMAC ALIGN ERROR	00002000*	
47	STACK IMBALANCE	00004000*	✓
48	CONFIGURATION	00008000*	
49	APPLICATION	00010000*	
50	AC30A ENCODER	00020000*	
51	CPU Usage	00040000*	

* These masks apply to parameter words "33 – 64"

Runtime Alerts

A Runtime Alert is a fault that indicates a permanent hardware error. The Runtime Alert display is of the form

```

  RUNTIME ALERT
  CODE  00000000  xx
  
```

CODE is a number in the range 0 to 65000. The following value is used to provide additional information to assist Parker Hannifin Technical Support personnel.

CODE	ERROR	Possible Reason for Error
1 to 255	Internal exception	<ul style="list-style-type: none"> VCM not secured to power stack Option not secured correctly to VCM control card Earth bonding failure. Fault during firmware upgrade
12	Memory access	<ul style="list-style-type: none"> Attempt to read or write to protected memory. Most likely this will be due to a configuration error. Press OK several times until the drive resets correctly, then replace the configuration using PDQ. Record the error message and contact Technical Support
1001 to 1003	Processor overload	<ul style="list-style-type: none"> Select a lower switching frequency, (Parameters::Motor Control::Pattern Generator::Stack Frequency) Record the error message and contact Technical Support
1006	Memory overflow	<ul style="list-style-type: none"> Reduce the complexity of the application Reduce the number of parameters being accessed via the on board Modbus TCP protocol Reduce the number of parameters being accessed by the fieldbus communications option.
1007	Uninitialized pointer	<ul style="list-style-type: none"> Record the error message and contact Technical Support
1010, 1101 to 1113	Initialization error	<ul style="list-style-type: none"> Record the error message and contact Technical Support
1200 to 1299	Communications option error	<ul style="list-style-type: none"> Ensure the communications option is correctly fitted Update the firmware in the inverter. Replace the communications option
1300	Ethernet fault	<ul style="list-style-type: none"> Record the error message and contact Technical Support

7-10 Trips & Fault Finding

CODE	ERROR	Possible Reason for Error
1301	Modbus server	<ul style="list-style-type: none"> Record the error message and contact Technical Support
1302	HTTP server fault	<ul style="list-style-type: none"> Record the error message and contact Technical Support
1303	DCT server fault	<ul style="list-style-type: none"> Record the error message and contact Technical Support
1311	Ethernet PHY	<ul style="list-style-type: none"> Record the error message and contact Technical Support
1312	Precision Time Protocol	<ul style="list-style-type: none"> Record the error message and contact Technical Support
1313	EtherNet IP	<ul style="list-style-type: none"> Record the error message and contact Technical Support
1314	PROFINET	<ul style="list-style-type: none"> Record the error message and contact Technical Support
1401 1402	Control Module test	<ul style="list-style-type: none"> Control module self-test error
1403 1404	Power stack test	<ul style="list-style-type: none"> VCM not secured to power stack Power stack self-test error
1501 1502 1503	IO Option identity IO Option processor Unknown IO Option	<ul style="list-style-type: none"> Ensure the IO option is correctly fitted Update the firmware in the inverter. Replace the IO option
1504	IO Option watchdog	<ul style="list-style-type: none"> The IO Option has become disconnected Option reset problem. Upgrade drive firmware to 1.11 or greater to improve the option reset control.
1601	Stack internal fault	<ul style="list-style-type: none"> Return the power stack to Parker Hannifin repair center.
1602	Incompatible stack	<ul style="list-style-type: none"> Return the power stack to Parker Hannifin repair center.
1801	Heatsink thermistor unplugged	<ul style="list-style-type: none"> Return the power stack to Parker Hannifin repair center.
1901	System Board Data	<ul style="list-style-type: none"> The identifying data on the system board is corrupt
1902	System Board Type	<ul style="list-style-type: none"> The system board type is not recognized by this version of drive firmware. Update the firmware to the latest version.
2001	Unimplemented Function	<ul style="list-style-type: none"> Record the error message and contact Technical Support
2002	Memory allocation error	<ul style="list-style-type: none"> Record the error message and contact Technical Support

Autotune Alerts

If the autotune fails to complete for any reason, an alert will be displayed and the autotune abandoned. Alerts are as follows:

Alert message	Possible Cause	Remedy
LEAKAGE L TIMEOUT	The autotune has attempted to determine the leakage inductance of the motor, but cannot make the required test current.	Problem with motor connection.
MOTOR TURNING ERROR	The autotune is trying to find the encoder direction by spinning the motor, but the motor is already spinning.	Wait till the motor stops.
NEGATIVE SLIP FREQ	Autotune has calculated a negative slip frequency, which is not valid. Nameplate rpm may have been set to a value higher than the base speed of the motor.	Check nameplate rpm, base frequency, and pole pairs are correct.
TR TOO LARGE	The calculated value of rotor time constant is too large.	Check the values of Nameplate Speed and Base Frequency.
TR TOO SMALL	The calculated value of rotor time constant is too small.	Check the values of Nameplate Speed and Base Frequency.
MAX SPEED TOO LOW	During Autotune the motor is required to run at the nameplate speed of the motor. If 100% Speed in RPM parameter limits the speed to less than this value, an error will be reported.	Increase the value of 100% Speed in RPM parameter up to the nameplate rpm of the motor (as a minimum). It may be reduced, if required, after the Autotune is complete.
SUPPLY VOLTS LOW	The autotune will compensate for low supply volts, down to 70% of motor rated volts. Below this value it will stop the autotune and raise an alert.	Re-try when mains volts are within specification.
NOT AT SPEED	The motor was unable to reach the required speed to carry out the Autotune.	Possible reasons include: motor shaft not free to turn; the motor data is incorrect.
MAG CURRENT ERROR	It was not possible to find a suitable value of magnetising current to achieve the required operating condition for the motor.	Check the motor data is correct, especially nameplate rpm and motor volts. Also check that the motor is correctly rated for the drive.
KE TOO LARGE	Ke value calculated during the autotune (stationary) is too large (the max value is 840V)	Check the motor data is correct, especially nameplate rpm, rated amps and motor volts. If low speed motor with a Ke value higher than 840V, enter by hand the corresponding value after the autotune completion.
KE TOO SMALL	Ke value calculated during the autotune (stationary) is too small (the min value is 1V)	Check the motor data is correct, especially nameplate rpm, rated amps and motor volts.
ALL TESTS DISABLED	All auto tune tests are disabled	Check parameter 0257: Autotune Test Disable

7-12 Trips & Fault Finding

Other Alerts

Alert message	Possible Cause	Remedy
** ALERT ** DEFAULTS LOADED	First power up with new control module	Initialise all parameters using the GKP setup wizard or PDQ
** ALERT ** APPLICATION MISSING	Fault during application download. Application deleted by the drive	Re-install the application from PDQ or PDD Custom applications only: check the application for any delays or loops that may cause the application task to "hang".
** ALERT ** POWER STACK MISMATCH	Parameter 0987 "Power Stack Required" does not equal the ID of the stack.	Change "Power Stack Required" to match "Power Stack Fitted". After doing this it may be necessary to restore parameters to default and reconfigure the drive. This is to ensure that all parameters have appropriate values.
** ALERT ** APPLICATION DELETED	Application deleted by the drive	Custom applications only: check the application for any delays or loops that may cause the application task to "hang".
** ALERT ** FIRE MODE	Fire Mode has been activated	If this message is not expected, use PDD to check if the Fire Mode block is in the configuration.
COAST TO STOP	Attempting to start the drive in local mode with Coast To Stop active.	The Coast To Stop input is active low. This input needs to be driven high. The input may be ignored in the standard application by setting "Disable Coast Stop".
ENABLE VOLTAGE	Attempting to start the drive in local mode with the Enable input inactive	The Enable input needs to be driven high. This is done in the default application.
QUICKSTOP ACTIVE	Attempting to start the drive in local mode with Quick Stop active.	The Quick Stop input is active low. This input needs to be driven high. The input may be ignored in the standard application by setting "Disable Quick Stop".
OPERATION ENABLED	Attempting to change from Local control to Remote control with the Run signal true	To change to Remote control, (terminals), ensure that the Run input is false.
MAX SPD GT ATN SPD	Parameter 0464 "100% Speed in RPM" has been increased since auto-tune.	Check the value of "100% Speed in RPM". It may be necessary to repeat the auto tune with the higher value of max speed.
** ALERT ** UNKNOWN STACK	The stack is not known to the firmware	Upgrade the drive firmware.

Alert message	Possible Cause	Remedy
** ALERT ** APPLICATION LOAD FAILED	Fault during application download. Application deleted by the drive	Re-install the application from PDQ or PDD Custom applications only: check the application for any delays or loops that may cause the application task to "hang".
COMMS OPTION HARDWARE MISMATCH	Parameter 0044 "Comms Required" is not compatible with the fitted communications option	Fit the correct communications option. Change the application to be compatible with the fitted option, (setting "Comms Required" to NONE will avoid this alert).
COMMS OPTION CONFIGURATION ERROR	The configuration settings are not compatible with the selected option	Refer to the communications option manual, "Troubleshooting".
IO OPTION HARDWARE MISMATCH	Parameter 1178 "Option IO Required" is not compatible with the fitted IO option	Fit the correct IO option. Change the application to be compatible with the fitted option, (setting "Option IO Required" to NONE will avoid this alert).
** ALERT ** FEEDBACK MISSING	Attempt to run in Encoder Feedback control mode with no feedback device fitted, (or configured).	Change the control mode to VHz or Sensorless Fit the correct feedback option Check parameter 1178 "Option IO Required"
** ALERT ** IO OPTION CHANGED	The IO Option has been changed.	IO Option removed, IO Option attached or different IO Option fitted. This alert is for information only and occurs just once following the change.
** ALERT ** COMMS OPTION CHANGED	The Communications Option has been changed.	Comms Option removed, Comms Option attached or different Comms Option fitted. This alert is for information only and occurs just once following the change.
** ALERT ** UPDATING LANGUAGE	Updating the translations held in the GKP. This may happen the first time a language is selected.	No action required. The language update should complete within one minute.
PCR NOT CLOSED	The pre-charge relay is not closed, (probably due to low DC Link volts)	Check the 3-phase input or common supply.
SYSTEM BOARD HARDWARE MISMATCH	Parameter 1739 "System Board Required" not correctly set.	This indicates that the drive has never been commissioned. It is advised to reset all parameters to their default values.
** ALERT ** SYSTEM BOARD CHANGED	Unreliable connection to the system board	Power off / on then verify that the system board is functioning correctly. If this message occurs more than once contact the service department for assistance.

7-14 Trips & Fault Finding

Fault Finding

Problem	Possible Cause	Remedy
Drive will not power-up	Fuse blown	Check supply details, fit correct fuse. Check Product Code against Model No.
	Faulty cabling	Check all connections are correct/secure. Check cable continuity
Drive fuse keeps blowing	Faulty cabling or connections wrong	Check for problem and rectify before replacing with correct fuse
	Faulty drive	Contact Parker
Cannot obtain power-on state	Incorrect or no supply available	Check supply details
Motor will not run at switch-on	Motor jammed	Stop the drive and clear the jam Safe Torque Off circuit active. Check the STO connections then power the drive off and on to clear any latched STO fault.
Motor runs and stops	Motor becomes jammed	Stop the drive and clear the jam
	Open circuit speed reference potentiometer	Check terminal

Black Box Feature

The Black Box feature can be used to help find the source of a trip. Data is saved automatically whenever a trip occurs that causes the drive to stop running. The data records the moments leading up to the trip and the state of the drive when the trip occurs. This may then be transferred to an SD card for off line analysis.

Black Box File Format

When copied to an SD card, the black box feature creates one file for each trip event, or record. The files are called "blackbox_xxxx.csv" where xxxx is replaced with a decimal number that is incremented automatically by the drive every time a trip occurs.

The data recorded in the lead up to the trip is:

- Up to four user defined parameters
- Output Current in phases U and V expressed as a percent of motor rating
- The rotor electrical frequency in Hz.
- The demanded electrical frequency in Hz
- The DC Link volts, (parameter **0392 DC Link Voltage**)
- The temperature of the control card PCB in centigrade, (parameter **0406 CM Temperature**)
- The temperature of the heatsink in centigrade, (parameter **0407 Heatsink Temperature**)
- The sequencing control word, (parameter **0644 Control Word**)
- The sequencing status word, (parameter **0641 Status Word**)
- The input and output digital signals on the stack, words 1 and 2.
- The control card digital output and input latches.
- Various digital inputs to the micro-controller.
- Trip latch state
- Motor sequencer state
- Motor sequencer start and stop states.
- Main sequencer state, (parameter **0678 Sequencing State**)
- High current limit activity
- Stall trip torque limit state
- Stall trip current limit state

7-16 Trips & Fault Finding

The data recorded at the instant of the trip is output at the end of the file. This consists of:

- Control module serial number, (parameter **0977 Control Module Serial**)
- Time of the trip. This is either the control board age, or the time from the optional Real Time Clock if fitted.
- State of all other trips, active or warning.
- Count of total motor starts, (parameter **1732 Motor Start Count**)
- Count of total times the 3-phase has been powered
- For each trip, a count of the total times that trip has been activated.
- A record of near trip events for Over Current, Over Voltage and Under Voltage.
- The product code of the drive, expressed as a number in internal format.
- The IO Option fitted, (parameter **1179 Option IO Fitted**)
- The Communications Option fitted, (parameter **0045 Comms Fitted**)
- The System board type, (parameter **1740 System Board Fitted**)
- The motor control type, (parameter **0511 Motor Type or AFE**)
- The control strategy, (parameter **0512 Control Strategy**)
- The control type, (parameter **1533 Control Type**)
- The firmware version
- The version of CoDeSys used to create the application.

Diagnostic LEDs

There are two diagnostic LEDs fitted next to the SD Card slot. The Health LED is on the left, closest to the connector for the GKP. The flash period is 1s when the drive firmware is active and 2s in the Firmware Update mode

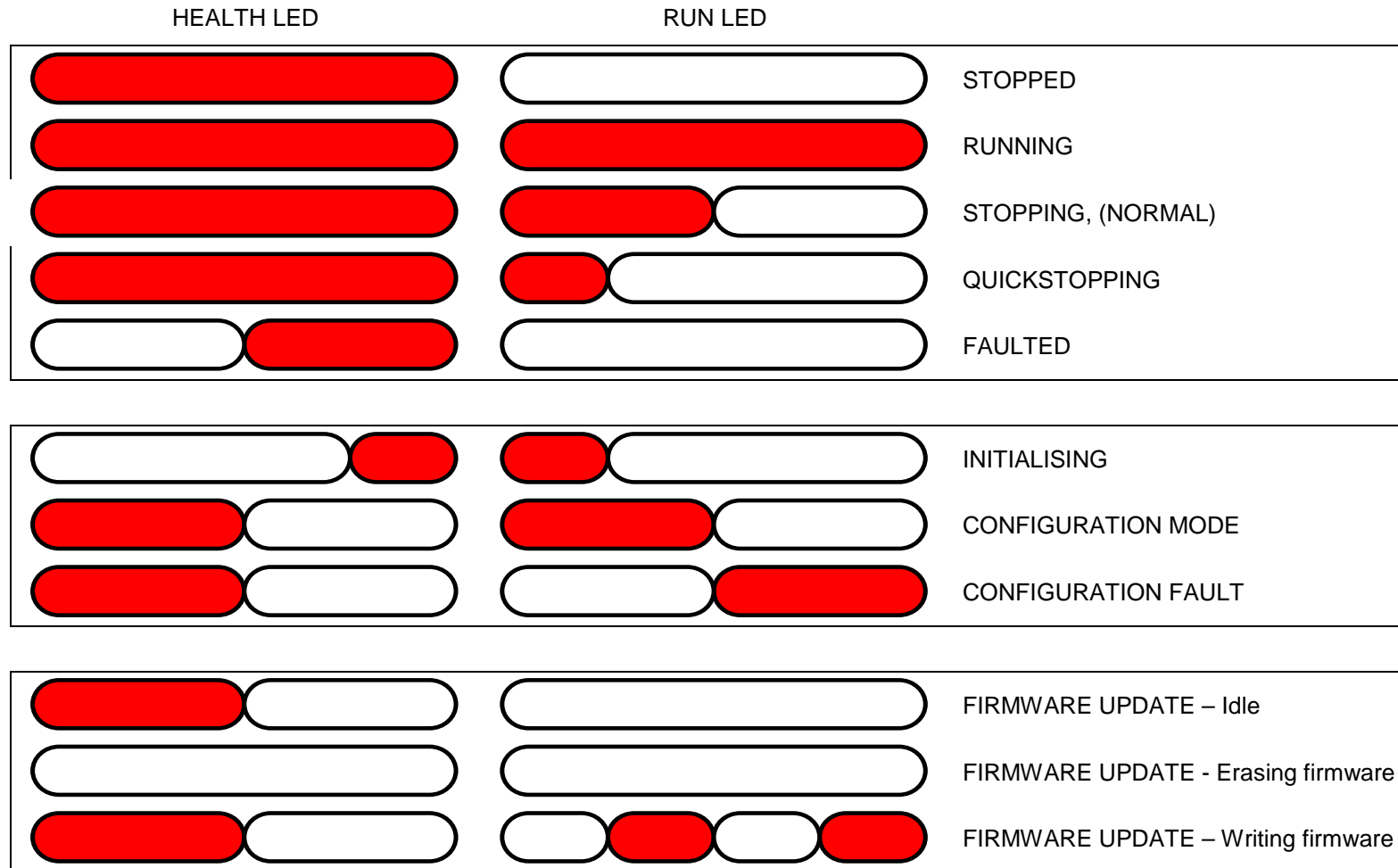

7-18 Trips & Fault Finding

Chapter 8: Ethernet

Communications to the inverter is via Ethernet on the Control Module. This allows access to:

- The PDQ and PDD PC programming tools
- The Modbus TCP server (see Appendix A – Fieldbuses: Modbus TCP)
- The HTTP server (see section below)
- Application access to the Ethernet including peer-to-peer communications
- EtherNet/IP adapter (see Appendix A – Fieldbuses: EtherNet/IP Adapter)
- IEEE 1588v2 Precision Time Protocol

The Ethernet operates at 10/100 MHz, half/full duplex. Internet Protocol version 4 (IPv4) is supported.

The AC30P or AC30D has a built-in Ethernet switch with two external Ethernet ports allowing for daisy chaining of inverters.

Connecting to the Inverter

Recommended Cable

CAT5e screened or CAT6 screened Ethernet cable is recommended.

AC30V

Insert the Ethernet cable as shown below on an AC30V. Connection is recommended via an Ethernet switch.

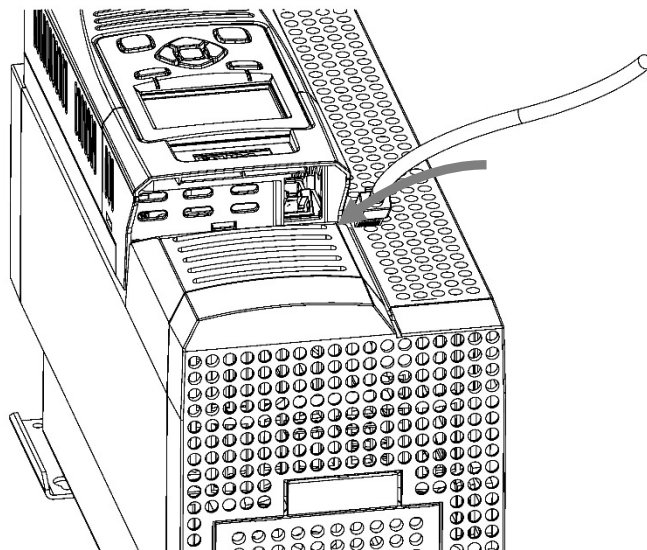

To remove the cable first remove the GKP and then insert a screwdriver to release the catch on the Ethernet clip.

Ethernet LEDs
Activity Link

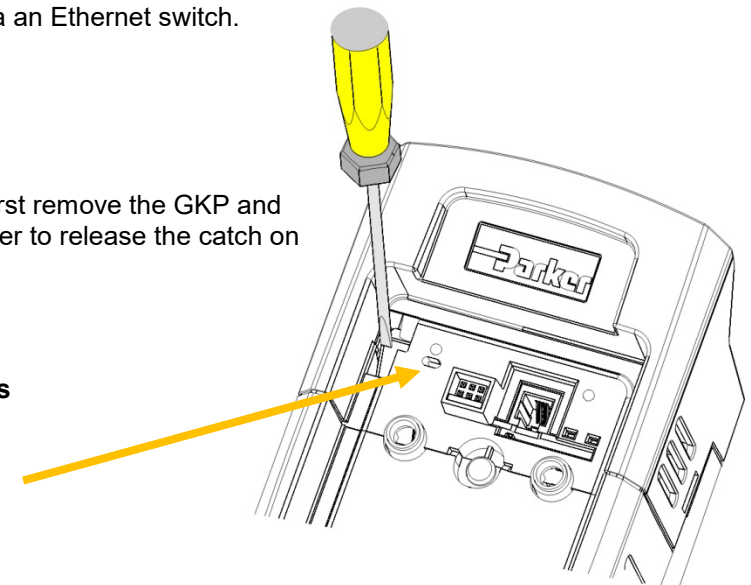

8-2 Ethernet

AC30P or AC30D

Port 1 LEDs

Activity 

Link 

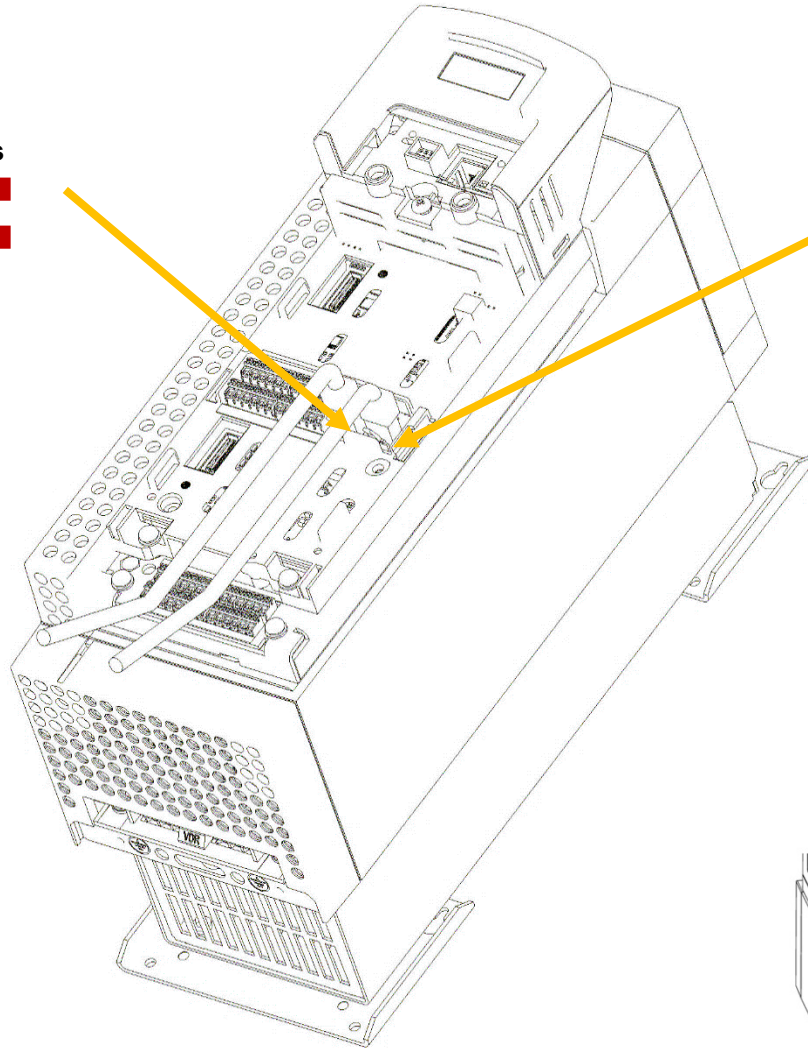

Port 2 LEDs

Activity 

Link 



DO NOT TOUCH

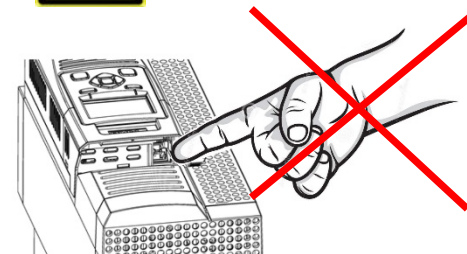

DO NOT touch the board surface via the aperture shown

Insert the Ethernet cable on an AC30P or AC30D as shown below.

Ethernet Setup

Configuration

To enable communications over the Ethernet an IP address must be set. With the default setting, an attempt at automatically obtaining an IP address will be made.

Note: The IP address will be obtained or modified when an Ethernet cable is connected or the inverter is powered-up.

For the AC30P or AC30D if one port is already connected to a network, the IP address of the inverter will not be modified when the other port is connected to a network.

The state of the Ethernet can be monitored using the parameter **0919 Ethernet State** and from the Ethernet icon  on the GKP status bar.

The current IP settings of the inverter can be monitored using the following parameters:

0926 IP Address

0927 Subnet Mask

0928 Gateway Address

The MAC address of the Ethernet port is fixed at the factory and can be read using the parameter **0945 MAC Address**

Advanced Configuration

The IP address on the inverter may be set using the following methods:

- Manually to a fixed address
- Automatically by a DHCP server connected on the network
- Automatically by the inverter to a link-local address using Auto-IP (also known as Automatic Private IP Addressing)

The parameters **0929 DHCP** and **0930 Auto IP** are used to determine how the IP address is set. The default of these two parameters is TRUE.

The parameter **0936 Setting Lock**, when set to TRUE, prevents a configuration tool from modifying the IP settings.

8-4 Ethernet

Manually Setting the IP Address

Parameter	Setting
0929 DHCP	FALSE
0930 Auto IP	FALSE
0933 User IP Address	<i>Preferred IP Address</i>
0934 User Subnet Mask	<i>Preferred Subnet Mask</i>
0935 User Gateway Address	<i>Preferred Gateway Address</i>

To set the IP address manually both the DHCP and Auto-IP must be disabled. The IP address, subnet mask and gateway address will be set from the values in the parameters **0933 User IP Address**, **0934 User Subnet Mask**, **0935 User Gateway Address**.

If the network does not have a gateway to another network then the gateway address may be set to 0.0.0.0

Automatically Assigning an IP Address using DHCP

Parameter	Setting
0929 DHCP	TRUE
0930 Auto IP	FALSE

If the network on which the inverter is connected has a DHCP (Dynamic Host Configuration Protocol) server then the IP address may be assigned by this server. The DHCP must be enabled. The inverter will then request an IP address, subnet mask and gateway address from the DHCP server.

Note: There is no guarantee that the DHCP server will provide the same IP address each time. The IP address is requested by the inverter when the Ethernet port is connected to a network or when the inverter is powered up.

Automatically Assigning an IP Address using Auto-IP

Parameter	Setting
0929 DHCP	FALSE
0930 Auto IP	TRUE

The inverter may assign itself a link-local address automatically using Auto-IP. This would be used where an automatic address is required but where no DHCP server is available, such as a small local network or when connecting an inverter directly to a PC (point to point). The Auto-IP must be enabled.

The inverter will choose an IP address randomly from the link-local range **169.254.*.***. The AC30 checks that no other Ethernet device on the network is using the address before allocating it. The Inverter will store this IP address (in parameter **0931 Last Auto IP Address**) and attempt to use it next time Auto-IP is used. The gateway address is fixed to 0.0.0.0

Using Both DHCP and Auto-IP

Parameter	Setting
0929 DHCP	TRUE
0930 Auto IP	TRUE

If both the DHCP and Auto-IP are enabled then an IP address will be obtained automatically depending on the network. This is the default setting.

The inverter will take a link-local address in the range 169.254.*.* if no DHCP server is discovered on the network. If a DHCP server is available (or becomes subsequently available) then the inverter will take the IP address from the server. Note that the DHCP has precedence.

8-6 Ethernet

Typical Wiring Configurations

On the AC30P or AC30D either Ethernet port may be used.

Point to Point Connection



When connecting a PC directly to an inverter either:

- Both sides use local-link addresses 169.254.*.* (recommended) , or
- Both sides are set with a fixed IP address (each must be different and on the same subnet)

When using local-link addresses the parameter **0930 Auto IP** must be set to TRUE (see the section *Automatically Assigning an IP Address using Auto-IP*). Normally the PC is already configured to allow for an Automatic Private IP address. However if problems are encountered check the PC's network settings (see the section *Troubleshooting the Ethernet – Changing the Ethernet settings on the PC*).

Note: It may take some PCs up to 2 minutes to obtain an Automatic private IP address when the Ethernet cable is plugged in.

Local Network with a DHCP Server

For the inverter, the parameter **0929 DHCP** must be set to TRUE (see the section *Automatically Assigning an IP Address using DHCP*).

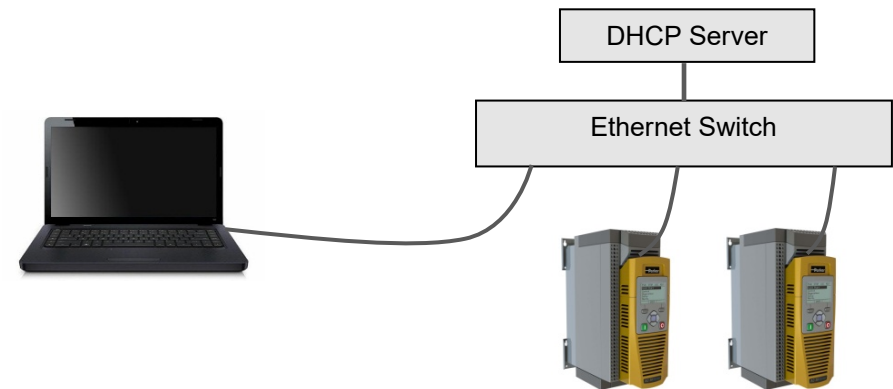

Local Network without a DHCP Server

Devices on the network either:

- Use fixed addresses, in which case the parameters **0929 DHCP** and **0930 Auto IP** must be set to FALSE (see the section *Advanced Configuration - Manually Setting the IP Address*), or
- Use link-local addresses, in which case the parameter **0930 Auto IP** must be set to TRUE (see the section *Advanced Configuration - Automatically Assigning an IP Address using Auto-IP*).

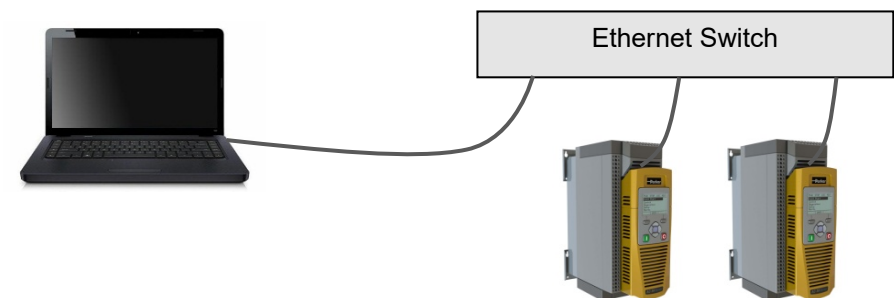

Ethernet Daisy Chaining

The Ethernet on the AC30P or AC30D may be daisy-chained. The order of the ports is not important, but it is recommended to follow the order of, for example, Port 2 on the left-hand side inverter to Port 1 on the right-hand side inverter. However, an Ethernet loop **MUST** be avoided.



8-8 Ethernet

Ethernet Parameter Summary

Parameter Name	No.	Path	Default	Range	Units	Writable																		
Ethernet State	0919	Monitor::Communications::Base Ethernet Parameters::Base Comms:: Ethernet	0:INITIALISING	0:INITIALISING 1:NO LINK 2:RESOLVING IP 3:RESOLVING DHCP 4:RESOLVING AUTO-IP 5:RESOLVED IP 6:STOPPING DHCP 7:DUPLICATE IP 8:FAULT		NEVER																		
<p>Ethernet parameter. Provides the state of the inverter Ethernet link.</p> <p>Enumerated values:</p> <table> <tr> <td>0: INITIALISING</td> <td>- Driver initialising</td> </tr> <tr> <td>1 :NO LINK</td> <td>- Ethernet not connected to a network</td> </tr> <tr> <td>2: RESOLVING IP</td> <td>- Waiting for an IP address to be set manually</td> </tr> <tr> <td>3: RESOLVING DHCP</td> <td>- Waiting for a DHCP server to provide an IP address</td> </tr> <tr> <td>4: RESOLVING AUTO-IP</td> <td>- Waiting to Auto-IP to provide an IP address</td> </tr> <tr> <td>5: RESOLVED IP</td> <td>- IP address is set – communication is possible</td> </tr> <tr> <td>6: STOPPING DHCP</td> <td>- Inverter is stopping the DHCP service</td> </tr> <tr> <td>7: DUPLICATE IP</td> <td>- Another device on the network has the same IP address</td> </tr> <tr> <td>8: FAULT</td> <td>- Fault detected</td> </tr> </table>							0: INITIALISING	- Driver initialising	1 :NO LINK	- Ethernet not connected to a network	2: RESOLVING IP	- Waiting for an IP address to be set manually	3: RESOLVING DHCP	- Waiting for a DHCP server to provide an IP address	4: RESOLVING AUTO-IP	- Waiting to Auto-IP to provide an IP address	5: RESOLVED IP	- IP address is set – communication is possible	6: STOPPING DHCP	- Inverter is stopping the DHCP service	7: DUPLICATE IP	- Another device on the network has the same IP address	8: FAULT	- Fault detected
0: INITIALISING	- Driver initialising																							
1 :NO LINK	- Ethernet not connected to a network																							
2: RESOLVING IP	- Waiting for an IP address to be set manually																							
3: RESOLVING DHCP	- Waiting for a DHCP server to provide an IP address																							
4: RESOLVING AUTO-IP	- Waiting to Auto-IP to provide an IP address																							
5: RESOLVED IP	- IP address is set – communication is possible																							
6: STOPPING DHCP	- Inverter is stopping the DHCP service																							
7: DUPLICATE IP	- Another device on the network has the same IP address																							
8: FAULT	- Fault detected																							
MAC Address	0920	Monitor::Communications::Base Ethernet Parameters::Base Comms:: Ethernet	00-00-00-00-00-00	xx-xx-xx-xx-xx-xx		NEVER																		
<p>Ethernet parameter. Provides the Ethernet MAC address.</p>																								
IP Address	0926	Monitor::Communications::Base Ethernet Parameters::Base Comms:: Ethernet	0.0.0.0	0.0.0.0 to 255.255.255.255		NEVER																		
<p>Ethernet parameter. Provides the current IP address of the Ethernet</p>																								

Parameter Name	No.	Path	Default	Range	Units	Writable
Subnet Mask	0927	Monitor::Communications::Base Ethernet Parameters::Base Comms:: Ethernet	0.0.0.0	0.0.0.0 to 255.255.255.255		NEVER
Ethernet parameter. Provides the current subnet mask of the Ethernet.						
Gateway Address	0928	Monitor::Communications::Base Ethernet Parameters::Base Comms:: Ethernet	0.0.0.0	0.0.0.0 to 255.255.255.255		NEVER
Ethernet parameter. Provides the current gateway address of the Ethernet.						
Last Auto IP Address	0931	Parameters::Base Comms:: Ethernet	0.0.0.0	0.0.0.0 to 255.255.255.255		NEVER
Ethernet parameter. Provides the last Auto-IP IP address used.						
Ethernet Diagnostic	0937	Parameters::Base Comms:: Ethernet	0000 0000h	0000 0000h to FFFF FFFFh		NEVER
Ethernet parameter. Diagnostic for the Ethernet.						
DHCP State	1269	Parameters::Base Comms:: Ethernet	0000 0000h	0000 0000h to FFFF FFFFh		NEVER
Ethernet parameter. Diagnostic for the Ethernet DHCP client.						
Free Packets	0938	Parameters::Base Comms:: Ethernet	0	0 to 100		NEVER
Ethernet parameter. Diagnostic providing the remaining number of Ethernet packets						
Free Sockets	1782	Parameters::Base Comms:: Ethernet	0	0 to 255		NEVER
Ethernet parameter. Diagnostic providing the remaining number of BSD sockets.						

8-10 Ethernet

Parameter Name	No.	Path	Default	Range	Units	Writable
DHCP	0929	Setup::Communications::Base Ethernet Parameters::Base Comms:: Ethernet	TRUE	FALSE TRUE		ALWAYS
Ethernet parameter. DHCP enable. Set to TRUE to obtain an IP address from the connected DHCP server.						
Auto IP	0930	Setup::Communications::Base Ethernet Parameters::Base Comms:: Ethernet	TRUE	FALSE TRUE		ALWAYS
Ethernet parameter. DHCP enable. Set to TRUE to obtain an IP address using Auto-IP.						
User IP Address	0933	Setup::Communications::Base Ethernet Parameters::Base Comms:: Ethernet	0.0.0.0	0.0.0.0 to 255.255.255.255		ALWAYS
Ethernet parameter. The preferred fixed IP address of the Ethernet. For the Ethernet to take on this address both DHCP and Auto-IP must be disabled.						
User Subnet Mask	0934	Setup::Communications::Base Ethernet Parameters::Base Comms:: Ethernet	0.0.0.0	0.0.0.0 to 255.255.255.255		ALWAYS
Ethernet parameter. The preferred fixed subnet mask of the Ethernet. For the Ethernet to take on this address both DHCP and Auto-IP must be disabled.						
User Gateway Address	0935	Setup::Communications::Base Ethernet Parameters::Base Comms:: Ethernet	0.0.0.0	0.0.0.0 to 255.255.255.255		ALWAYS
Ethernet parameter. The preferred fixed gateway address of the Ethernet. For the Ethernet to take on this address both DHCP and Auto-IP must be disabled.						
Lock	0936	Parameters::Base Comms:: Ethernet	FALSE	FALSE TRUE		ALWAYS
Ethernet parameter. When set to TRUE, this prevents the IP settings being changed via an IP configuration tool. The IP settings may still be modified from the GKP and the inverter web Parameters page.						

Troubleshooting the Ethernet

The following parameters are useful for monitoring the IP settings:

0929 IP Address

0928 Subnet Mask

0931 Gateway Address

The state of the Ethernet can be monitored using the parameter **944 Ethernet State**, normal operation is when the state is **RESOLVED IP**, and from the GKP icon 

No IP address - flashing GKP icon

Normally, once the inverter is connected to a network, the GKP Ethernet icon will flash for a short period as the IP address is being resolved, and then will become a solid icon indicating an IP address has been set. If the icon continues to flash for more than 1 – 2 minutes this can indicate a problem. Check the parameter **0919 Ethernet State**.

Resolving IP

The inverter is waiting for a valid IP address to be set automatically, or manually using the parameters:

0933 User IP Address

0934 User Subnet Mask

0935 User Gateway Address

Note that the IP address must be set to a non-zero value.

Resolving DHCP

The inverter is waiting for a DHCP server to provide an IP address. If there is no DHCP server detected on the network then the Ethernet will stay in this state. If there is no DHCP server the IP address may be obtained using Auto-IP or set manually.

Duplicate IP

Another device on the network with the same IP address has been detected. This will cause communication issues. The Duplicate IP warning will clear after approximately 1 minute once the conflicting device has been removed or the IP address changed.

Fault

An Ethernet loop has been detected. To clear the fault, break the loop by removing an Ethernet cable from one of the ports.

8-12 Ethernet

An IP address is set but there is no communication

If there is an IP address set but there are problems communicating with other devices (say a PC) then the IP address may not match the subnet on which it is connected. The range of the IP address permitted on a network depends upon the particular network. Normally if the IP address is obtained automatically then the settings will be correct for the network.

If connecting to a PC, the PC settings should also be checked – see the section *Changing the Ethernet settings on the PC*.

The administrator of a network should be aware of what IP settings are required.

Link detection

When the inverter Ethernet is connected to a network or other device, the Ethernet Link LED will be on and the Ethernet Activity LED will be flickering.

When first connected, the inverter will attempt to determine the speed and duplex of the Ethernet link. This is done using a method call auto-negotiation.

Some older devices or hubs do not support auto-negotiation, in which case the inverter will use parallel detection. As parallel detection will only provide the link speed, the inverter will default to half-duplex.

Changing the Ethernet settings on the PC

Normally the PC Ethernet adapter is set to obtain an IP address automatically either from a DHCP server or using an automatic private IP address (Auto-IP). The adapter settings may be checked / modified as follows:

For **Windows XP** under Control Panel → Network Connections

For **Windows 7** under Control Panel → Network And Sharing Center → Change adapter settings

Right-click on the required network adapter and choose Properties, then double-click on **Internet Protocol (TCP/IP)** (Windows XP) or **Internet Protocol Version 4 (TCP/IPv4)** (Windows 7).

To use a fixed IP address make sure **Use the following Ip address** under the **General** tab is chosen and enter the required IP address, subnet mask and default gateway.

To use DHCP or Auto-IP make sure **Obtain IP address automatically** under the **General** tab is selected and under the **Alternate Configuration** tab that **Automatic private IP** address is selected.

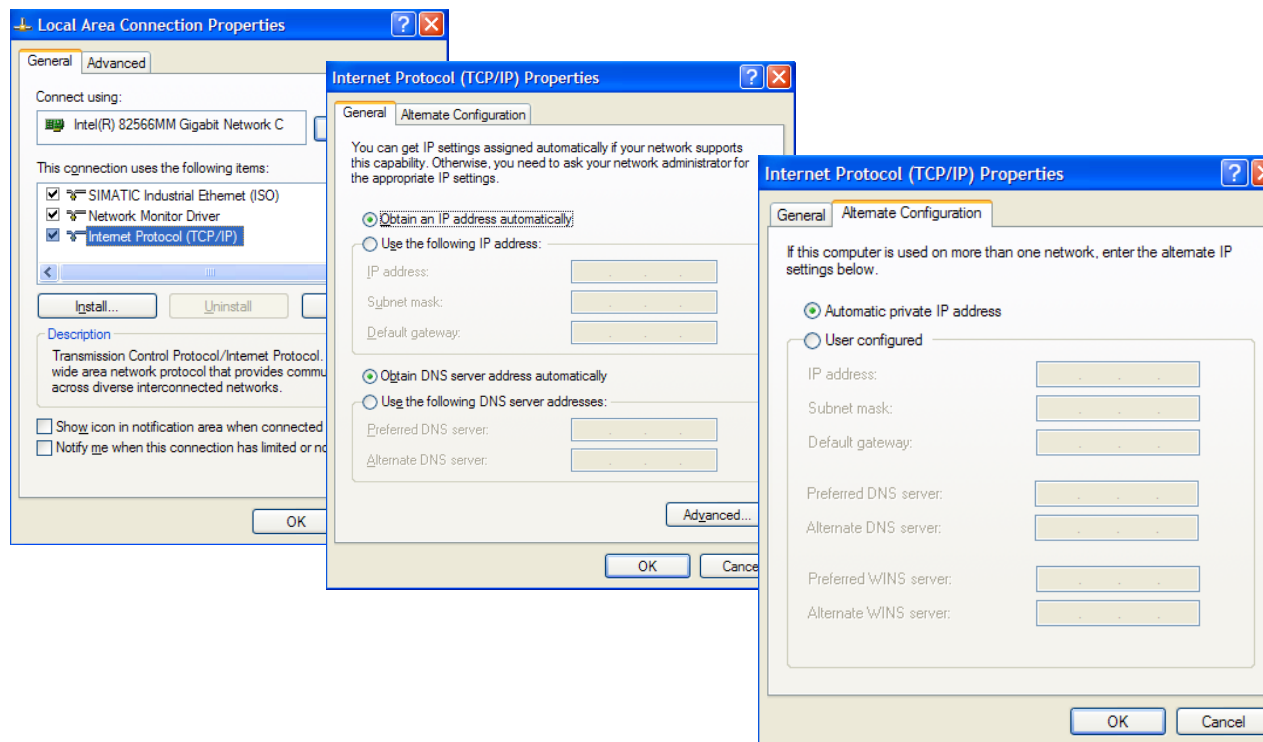

8-14 Ethernet

Web (HTTP) Server

The inverter has a built-in web server. To access the web server the parameter **0944 Web Access** must be set to **LIMITED** (default) or **FULL**.

To access the inverter, enter the IP address into a web browser. The following browsers are suitable:

- Internet Explorer 10 or above
- Mozilla Firefox 33 or above
- Google Chrome 48 or above

Web Pages

A number of built-in web pages can be accessed from the inverter.

Summary Page

The Summary page displays a summary of the inverter.

Parameters Page

The Parameters page provides access to the inverter parameters similar to the GKP. This page may only be accessed when the parameter **0944 Web Access** is set to **FULL**. The view level of the parameters may be modified using the parameter **0945 Web View Level**.

Parameters may be modified from this web page. If a parameter is successfully modified, and supports save, it will be saved if the parameter **1738 Enable Auto Save** is set to TRUE. If Enable Auto Save is set to FALSE then the Save button will appear in the parameter menu navigation bar. Pressing the Save button will save all parameters.

Some parameters may only be modified when in configuration mode, in which case the parameter number will be highlighted **orange**.
Some parameters may only be modified when the motor is stopped, in which case the parameter number will be highlighted **purple**.

It is recommended to use the refresh button provided on the parameter menu navigation bar, rather than on the browser itself, to view the latest parameter values.

Parameters may be continuously monitored by clicking on the “monitoring” button on the parameter menu navigation bar.

If a web access password is set (see Services Page section below) then this must be entered in the pop-up box on the browser correctly to be able to gain full access to the web page. If the pop-up box is cancelled then a read-only Parameters page will be shown. The read-only web page allows parameters to be viewed but not changed.

Change parameter web view level

Put the inverter into operational or configuration mode

Inverter status

Application status

Parameter menu navigation bar

Parameters

Summary | Parameters | Services

ENGINEER ▾

▶ ■

OK OPERATIONAL

Home ▶ Parameters ▶ Inputs And Outputs ▶ IO Configure

Refresh

0001: Anin 01 Type	-10..10 V	Set
0957: Anin 01 Offset	0.00 %	Set
0958: Anin 01 Scale	1.0000	Set
0002: Anin 02 Type	-10..10 V	Set

Enable / disable continual monitoring of parameters

Refresh parameter values

Services Page

The Services page allows the Web Password to be changed. The password provides a means of restricting access to the web pages using Basic Authenticate. By default the password is cleared providing unrestricted access.

The username is fixed to “ac30”.

Note 1. Basic Authenticate is a very low level of defence against unauthorized access. It is the responsibility of the system administrator to assess the network security and provide adequate protection.

Note 2. The username and password are case sensitive.

Note 3. If passwords are lost, they may only be cleared by a return to defaults of all the parameters.

8-16 Ethernet

Web Server Parameter Summary

Parameter Name	No.	Path	Default	Range	Units	Writable
Web Access	0944	Setup::Communications::Base Ethernet Parameters::Base Comms::Web Server	1:LIMITED	0:DISABLED 1:LIMITED 2:FULL		ALWAYS
<p>Web Server parameter. Enables access to the inverter web server.</p> <p>Enumerated values: 0: DISABLED – a web browser is prevented from accessing the inverter web server. 1: LIMITED – a web browser may access a limited set of pages on the inverter web server. 2: FULL – a web browser has full access to the pages on the inverter web server, however authentication will be required if a password has been set.</p>						
Web View Level	0945	Parameters::Base Comms::Web Server	1:TECHNICIAN	0:OPERATOR 1:TECHNICIAN 2:ENGINEER		ALWAYS
<p>Web Server parameter. Sets the view level when accessing parameters via the web server.</p> <p>Enumerated values: 0: OPERATOR 1: TECHNICIAN 2: ENGINEER</p>						
Web Password	0946	Parameters::Base Comms::Web Server	none	-		ALWAYS
<p>Web Server parameter. Sets the password for access to restricted inverter web pages such as the Parameters Page. This may only be changed on the web Services page.</p>						

Troubleshooting the Web Server

Troubleshooting of the Ethernet in general is described in the section Troubleshooting below.

If the inverter web page still cannot be accessed then this may be due to the browser's **proxy server** settings, especially if the PC has been used on a corporate network. To check the settings, access the **Internet Options** dialog from within the browser and click on the **Connections** tab, then click on **LAN settings**. Make sure the **Proxy server** checkbox is cleared, alternatively click on **Advanced** and add the IP address of the inverter to the **Exceptions** list.

Contact your network administrator before making any changes to your browser settings.

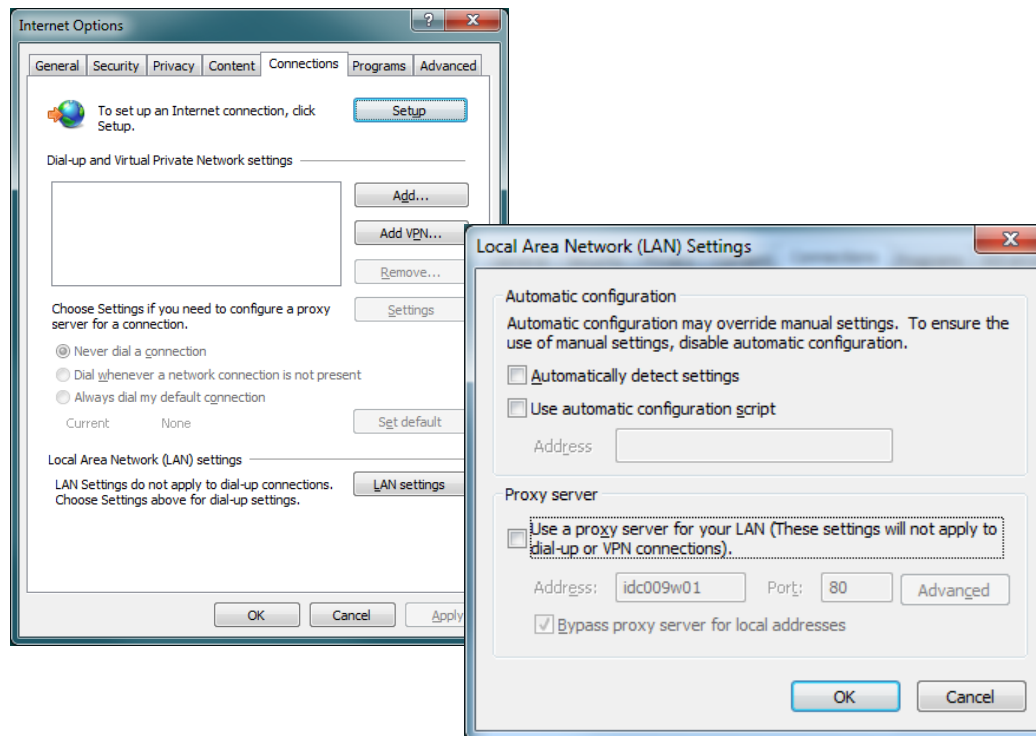

8-18 Ethernet

Simple Network Time Protocol (SNTP) Client

The SNTP Client is implemented in the AC30P and AC30D inverters.

The SNTP Client may be used to connect to a Network Time Protocol server on the World Wide Web. When configured, the SNTP Client automatically updates PNO1186 “Time and Date” to the current UTC time, (Co-ordinated Universal Time).

SNTP Client Parameter Summary

Parameter Name	No.	Path	Default	Range	Units	Writable
SNTP Client Enable	1788	Parameters::Base Comms::SNTP Client	FALSE	FALSE TRUE		ALWAYS
Enables the Simple Network Time Protocol Client						
SNTP Remote Server	1789	Parameters::Base Comms::SNTP Client	0.0.0.0			ALWAYS
Defines the TCP/IP address of the NPT server to connect to. If left at 0.0.0.0 the AC30 will use PNO 0928 “Gateway Address” as the address for the NTP server.						
SNTP Status	1386	Parameters::Base Comms::SNTP Client		0: IDLE 1: UPDATING 2: OK 3: BIND ERROR 4: CONNECT ERROR 5: TRANSMIT ERROR 6: RECEIVE ERROR 7: RECEIVE TIMEOUT		NEVER

The SNTP Client occasionally requests a time update from the server. If the update fails the reason is shown here.

SNTP Client Operation

The SNTP client sends a request to the NTP server specified in the parameter “SNTP Remote Server”. On receiving a reply the client updates the time in the AC30. The request rate varies between 64s and 1024s, (about 17 minutes). The actual period between requests is based on the error between the local time and the server time at the instant of the request. The smaller the error, the longer the request period.

If an option is fitted that includes a Real Time Clock, the RTC is also updated by the SNTP Client if the RTC and SNTP time are more than 1s apart.

SNTP Relationship with time zone and Daylight Saving

SNTP time is transferred as UTC, (Coordinated Universal Time), which is equivalent to GMT. The AC30 maintains a local copy of UTC. If fitted, the time held in the RTC option is also held in UTC. To display time in the correct time zone there are two parameters, PNO1228 Time Zone Offset, and PNO1225 DST Active. Set the Time Zone Offset to control the difference in hours between the local time zone and UTC. If Daylight Saving Time is active, set DST Active to add one hour to the displayed time.

Simple Network Time Protocol (SNTP) Server

The SNTP Server is implemented in the AC30P and AC30D inverters.

The SNTP Server may be used to share the time and date within a local network.

SNTP Server Parameter Summary

Parameter Name	No.	Path	Default	Range	Units	Writable
SNTP Server Enable	1891	Parameters::Base Comms::SNTP Server	FALSE	FALSE TRUE		ALWAYS

Enables the Simple Network Time Protocol Server

SNTP Server Operation

The server requires no configuration other than a simple enable / disable. It will respond to requests from SNTP clients, returning the time from the local parameter PNO1186 "Time and Date". This may be useful in a local network that has no access to the World Wide Web or any other PC or Ethernet device that has a local time source. In this case the AC30 with the server enabled should be fitted with a Real Time Clock to allow the time to be preserved during a power outage. The local RTC hardware only tracks time to the nearest second. This limits the precision of the AC30 SNTP server.

The SNTP server transmits UTC time, see above for a description of the relationship between UTC time, the local time zone and daylight saving.

8-20 Ethernet

Precision Time Protocol (PTP)

The Precision Time Protocol (IEEE 1588v2 or IEEE 1588-2008) is implemented in the AC30P and AC30D inverters.

The PTP will synchronize the internal clocks over the Ethernet to better than 1 microsecond. No external master is required for the PTP network; any of the inverters may become a PTP master.

The initial use of the PTP is for shaft locking applications using the Virtual Master or Real Master control.



Note: Currently up to 16 inverters are supported on a PTP network.

Configuration

The two Ethernet ports provide a means of daisy chaining the inverters. The port order is not important, but an Ethernet loop must be avoided. An external Ethernet switch should not be used, unless it is an IEEE 1588v2 transparent switch, as this will reduce the synchronization accuracy by an indeterminate amount. Ethernet cables should be kept to a minimum length possible.

To enable the PTP set the parameter **1661 PTP Enable** to TRUE on all inverters participating.

In a PTP network, one device will be a master clock and the others will be slave clocks. On the AC30P or AC30D any inverter can become a master or a slave clock. The decision on which inverter becomes the master is automatic when using the default parameter configuration. However, it is possible to influence which becomes a master or slave by changing the PTP parameters.

Whilst the inverter is synchronising the icon on the GKP status bar  will flash. Once an inverter has become synchronised to the master clock or has become the master clock, the diagnostic parameter **1688 PTP Locked** will be set to TRUE and the GKP icon  will stop flashing.

Advanced Configuration

PTP Modes

One-Step and Two-Step modes: In one-step mode the hardware timestamping directly modifies the network packets, in two-step mode the timestamps are stored and sent in a second step.

End-to-End (E2E) and Peer-to-Peer (P2P) Delay modes: In E2E mode the slaves determine the delay between them and the master over the whole network from end to end. In P2P mode each device only determines the delay to their nearest neighbour and adds this to the packets. Standard Ethernet switches may be used with the E2E mode but is not recommended as it can add an indeterminate delay between clocks.

Address and ports

The PTP protocol uses the multicast IP address 224.0.1.129 and UDP ports 319 (event) and 320 (general).

PTP Profile

Each PTP device has a set of attributes as define by IEEE1588-2008. On the inverter the default attributes values are set as follows. Note that some may be modified by a parameter.

Attribute	Description	Inverter default value	Modified by parameter
domainNumber	A domain consists of one or more PTP devices communicating with each other. Devices on the same domain will have the same domain number.	0	1787 PTP Domain Number
slaveOnly	When slaveOnly is TRUE the PTP device may only be a slave and not become a master clock.	FALSE	1684 PTP Clock Type
logAnnounceInterval	A port in the MASTER state will periodically transmit an Announce message. Announce messages will be transmitted such that the logarithm to the base 2 of the mean value of the interval in seconds between message transmissions is the value of the logAnnounceInterval .	1 (2 seconds)	-
logSyncInterval	A port in the MASTER state will periodically transmit a Sync message. Sync messages will be transmitted such that the logarithm to the base 2 of the mean value of the interval in seconds between message transmissions is the value of the logSyncInterval .	-1 (0.5 seconds)	1681 PTP Log Sync Interval
logMinDelayReqInterval	The logMinDelayReqInterval will specify the minimum permitted mean time interval between successive Delay_Req messages. This value is determined and advertised by a master clock based on the ability of the master clock to process the Delay_Req message traffic.	0	-
announceReceiptTimeout	The value of announceReceiptTimeout will specify the number of announceInterval that has to pass without receipt of an Announce message	3	-

8-22 Ethernet

The following attributes are used to determine the best master clock. They are listed in order of precedence.

Attribute	Description	Inverter Default Value	Modified by parameter
priority1	Lower values of Priority1 take precedence.	128	-
clockClass	Used to define a clock's TAI traceability.	248 or 255 (slave only)	-
clockAccuracy	Indicates the expected accuracy of a clock. Given as an enumerated value.	FEh	-
offsetScaledLogVariance	This defines the stability of the clock.	FFFFh (not computed)	-
priority2	Lower values of Priority2 take precedence.	128	1686 PTP Priority2
clockIdentity	The clockIdentity identifies a clock. The clockIdentity is an 8-octet identifier created from the Ethernet MAC address in the format: First 3 octets – most significant octets of MAC address Next 2 octets – have values FFh and FEh respectively Last 3 octets – least significant octets of MAC address The clockIdentity is used as a tie-breaker for the master clock.	-	0920 MAC Address

PTP Parameter Summary

Note: The value of the PTP configuration parameters only become active when the PTP module initialises, i.e. on inverter power-up, on transition of the parameter 1661 PTP Enable to TRUE or connection of one or more Ethernet cables.

Parameter Name	No.	Path	Default	Range	Units	Writable
PTP Enable	1661	Setup::Communications::PTP Parameters::Base Comms::PTP	FALSE	FALSE TRUE		ALWAYS
<p>PTP parameter. Enables the precision time protocol.</p>						
PTP Clock Type	1684	Setup::Communications::PTP Parameters::Base Comms::PTP	0: MASTER OR SLAVE	0:MASTER OR SLAVE 1:SLAVE ONLY		ALWAYS
<p>PTP parameter Sets if the inverter can become a master or slave clock, or a slave clock only.</p> <p>Enumerated values:</p> <p>0: MASTER OR SLAVE - the device clock will become a Master if it is determined to be the best master in a network, otherwise it will become a Slave</p> <p>1: SLAVE ONLY - the device clock can only become a Slave</p>						
PTP Clock Mode	1683	Setup::Communications::PTP Parameters::Base Comms::PTP	0:E2E	0:E2E		ALWAYS
<p>PTP parameter. Sets the PTP clock mode to either end-to-end (E2E) or peer-to-peer (P2P). See description in section <i>Advanced Users</i> for more details. Note that currently E2E is only available.</p> <p>Enumerated values:</p> <p>0: E2E</p>						
PTP Domain Number	1787	Setup::Communications::PTP Parameters::Base Comms::PTP	0	0 to 127		ALWAYS
<p>PTP parameter. Sets the Domain Number of the inverter. A PTP device will only communicate with other PTP devices that have the same domain number even if it is on the same physical network.</p>						

8-24 Ethernet

Parameter Name	No.	Path	Default	Range	Units	Writable
PTP Log Sync Interval	1681	Setup::Communications::PTP Parameters::Base Comms::PTP	-1	-1 to 0		ALWAYS
<p>PTP parameter.</p> <p>Sets the Log Sync Interval. See description in section <i>Advanced Configuration</i> for more details. This parameter should be set to the same value on all inverters using PTP.</p>						
PTP Priority2	1686	Setup::Communications::PTP Parameters::Base Comms::PTP	128	0 to 255		ALWAYS
<p>PTP parameter.</p> <p>Sets the Priority 2 used as part of the process in determining which PTP device becomes the master clock. See description in section <i>Advanced Configuration</i> for more details.</p>						
PTP Lock Threshold	1685	Setup::Communications::PTP Parameters::Base Comms::PTP	0.5 us	0.1 us to 100 us	us	ALWAYS
<p>PTP parameter.</p> <p>Sets the Lock Threshold when the inverter is a slave clock. When the average offset between the slave clock and the master clock falls below the Lock Threshold then the slave clock is deemed to be synchronised as indicated by the parameter 1688 PTP Locked. Note that it will take longer for a slave clock to be deemed synchronised when a smaller threshold is set.</p>						

Parameter Name	No.	Path	Default	Range	Units	Writable
PTP State	1689	Monitor::Communications::PTP Parameters::Base Comms::PTP	NONE	0:NONE 1:INITIALISNG 2:FAULTY 3:DISABLED 4:LISTENING 5:PRE-MASTER 6:MASTER 7:PASSIVE 8:UNCALIBRATED 9:SLAVE		NEVER

PTP parameter.

A diagnostic parameter indicating the state of the internal PTP state machine.

Enumerated values:

0: NONE	the PTP module is disabled or the Ethernet cables are removed
1: INITIALISNG	the PTP is initialising the data sets and communications
2: FAULTY	the PTP module failed to initialise
3: DISABLED	the PTP will not send any messages and will accept only PTP management messages
4: LISTENING	the PTP is listening for Announce messages from a master or waiting to timeout on received announce messages.
5: PRE-MASTER	the PTP behaves as though it were in the MASTER state but will not send any messages except for peer delay, signalling or management messages.
6: MASTER	the PTP is behaving as a master
7: PASSIVE	the PTP will not send any messages except for peer delay, signalling or management messages
8: UNCALIBRATED	the PTP is in a transient state. One or more master ports have been detected in the domain. The appropriate master port has been selected, and the local port is preparing to synchronize to the selected master port.
9: SLAVE	the PTP is synchronizing or synchronized to a master

8-26 Ethernet

Parameter Name	No.	Path	Default	Range	Units	Writable
PTP Clock	1699	Monitor::Communications::PTP Parameters::Base Comms::PTP	1970/01/01 00:00:00	-		NEVER
<p>PTP parameter. Diagnostic parameter giving the current value of the PTP clock to 1 second accuracy. Note this is not intended to represent the actual date and time.</p>						
PTP Offset	1687	Monitor::Communications::PTP Parameters::Base Comms::PTP	0 ns	-2000000000 to 2000000000		NEVER
<p>PTP parameter. Diagnostic parameter giving the average offset in nanoseconds between the PTP clock and the master clock.</p>						
PTP Locked	1688	Monitor::Communications::PTP Parameters::Base Comms::PTP	FALSE	FALSE TRUE		NEVER
<p>PTP parameter. Diagnostic parameter indicating when the inverter is a slave that the PTP clock has synchronised to a master clock determined by parameter 1685 PTP Locked Threshold. If the inverter is a master then this parameter will be set to TRUE.</p>						

Peer to Peer

The Peer to Peer module is implemented in the AC30P and AC30D inverters and provides Ethernet communications between inverters.

The data sent is not accessible to the user. The initial use of the Peer to Peer module is for shaft locking applications using the Virtual Master or Real Master control and used in conjunction with the Precision Time Protocol (PTP).

Note: The Peer to Peer module broadcasts data at a high rate, as such, when the Peer to Peer module is enabled it is recommended not to connect the inverters to a corporate or other sensitive network.

Configuration

To enable the Peer to Peer module set the parameter **1725 Peer to Peer Enable** to TRUE on all inverters participating. For most applications the default settings may be used.

An inverter would be configured as a master (sending data) or a slave (receiving data). It is also possible that an inverter may be both a master and a slave.

Typical configurations would be:

- Unicast – a master sends to a single slave. The master sends data to the host IP address of the slave.
- Broadcast – a master sends to all slaves. The master sends data using the broadcast IP address of 255.255.255.255
- Multicast – a master sends to a group of slaves. The master sends data using a multicast IP address. The range of 239.0.0.0 to 239.255.255.255 is permitted. Slaves must join the group to listen to a particular master sending multicast data.

For further information about configuring the module see the section *Peer to Peer Parameter Summary*.

8-28 Ethernet

Example Configurations

Unicast – inverter 1 is a master to inverter 2

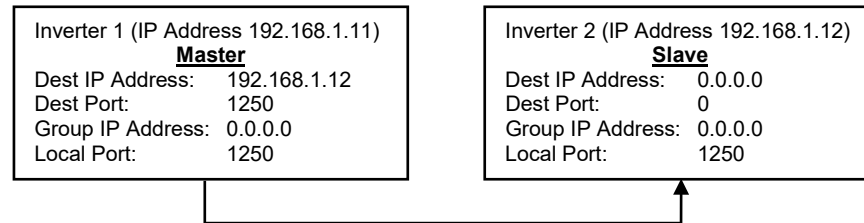

Broadcast - inverter 1 is a master to inverters 2 and 3 (note that this could also be done as a multicast)

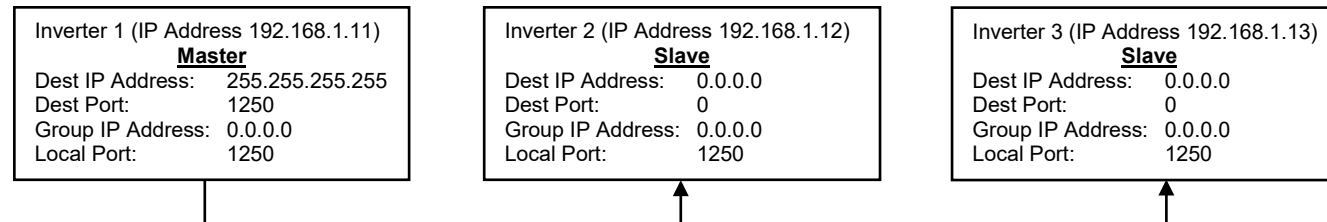

Multicast – inverter 1 is a master to inverter 2 and 3, also inverter 3 is a master to inverters 4 and 5

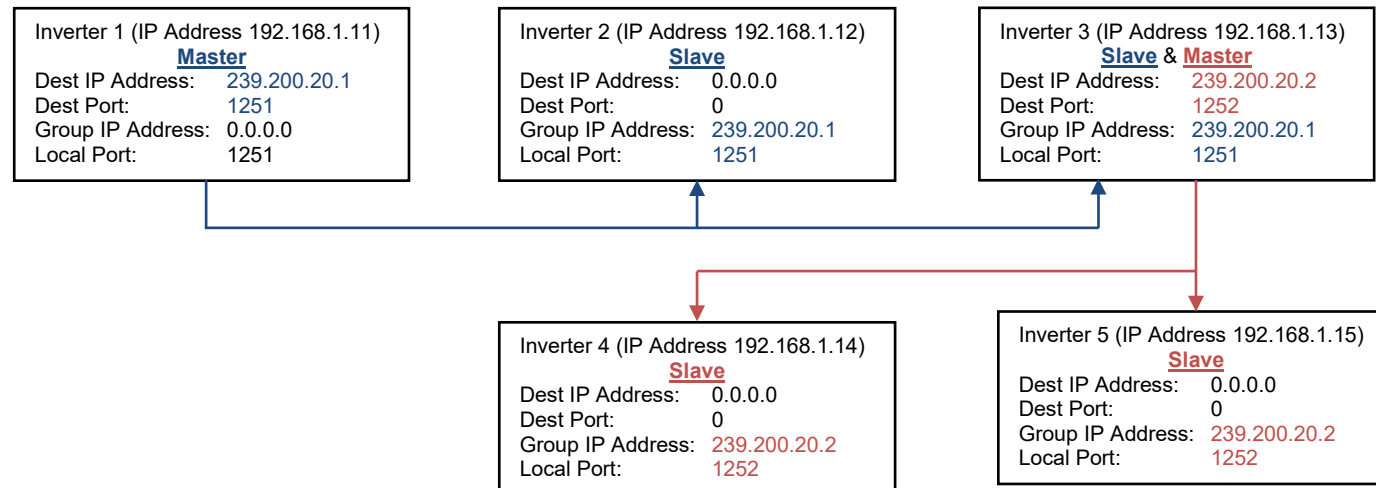

Peer to Peer Parameter Summary

Note: The value of the Peer to Peer configuration parameters only become active when the Peer to Peer module initialises, i.e. on inverter power-up or transition of the parameter 1725 Peer to Peer Enable to TRUE.

Parameter Name	No.	Path	Default	Range	Units	Writable
Peer to Peer Enable	1725	Setup::Communications::Peer to Peer Parameters::Base Comms::Peer to Peer	FALSE	FALSE TRUE		ALWAYS
Peer to Peer Parameter. Enables the Peer to Peer module.						
Destination IP Address	1726	Setup::Communications::Peer to Peer Parameters::Base Comms::Peer to Peer	255.255.255.255	0.0.0.0 to 255.255.255.255		ALWAYS
Peer to Peer Parameter. Sets the destination IP address of the data when the Peer to Peer module is sending as a master. If the inverter is not sending data then this may be set to 0.0.0.0						
<ul style="list-style-type: none"> • If the Destination IP Address is set to a unicast address then the sent data is only received by the slave inverter that has this IP address. • If the Destination IP Address is set to 255.255.255.255 then the sent data is broadcast and all slave inverters will receive the data. • If the Destination IP address is set to 239.x.x.x then the data is sent as a multicast and all slave inverters listening to this multicast address will receive the data. See Group IP Address below. 						
Destination Port	1727	Setup::Communications::Peer to Peer Parameters::Base Comms::Peer to Peer	1250	0 to 65535		ALWAYS
Peer to Peer Parameter. Sets the UDP port number the Peer to Peer module sends data to. This will be set the same as the Local Port receiving the data. If the inverter is not sending data then this may be set to zero.						

8-30 Ethernet

Parameter Name	No.	Path	Default	Range	Units	Writable
Group IP Address	0114	Setup::Communications::Peer to Peer Parameters::Base Comms::Peer to Peer	0.0.0.0	0.0.0.0 to 255.255.255.255		ALWAYS
<p>Peer to Peer Parameter.</p> <p>Sets the group (multicast) IP address to join. The inverter will accept multicast data sent by a master to this multicast IP address. Only the multicast IP address range 239.x.x.x is permitted. If the inverter is receiving unicast or multicast data then this parameter should be set to its default of 0.0.0.0</p>						
Local Port	1728	Setup::Communications::Peer to Peer Parameters::Base Comms::Peer to Peer	1250	1 to 65535		ALWAYS
<p>Peer to Peer Parameter.</p> <p>Sets the UDP port number the Peer to Peer module receives the data on. This will be set to the same value as the Destination Port of the master sending the data. If the inverter is a master only and not receiving data then this may be set to the same value as its own Destination Port.</p>						
Peer to Peer State	1729	Monitor::Communications::Peer to Peer Parameters::Base Comms::Peer to Peer	DISABLED	DISABLED ACTIVE ERROR		NEVER
<p>Peer to Peer Parameter.</p> <p>A diagnostic parameter indicating the state of the Peer to Peer module.</p> <p>Enumerated values:</p> <p>0: DISABLED - the Peer to Peer module is disabled.</p> <hr/> <p>1: ACTIVE - the Peer to Peer module is enabled and ready for communications.</p> <hr/> <p>2: ERROR - the Peer to Peer module is in an error state and communications could not be established.</p>						

Chapter 9: Fire Mode



Caution

When Fire Mode is active the Drive and Motor protection trips are disabled. The use of Fire Mode itself increases the risk of causing a fire by overloading the drive or motor, so it must only be used after assessing the risks.

Intended Use

Fire mode is intended for use in critical situations where it is imperative for the motor to be kept running if at all possible. In such a situation it may be reasonable to override the drive's normal protective functions. An example of a critical situation may be a ventilation fan in a stairwell, where continued operation in the event of a fire may assist the safe evacuation of personnel.

Summary

When Fire Mode is enabled the drive firmware attempts to keep the drive running wherever possible. If the drive was running when Fire Mode was activated it will continue to run. If the drive was stopped when Fire Mode was activated then the Fire Mode firmware will attempt to start it. While Fire Mode is enabled the majority of trips will be ignored, (possibly leading to damage to the drive, motor or attached equipment). If one of the remaining enabled trips does occur then the Fire Mode firmware will wait until the trip source has become inactive and will then restart the drive.

When Fire Mode is deactivated the drive will return to its previous sequencing mode. If the drive was running in Local mode the motor will be stopped. If the drive was running in remote terminals or remote communications mode the drive will continue running according to the relevant control word, (refer to Appendix B).

9-2 Fire Mode

Configuration

The parameters used to configure Fire Mode are detailed in Appendix C. This description is partially duplicated here for convenience.

PNO* Parameter Descriptions

Activate

A Boolean input. Set to TRUE to enable Fire Mode according to the Fire Mode parameter. This input parameter may only be set by connection to a digital input.

Default value FALSE

1961*

Setpoint

A reference value to be used when Fire Mode is active. Setting a negative setpoint will cause the drive to rotate in reverse direction.

Default value 0.0%. Range -100% to 100%

1962*

Level

An enumerated input parameter. Selects the mode of operation when Fire Mode is enabled

0. DISABLED

1. PARTIAL

2. FULL

Default value is DISABLED.

1963*

Restart Delay

Specifies the time to wait before attempting to reset a trip.

1964*

Activated

A Boolean output that indicates when Fire Mode is active. This is TRUE when **Level** is either PARTIAL or FULL, the **Setpoint** is not 0.0% and **Activate** is TRUE.

1965*

Ready

A Boolean output that indicates when Fire Mode will be activated if **Activate** is set TRUE. This is TRUE when **Level** is either PARTIAL or FULL and the **Setpoint** is not 0.0%.

1966*

Last Activated

A Data and Time output parameter that records the last time that the fire mode became active. This may be used to validate that the fire mode has been tested. This value is recorded in non-volatile memory. The value will be reset if an application is loaded that does not implement Fire Mode.

1967*

Activation Count

An integer output parameter that records the number of times the fire mode has become active. This value is saved in non-volatile memory. The activation count will be reset if an application is loaded that does not implement Fire Mode.

* These PNO values are correct for the Fan Application. Custom configurations may assign the Fire Mode parameter to different PNOs.

Functional Description

When Fire Mode is enabled the normal speed reference and start / stop control of the drive are modified.

Sequencing

Sequencing is the term given to controlling when the drive runs. When Fire Mode is enabled the normal sequencing control signals are overridden. The parameters that control this are

	Activate
	Setpoint
	Level
PNO 0610	Sequencing::App Control Word bit 0, Switch On, (refer to Appendix B:Sequencing Logic). In typical applications bit 0 of the App Control Word is driven from a digital input, used as a Coast Stop signal.

If **Level** is set to DISABLED or **Setpoint** is zero then setting **Activate** to TRUE will have no effect.

If **Level** is set to either PARTIAL or FULL and **Setpoint** is not zero then setting **Activate** to TRUE will activate Fire Mode. When Fire Mode is active the drive will run, (turn the motor).

The only reasons that the drive will not run are:

- **Level** is changed back to DISABLED
- **Activate** is changed back to FALSE
- **Setpoint** is change to zero
- The Coast Stop input is activated.
- The STO circuit is activated.
- An enabled trip source becomes active.
- A hardware fault

Reference

The Fire Mode **Setpoint** parameter is selected automatically whenever Fire Mode is **Activated**. The Setpoint is passed through the System Ramp, (see Appendix D).



Caution Fire Mode does not override the standard Ramp features. Specifically **0497 Ramp Hold** can prevent the setpoint changing to the Fire Mode **Setpoint** value.

9-4 Fire Mode

Trips and Auto Restart

The following table summarizes which trips are disabled in the two modes of operation. Also shown are those trips which are designed to protect the drive.



Caution Disabling the Drive Protection trips will invalidate the drive's warranty. Selecting PARTIAL mode leaves the drive protection features enabled. Selecting FULL mode disables some of the drive protection features.



Caution Regardless of the setting of **Level**, activating Fire Mode may cause damage to the motor or attached equipment.

ID	Trip Name	Disabled in Partial mode	Disabled in Full mode	Drive Protection
1	OVER VOLTAGE			✓
2	UNDER VOLTAGE ⁽¹⁾	Note 1	Note 1	
3	OVER CURRENT			✓
4	STACK FAULT			✓
5	STACK OVER CURRENT			✓
6	CURRENT LIMIT	✓	✓	
7	MOTOR STALL	✓	✓	
8	INVERSE TIME		✓	✓
9	MOTOR I2T	✓	✓	
10	LOW SPEED I	✓	✓	
11	HEATSINK OVERTEMP		✓	✓
12	AMBIENT OVERTEMP		✓	✓
13	MOTOR OVERTEMP	✓	✓	
14	EXTERNAL TRIP	✓	✓	
15	BRAKE SHORT CCT		✓	✓
16	BRAKE RESISTOR	✓	✓	
17	BRAKE SWITCH		✓	✓
18	LOCAL CONTROL	✓	✓	
19	COMMS BREAK	✓	✓	
20	LINE CONTACTOR	✓	✓	
21	PHASE FAIL	✓	✓	
22	VDC RIPPLE		✓	✓
23	BASE MODBUS BREAK	✓	✓	
24	24V OVERLOAD	✓	✓	
25	PMAC SPEED ERROR	✓	✓	

ID	Trip Name	Disabled in Partial mode	Disabled in Full mode	Drive Protection
26	OVERSPEED	✓	✓	
27	SAFE TORQUE OFF	✓	✓	
28	FEEDBACK MISSING	✓	✓	
29	INTERNAL FAN FAIL	✓	✓	
30	CURRENT SENSOR	✓	✓	
31	POWER LOSS STOP	✓	✓	
32	SPEED SENSOR FAULT	✓	✓	
33	A1	✓	✓	
34	A2	✓	✓	
35	A3	✓	✓	
36	A4	✓	✓	
37	A5	✓	✓	
38	A6	✓	✓	
39	A7	✓	✓	
40	A8	✓	✓	
41	SPEED ERROR FAULT	✓	✓	
42	PEER TO PEER OVERRUN	✓	✓	
43	PHASE CONFIG	✓	✓	
44	ETHERNET IP BREAK	✓	✓	
45	RESOLVER ERROR	✓	✓	
46	PMAC ALIGN ERROR	✓	✓	
47	CURRENT IMBALANCE	✓	✓	
48	CONFIGURATION	✓	✓	

Note 1. The Under Voltage trip is enabled when Fire Mode is active, but the trip level is reduced by 50%.

If a trip source becomes active when the associated trip is disabled the drive will continue to run. This is also the normal behavior of the drive, (when Fire Mode is not active). If the associated trip is designed for drive protection, this will be recorded in non-volatile memory. The recorded values are available to view in the Trips History parameter block, (refer to Appendix C).

When Fire Mode is activated and a trip source becomes active and the associated trip is enabled, the drive will trip, causing the motor to stop. This is similar to the normal behavior of the drive, (when Fire Mode is not active). However, when Fire Mode is active the drive firmware continues to monitor the trip source, once the trip source has become inactive the drive automatically resets the trip condition and restarts the drive.

The Fly catching feature can be used to allow the drive to smoothly resume control of a moving load on restart.

The operation of Fire Mode is independent of the motor type motor and the control mode, (Open Loop or Sensorless Vector control).

9-6 Fire Mode

Appendix A: Fieldbuses

Modbus TCP

Introduction

The inverters built-in Ethernet includes a Modbus TCP server. The Modbus registers are mapped to the inverters parameters. Up to 3 simultaneous connections to Modbus clients are possible. TCP port 502 is used.

Making a connection to the Ethernet and setting an IP address on the inverter is described in Chapter 12 (Ethernet). If the Modbus TCP is used as part of a process control it is recommended a dedicated network be used with fixed IP addresses for the inverter.

To allow Modbus TCP connections to the inverter, the parameter **0939 Maximum Connections** must be set to a value greater than zero.

Modbus Register Mapping Summary

The inverter parameters are mapped to the Holding Registers and Input Registers, either as a fixed mapping or as a user-defined mapping. There is no mapping to Coils or Discrete Inputs.

Holding Register Address	Input Register Address	Description
00001 - 00256	00001 - 00256	User-defined mapping to the inverter parameter values.
00257 - 00528	00257 - 00528	Reserved area. Do not write into this register range.
00529 - onwards	00529 - onwards	Fixed mapping to the inverter parameter values.

A-2 Fieldbuses

Fixed Parameter Mapping

Each parameter number is mapped onto **two** consecutive Modbus registers regardless of the parameter data type. The relationship between the Holding Register or Input Register is given as:

$$\text{Register number} = (\text{parameter number} - 1) * 2 + 529$$

- If the parameter has a data type that uses one byte then it will occupy the low byte of the first register and the high byte will be zero, i.e. the register will not be sign extended.
- If the parameter has a data type that uses two bytes then it will occupy the first register.
- Unused register locations will read zero; writing to that location will have no effect.
- The word order of 32-bit parameters is determined by the inverter parameter **0940 High Word First**.
- Writable 32-bit parameters will only accept a change in value if *both* registers mapped to the parameter are written to in the same request.

Fixed Parameter Mapping - Arrays

Some parameters have multiple elements and are classified as parameter arrays. A parameter array has a parameter number that represents the *whole* of the array, but also has parameter numbers that represent each *element* of the array. An example is given below.

Array Example

A parameter array called **Recent Trips** has 10 elements.

Parameter Number	Parameter – Recent Trips
895	Whole array
896	index 0
897	index 1
...	...
905	index 9

If the parameter number of the whole array is 895, then the parameter number of the element index 0 of the array will be 896, the parameter number of the element index 1 will be 897, etc.

Note: *String* array parameters access their elements via parameter numbers that are calculated in a different way (see [Fixed Parameter Mapping - Strings](#)).

Accessing the parameter arrays via the parameter number that represents the whole array is not recommended. This will access only the first four bytes (2 registers) of the array. The array should rather be accessed via its elements.

Fixed Parameter Mapping - Strings

Strings parameters have a parameter number that represents the whole string. This parameter number is mapped to two registers so limits access to the first four characters. Additional contiguous parameter numbers are set aside so that the whole string can be accessed: one additional parameter number for each four characters. The strings are packed into the registers **low byte first**.

String Example

A string parameter called **My String** has a string length of 12 characters (plus the null terminator). This will have one parameter number allocated for the whole string (in this example 161) and 3 further parameter numbers for the string fragments (162-164).

If the value of the string is "0123456789AB":

Parameter Number	Represents	Register Number	Register Value	
			hi-byte	lo-byte
0161	whole string "0123456789AB"	00849	'1'	'0'
		00850	'3'	'2'
0162	Fragment "0123"	00851	'1'	'0'
		00852	'3'	'2'
0163	fragment "4567"	00853	'5'	'4'
		00854	'7'	'6'
0164	fragment "89AB"	00855	'9'	'8'
		00856	'B'	'A'

Note: This is example is not a real parameter.

As each inverter parameter maps to two registers, if the registers that represent the whole string are accessed then only the first four characters will appear. To access the whole string over Modbus use the registers that map to the parameter number of the whole array plus one, in this example **0162** (register **00851**). A multiple read or write of registers will then provide access to the whole string.

A-4 Fieldbuses

String Array Example

A string array parameter called **My String Array** has 2 elements of string length 5 characters (plus the null terminator) each. In this example the parameter number of the whole array is 175.

If the values of the array elements are "12345" and "abc":

Parameter Number	Represents		Register Number	Register Value	
				hi-byte	lo-byte
0175	whole array ["12345", "abc"]		00877	'2'	'1'
			00878	'4'	'3'
0176	1 st element "12345"		00879	'2'	'1'
			00880	'4'	'3'
0177	fragment "1234"		00881	'2'	'1'
			00882	'4'	'3'
0178	fragment "5"		00883	<i>null</i>	'5'
			00884	<i>undefined</i>	<i>undefined</i>
0179	2 nd element "abc"		00885	'b'	'a'
			00886	<i>null</i>	'c'
0180	fragment "abc"		00887	'b'	'a'
			00888	<i>null</i>	'c'
0181	fragment ""		00889	<i>undefined</i>	<i>undefined</i>
			00890	<i>undefined</i>	<i>undefined</i>

Note: This example is not a real parameter.

To access the first element of the array over Modbus then parameter number **0177** (register **00881**) would be used. To access the second element then parameter number **0180** (register **00887**) would be used.

User-Defined Parameter Mapping

The inverter parameters may be mapped to the user-defined register area (00001 – 00256). This allows parameters to be grouped together so that they may be accessed through a single Modbus request.

To map parameters add the required parameter numbers to the user mapping table using parameter **1567 Modbus Mapping**. The following applies:

- The mapping starts at register 00001.
- Any valid fixed or application parameter may be added excluding password parameters and parameter arrays - individual elements of the array may be added however.
- Parameter strings may be added.
- The mapping ends on the first mapping entry of zero or when the mapping table is full.

Note: The mapping may be modified at any time. However no Modbus requests should be made when the mapping is being modified to avoid indeterminate response data.

Unlike the fixed mapping, the user-defined parameter mapping will only use as many registers as necessary to accommodate the parameter. An example is given below:

Mapping Table	Parameter Name	Data Type	No. of Registers	Start Register	End Register
0	0627 Comms Control Word	WORD	1	00001	00001
1	0681 Comms Reference	REAL	2	00002	00003
2	0696 First Trip	USINT	1	00004	00004
3	0661 Status Word	WORD	1	00005	00005
4	0395 Actual Speed Percent	REAL	2	00006	00007
5	0961 Drive Name	23-character STRING	12	00008	00019
6	0000				

The mapping table is continually checked for valid entries. The diagnostic parameter **1632 Mapping Valid** will be TRUE if all entries in the table are valid parameters. If the diagnostic parameter is FALSE, meaning there are invalid entries, then Modbus requests are still accepted but the invalid entries will be skipped over and will occupy no registers in the mapping.

A-6 Fieldbuses

The following applies to user-mapped parameters:

- If the parameter has a data type that uses one byte then it will occupy the low byte of the Modbus register and the high byte will be zero, i.e. the register will not be sign extended.
- The word order of 32-bit parameters is determined by the inverter parameter **0940 High Word First**.
- Writable 32-bit parameters will only accept a change in value if *both* registers mapped to the parameter are written to in the same request.
- String parameters are packed into the registers **low byte first**.
- Writable string parameters will only accept a change if the first register is included in the request. If the string is not null terminated, then a null termination will be added automatically.

Password Protection

Write access to parameters via the fixed mapping registers may be restricted by setting the parameter **1659 Modbus TCP Password**.

Note that there is no restriction to parameters via the user-defined mapping registers.

When this password is set to a value other than zero, writing to parameters will only be possible when the password is unlocked. If the password is not unlocked then writes will be ignored.

To unlock the password write to the Modbus register **00518** the value set in the parameter 1659 Modbus TCP Password. Write access will be available until a subsequent write to the Modbus register 00518 of value 0000.

Note the following:

- A read of Modbus register 00518 will always respond with a value of 0000 regardless of the password being locked or unlocked.
- Locking and unlocking the password will apply to all Modbus connections.
- When all Modbus connections are closed, write access will returned back to the locked state if a password is set.

Supported Modbus Functions

Four Modbus functions are supported:

Read Holding Registers (#3)

This function allows multiple Input registers to be read. Up to 125 registers may be read. As the Holding registers and Input registers map to the same inverter parameters this will return the same values as the Read Input Registers function.

Read Input Registers (#4)

This function allows multiple Holding registers to be read. Up to 125 registers may be read. As the Holding registers and Input registers map to the same inverter parameters this will return the same values as the Read Holding Registers function.

Write Single Register (#6)

This function allows a single Holding register to be written to. Note that this function may only be used on registers that map to 1-byte or 2-byte inverter parameters. An attempt to write to a register that maps to a 4-byte parameter will have no effect on the parameter.

Write Multiple Registers (#16)

This function allows a contiguous block of Holding registers to be written to. Up to 120 registers may be written. Note that when writing to registers that map to 4-byte inverter parameters both registers must be written to. Writing to one-half of a 4-byte parameter will have no effect on the parameter.

A-8 Fieldbuses

Modbus Exception Codes

Three Modbus exception codes are supported:

Illegal Function (01)

The Modbus function is not supported by the slave.

Illegal Data Address (02)

If the register data address contained in the Modbus request maps to an inverter parameter that is outside the range of parameter numbers then this exception will occur.

Illegal Data Value (03)

If the number of bytes or words contained in the Modbus request field is out of range then this exception will occur.

Process Active and Lost Communications Trip

Process Active Flag

The Process Active flag is represented by the inverter parameter **0943 Process Active**. This parameter changes to TRUE on the first valid Modbus request.

If the parameter **0941 Modbus Timeout** is set to a non-zero value then the **Process Active** parameter will subsequently change to FALSE if a Modbus request is not received within the timeout period.

Trip

If enabled, a break in the Modbus communications can be used to generate a trip. The **0943 Process Active** parameter is used to generate the trip. If this parameter transitions from TRUE to FALSE then a trip will event will be generated.

To enable the base communications Modbus trip, the parameter **0942 Modbus Trip Enable** must be set to TRUE *and* the **BASE MODBUS BREAK** bit set in the parameter **0697 Enable 1-32**. The parameter **0941 Modbus Timeout** must be set to a value other than zero.

For information on enabling trips see Chapter 10 Trips & Fault Finding.

Connection Timeout

The parameter **1241 Open Connections** indicates the number of open connections to the inverter Modbus TCP server.

A connection receive timeout may be set using the parameter **1458 Modbus Conn Timeout**. If this is set to a value other than zero, then the connection will be closed by the server if no data has been received within the timeout period. This is useful, for example, if the link between the server and client is lost, otherwise the connection may remain open indefinitely.

Parameter Summary

The following parameters are relevant to the Modbus TCP.

Parameter Name	No.	Path	Default	Range	Writable
Maximum Connections	0939	Setup::Communications::Base Modbus Parameters::Base Comms::Modbus	*	0 - 3	ALWAYS
<p>Modbus TCP parameter.</p> <p>Sets the maximum number of Modbus clients allowed. If set to zero, then no connections will be allowed.</p> <p>* The default value is set to the value of Open Connections, PNO1241. This is typically 0.</p>					
High Word First	0940	Setup::Communications::Base Modbus Parameters::Base Comms::Modbus	FALSE	FALSE TRUE	ALWAYS
<p>Modbus TCP parameter.</p> <p>If set to TRUE, the most significant word of a 32-bit parameter will be mapped to the first register, and the least significant word to the next register.</p>					
Modbus Timeout	0941	Setup::Communications::Base Modbus Parameters::Base Comms::Modbus	3.0 seconds	0.0 – 65.0 seconds	ALWAYS
<p>Modbus TCP parameter.</p> <p>Sets the process active timeout.</p>					
Modbus Trip Enable	0942	Setup::Communications::Base Modbus Parameters::Base Comms::Modbus	TRUE	FALSE TRUE	ALWAYS
<p>Modbus TCP parameter.</p> <p>Set TRUE to enable the Modbus Trip. The parameter Modbus Timeout must be set to a value other than zero</p>					
Open Connections	1241	Monitor::Communications::Base Modbus Parameters::Base Comms::Modbus	0	0 - 3	NEVER
<p>Modbus TCP parameter.</p> <p>Indicates the number of open connections to the inverter Modbus TCP server.</p>					
Process Active	0943	Monitor::Communications::Base Modbus Parameters::Base Comms::Modbus	FALSE	FALSE TRUE	NEVER
<p>Modbus TCP parameter.</p> <p>Indicates that a Modbus request addressed to this node has been received within the period set by the parameter Modbus Timeout, or if no timeout is specified, this parameter will stay active after the first received Modbus request.</p>					

A-10 Fieldbuses

Parameter Name	No.	Path	Default	Range	Writable
Modbus Conn Timeout	1458	Setup::Communications::Base Modbus Parameters::Base Comms::Modbus	66 seconds	0 – 100,000 seconds	ALWAYS
<p>Modbus TCP parameter.</p> <p>Sets the Modbus connection timeout. If this parameter is set to zero then the connection will not timeout.</p>					
Modbus Mapping	1567	Setup::Communications::Base Modbus Parameters::Base Comms::Modbus	<i>none</i>	0 Last parameter number	ALWAYS
<p>Modbus TCP parameter.</p> <p>User-defined Modbus parameter mapping table. Each entry in the table represents the required parameter number.</p>					
Mapping Valid	1632	Monitor::Communications::Base Modbus Parameters::Base Comms::Modbus	TRUE	FALSE TRUE	NEVER
<p>Modbus TCP parameter.</p> <p>Status of the user defined mapping area. This will be set to TRUE if all entries in the mapping table are valid.</p>					
Modbus TCP Password	1659	Setup::Communications::Base Modbus Parameters::Base Comms::Modbus	0000	0000 FFFF	ALWAYS
<p>Modbus TCP parameter.</p> <p>Modbus password. When set to a value other than zero, write access to parameters via the fixed mapping registers will be restricted. To unlock the password, write to the Modbus register 00518 the value set in this password. A subsequent write of value 0000 to Modbus register 00518 will lock the password.</p>					

EtherNet/IP Adapter

Introduction

The built-in EtherNet/IP adapter (slave/server) is implemented in the AC30P and AC30D inverters.

To make use of this feature, firmware version V3.x.x needs to be installed in the inverter. The firmware may be updated by downloading the firmware file from the Parker website (see section *Firmware Update* in Chapter 4) or installed from the latest version of PDQ. With version V3.x.x firmware installed, the **AC30EIPS** CoDeSys (PDQ/PDD) device is required.

Note: V3.x.x firmware has no AFE support and an application size of 128Kbytes (rather than 192Kbytes).

Features

The following EtherNet/IP features are implemented:

- Class 1 and Class 3 connections
- One input assembly instance of up to 500 bytes
- One output assembly instance of up to 496 bytes
- Input mapping of up to 32 inverter parameters
- Output mapping of up to 32 inverter parameters
- Unicast or multicast communications
- Requested Packet Interval (RPI) down to 2ms
- Explicit access of inverter parameters (read and write)

Identity

The EtherNet/IP adapter has the following identity:

Vendor ID **4** (Parker-Hannifin)

Product Code **306** (Parker AC30 Drive)

A-12 Fieldbuses

Inverter Configuration

Enabling

To enable the EtherNet/IP adapter set the parameter **3128 EtherNet IP Enable** to TRUE.

The current state of the EtherNet/IP adapter is given by the parameter **3130 EtherNet IP State**.

Note the EtherNet/IP adapter is only active when the inverter is in the Operational state.

IP Settings

The IP settings are set up from the inverter using the Ethernet parameters described in Chapter 12. The IP settings of the inverter cannot be set via the PLC.

The current IP settings are monitored using the parameters:

0926 IP Address

0927 Subnet Mask

0928 Gateway Address

If parameter **0929 DHCP** is set to TRUE, then the IP address will be set from the DHCP server on the network, if one is available.

If parameter **0930 Auto IP** is set to TRUE, then the IP address will be automatically be assigned a link-local address.

If both parameters **0929 DHCP** and **0930 Auto IP** are FALSE, then the IP address, subnet mask and gateway address will be set from the values in the parameters:

0933 User IP Address

0934 User Subnet Mask

0935 User Gateway Address

Parameter Mapping

The input and output assembly mappings of the inverter parameters are set in the parameters **3000 Input Mapping** (PLC->inverter) and **3064 Output Mapping** (inverter->PLC). Parameters created in the application may be added into the mapping. The mapping of each table ends on the first zero entry.

The total number of input and output bytes mapped depends on the type of parameters added to the mapping tables. The number of bytes used by each data type is summarized in the table.

AC30 Data Type	Bytes
BOOL	1
SINT	1
INT	2
DINT	4
USINT (incl enumerated)	1
UINT	2
UDINT	4
REAL	4
TIME	4
DATE	4
TIME_OF_DAY	4
DATE_AND_TIME	4
BYTE	1
WORD	2
DWORD	4

For the **input mapping** each parameter must be read-writable. Parameter arrays are permitted. Configuration type parameters, string parameters, password parameters and reserved parameters are not permitted. The default input mapping is given in the table.

Input Mapping Table		Data Type	Bytes
000	0627 Comms Control Word	WORD	2
001	0681 Comms Reference	REAL	4
002	0000		

For the **output mapping** each parameter may be read-only or read-writable. Parameter arrays are permitted. String parameters and password parameters are not permitted. The default output mapping is given in the table.

Output Mapping Table		Data Type	Bytes
000	0661 Status Word	WORD	2
001	0395 Actual Speed Percent	REAL	4
002	0000		

If the input and output mappings have invalid entries then the parameter **3130 EtherNet IP State** will report **ERROR** and the inverter will not go into the Operational state.

A-14 Fieldbuses

Assembly Instances

The assembly instance numbers are:

Assembly Instance	Number
Input (T2O)	100
Output (O2T)	150
Input only	198
Listen Only	199

Electronic Data Sheet (EDS) File

The latest EtherNet/IP EDS file for the inverter may be downloaded from www.parker.com

The EDS file may also be downloaded directly from the drive via a web browser. To access this make sure the parameter **0944 Web Access** is set to LIMITED or FULL.

Enter the inverter IP address into the web browser and access the web page “**Services**” and under **EtherNet/IP EDS file** click the Download button. Alternatively type the following into the browser address bar (replacing **ip_address** with the inverter’s IP address):
ip_address/eds/eips.zip

Example PLC Configurations

Using RSLogix 5000

The example in this section uses the default parameter mapping of the inverter described under Parameter Mapping in the Inverter Configuration section above:

Input Mapping Table		Data Type	Bytes
000	0627 Comms Control Word	WORD	2
001	0681 Comms Reference	REAL	4
002	0000		

Output Mapping Table		Data Type	Bytes
000	0661 Status Word	WORD	2
001	0395 Actual Speed Percent	REAL	4
002	0000		

A CompactLogix L32E controller is used.

1. Start a new project from within RSLogix 5000 and select the required controller.

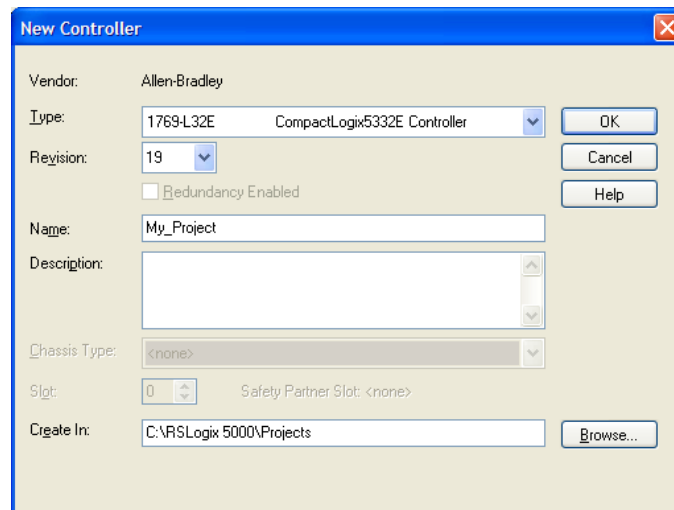

A-16 Fieldbuses

2. Open the **Ethernet Port** properties and enter the IP address of the Controller.

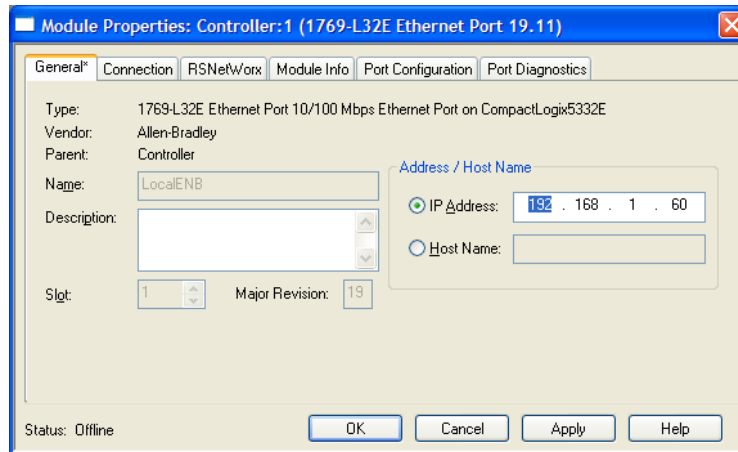

3. Right-click on the **Ethernet Port** and select **New Module**. Under **Communications** select the **Generic Ethernet Module**.

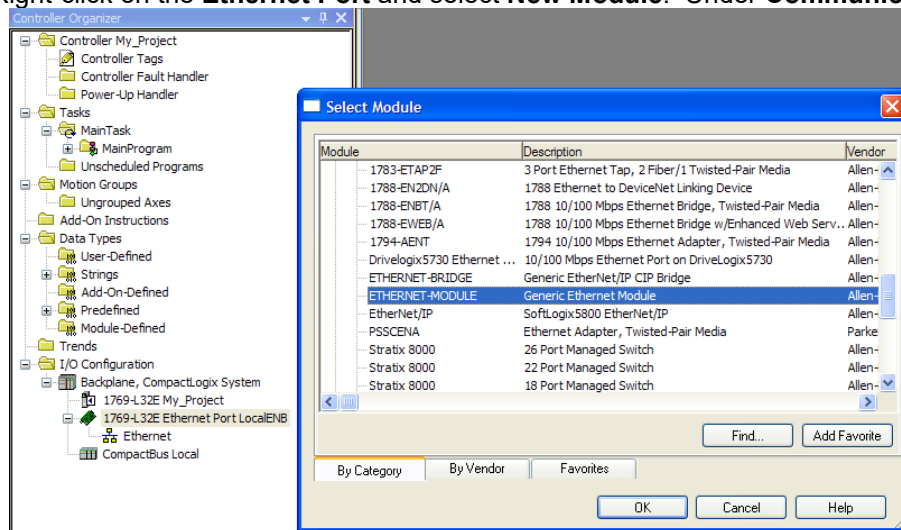

- Enter the Name and IP address of the inverter. Set the **Comm Format** as **Data – SINT**. The **Input Assembly Instance** is **100** and in this example the data size is a total of 6 bytes. The **Output Assembly Instance** is **150** and in this example the data size is a total of 6 bytes. The mapping sizes on the inverter **MUST** match that on the PLC. Set the Configuration Assembly Instance to 128 size 0.

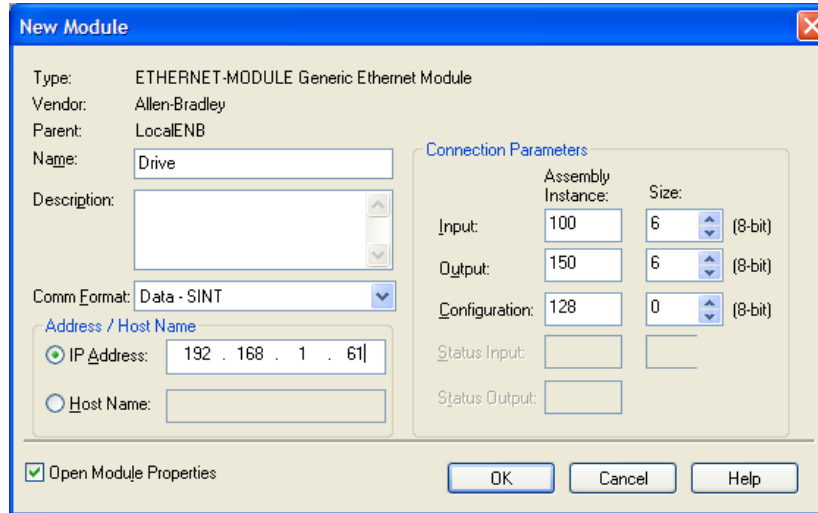

- Within the **Controller Tags** the communications data arrays are automatically created:

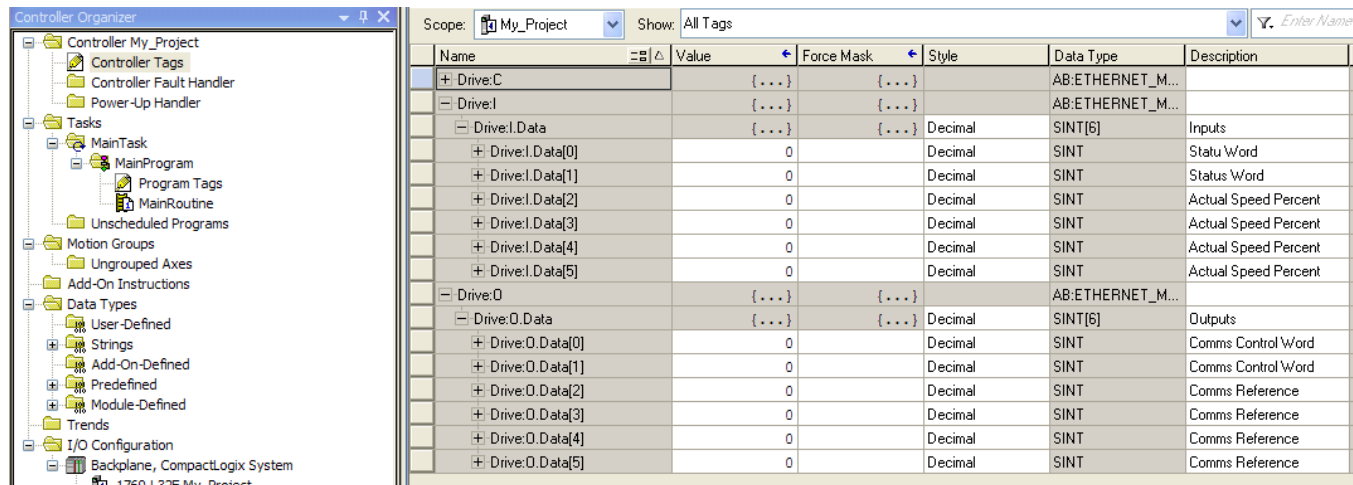

A-18 Fieldbuses

6. Additional tags can be created to represent the actual data on the AC30.

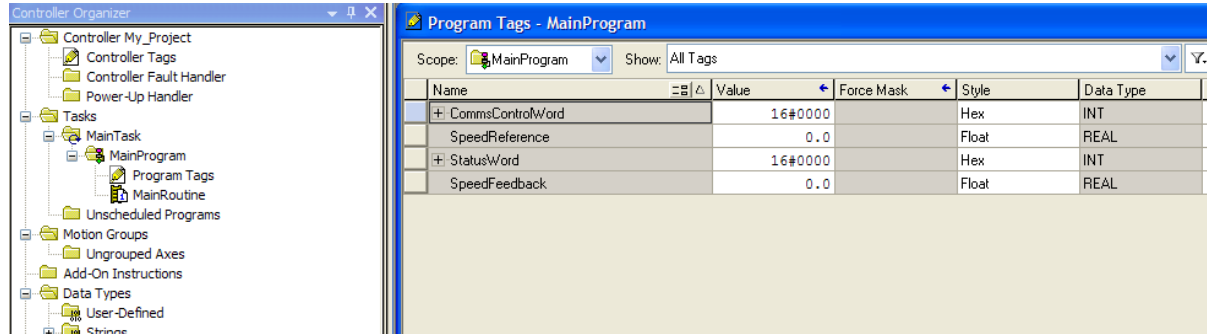

7. The data can be transferred between the communication data arrays and the program data using the Synchronous Copy File (CPS) copy instruction as shown in the ladder diagram. Note that the CPS function is not interrupted until the copy is done.

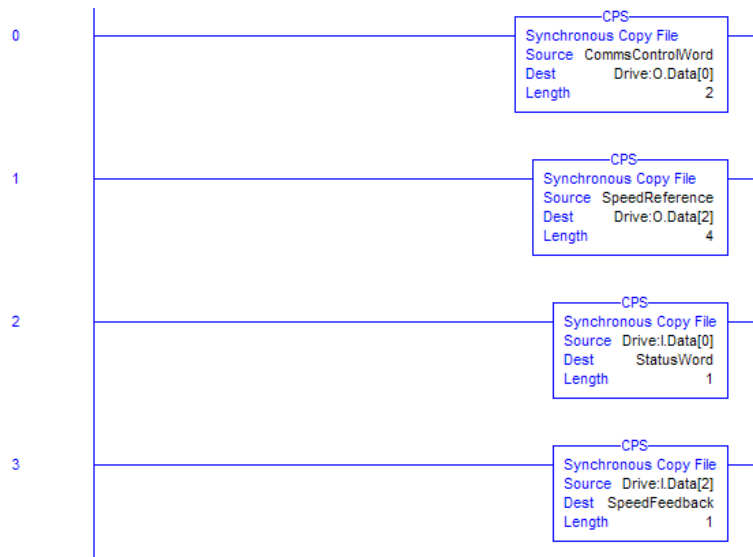

Using a CoDeSys Based PLC

The example in this section uses the default parameter mapping of the inverter described under Parameter Mapping in the Inverter Configuration section above:

Input Mapping Table		Data Type	Bytes
000	0627 Comms Control Word	WORD	2
001	0681 Comms Reference	REAL	4
002	0000		

Output Mapping Table		Data Type	Bytes
000	0661 Status Word	WORD	2
001	0395 Actual Speed Percent	REAL	4
002	0000		

A CoDeSys (V3.5 SP10) soft PLC running on a PC is used.

1. Start a new project from CoDeSys using a **CODESYS Control Win V3** device.
2. From the CoDeSys menu select **Tools->Device Repository...** and install the AC30 EDS file. The device will appear under Fieldbuses as shown.

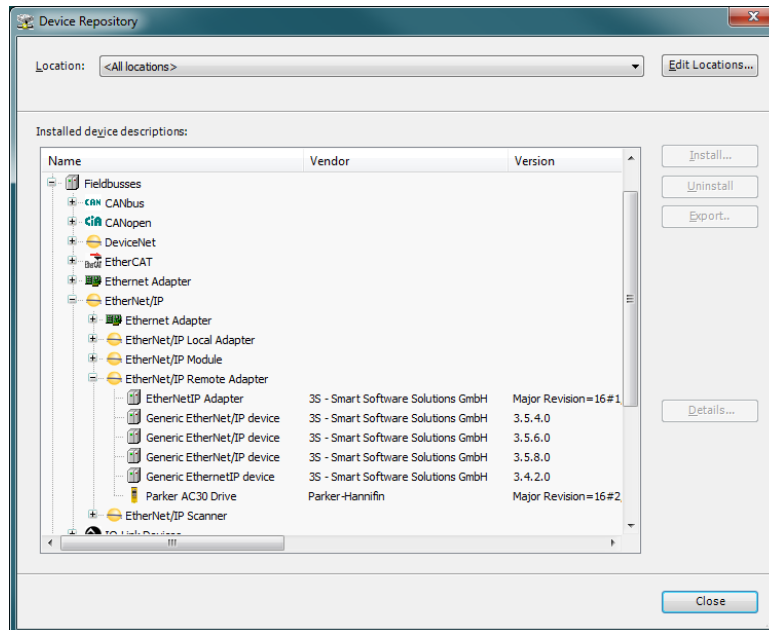

A-20 Fieldbuses

- Under Devices, select the **CODESYS Control Win 3** device, right click and select **Add Device...**, then add an **Ethernet Adapter**. Under the Ethernet device add an **EtherNet/IP Scanner**. Under the EtherNet/IP Scanner add a **Parker AC30 Drive**.

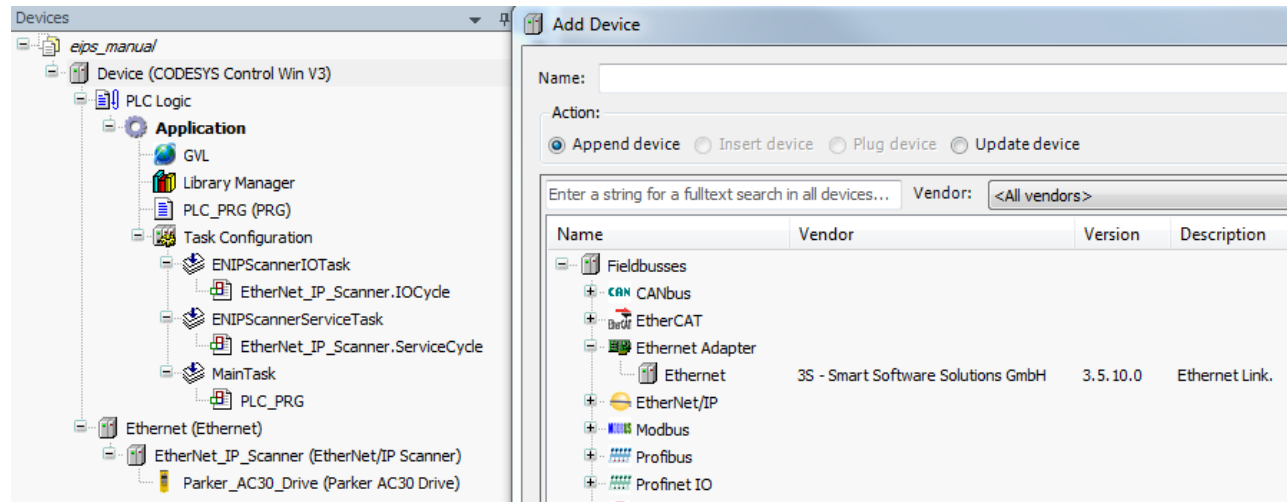

- Double-click on **CODESYS Control Win 3** and under **Communications Settings** tab select **Scan Network...** and select the required PC (note the softPLC on the PC must be started).

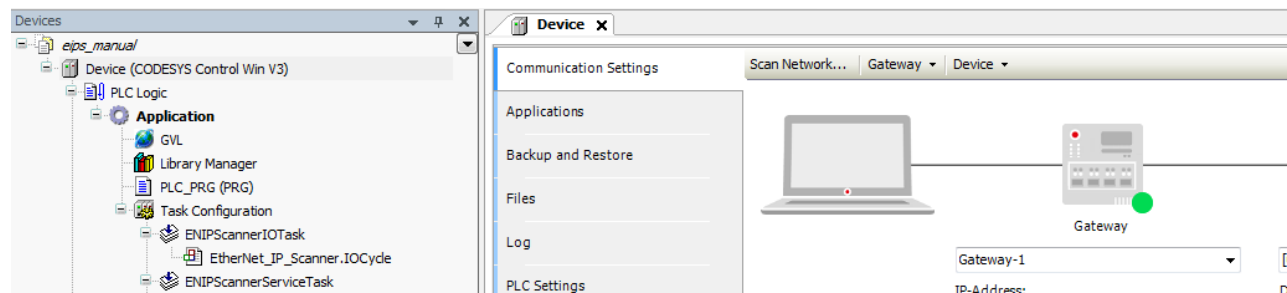

5. Double-click on **Ethernet** and under the **General** tab select the required interface.

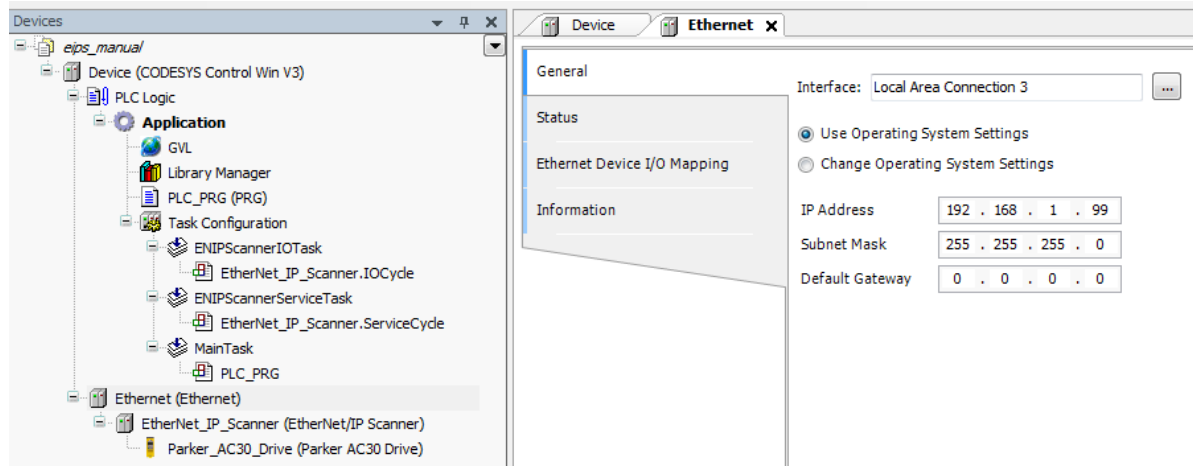

6. Double-click on **Parker AC30 Drive** and under the **General** tab set the IP address to that of the inverter.

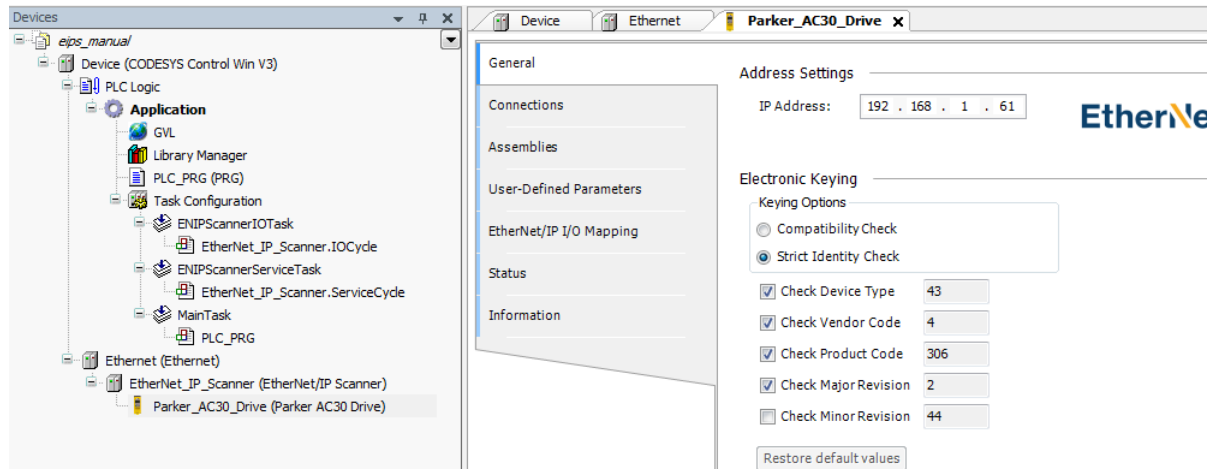

A-22 Fieldbuses

7. Under the **Connections** tab edit the connection if necessary. The input mapping uses a total of 6 bytes (O->T) and the output mapping also uses a total of 6 bytes (T->O). The mapping sizes on the inverter MUST match that on the PLC. The RPI (Requested Packet Interval) may also be changed.

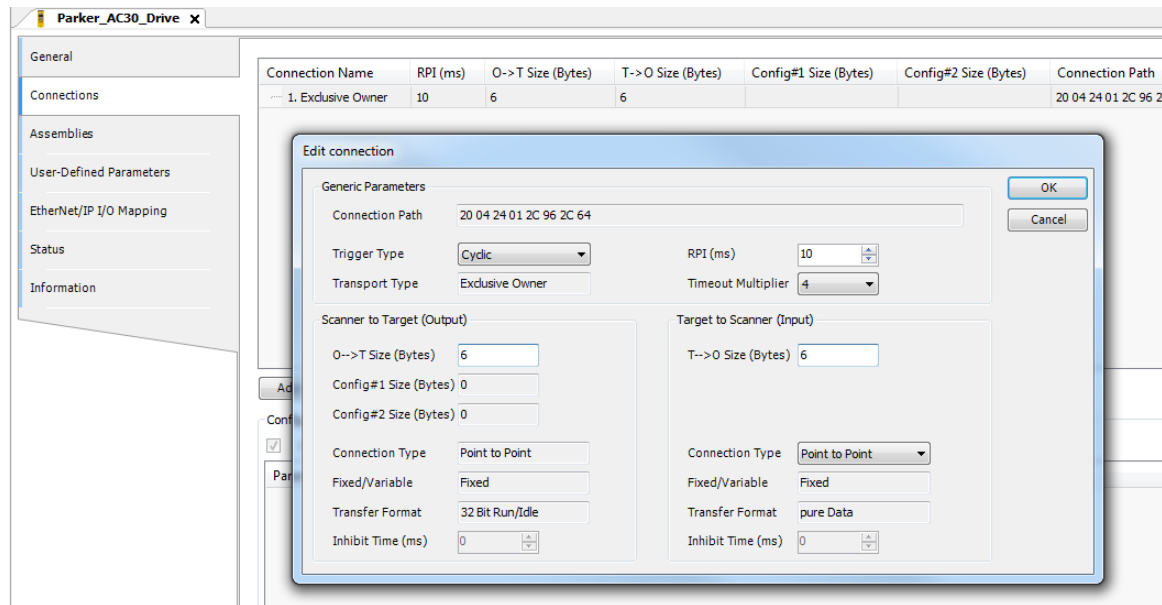

8. Under the EtherNet/IP IO Mapping tab the mappings can be seen.

%IB0 will be the first byte of the **Status Word** and **%IB2** will be the first byte of the **Actual Speed Percent**

%QB0 will be the first byte of the **Comms Control Word** and **%QB2** will be the first byte of the **Comms Reference**

Variable	Mapping	Channel	Address	Type	Unit	Descrip
		Input Param0	%IB0	BYTE		
		Input Param1	%IB1	BYTE		
		Input Param2	%IB2	BYTE		
		Input Param3	%IB3	BYTE		
		Input Param4	%IB4	BYTE		
		Input Param5	%IB5	BYTE		
		Output Param0	%QB0	BYTE		
		Output Param1	%QB1	BYTE		
		Output Param2	%QB2	BYTE		
		Output Param3	%QB3	BYTE		
		Output Param4	%QB4	BYTE		
		Output Param5	%QB5	BYTE		

9. In the application program the IO mappings can be accessed as variables as shown in this example.

```

1  PROGRAM PLC_PRG
2  VAR
3      status_word AT %IB0: WORD;
4      actual_speed_percent AT %IB2: REAL;
5      comms_control_word AT %QB0: WORD;
6      comms_reference AT %QB2: REAL;
7  END_VAR

```

A-24 Fieldbuses

Explicit Access of Parameters

Explicit access of the AC30 parameters is possible via the vendor specific object. Details of this are given in the section CIP Objects – Vendor Specific Object.

A parameter value may be read or written via Class **64h**, Attribute **5h**. The instance number is the same as the parameter number (PNO). The supported services are **Get Attribute Single** and **Set Attribute Single**.

String parameters use the SHORT_STRING format – the string is preceded by a single byte that specifies the length of the string.

Parameter Arrays

Parameter arrays may be accessed either as a whole or as a single element.

Using the parameter number (instance number) that represents the whole array with attribute 5h will return or modify the contents of all parameters.

Using the parameter number that represents a single element will return or modify only that element.

String arrays may not be accessed as a whole array, but may be accessed via each element.

Using a CoDeSys Based PLC

CoDeSys based PLCs can access parameters explicitly using the function blocks **Get_Attribute_Single** and **Set_Attribute_Single** from the library **EtherNetIP Services**.

Lost Communications Trip

A trip may be issued by the inverter on the loss of all Class1 connections of the EtherNet/IP adapter. To enable this, set the parameter **3129 EtherNet IP Trip** to **LOSS OF CONNECTION** and set the **ETHERNET IP BREAK** bit in the parameter **0730 ENABLE 33 – 64**.

Troubleshooting and Tips

The inverter fails to come out of configuration mode

The input or output mapping tables have invalid parameter mappings. The parameter **3130 EtherNet IP State** will report **ERROR**. Check the parameter **3131 EtherNet IP Diag** to determine which mapping table has the incorrect mapping. Note the input mapping table may only contain read-writable parameters.

Failure to make a connection

A connection between scanner and the adapter will not be made if:

- the input and output assembly data sizes of the scanner do not match the input and output mapping data sizes of the inverter
- the Requested Packet Interval (RPI) of the scanner is set to less than 2ms

Requested Packet Interval (RPI)

When mapping a large amount of data use an RPI of at least 10ms.

A-26 Fieldbuses

CIP Objects

The following CIP objects are supported:

01h	Identity
02h	Message Router
04h	Assembly
06h	Connection Manager
64h	Vendor Specific
F5h	TCP/IP Interface
F6h	Ethernet Link

Class Attributes

Each object has the following class attributes.

Attribute	Description	Type	Access
1	Revision	UINT	Get
2	Maximum Instance	UINT	Get
3	Number of Instances	UINT	Get
4	Optional Attribute List	UINT	Get
5	Optional Service List	UINT	Get
6	Maximum Class Attribute	UINT	Get
7	Maximum Instance Attribute	UINT	Get
Supported Service Code		Service Name	
0Eh		Get_Attribute_Single	

Identity Object – 01h

Instance	Attribute	Description	Type	Value	Access
1	1	Vendor	UINT	0004h (Parker Hannifin)	Get
	2	Device Type	UINT	002Bh (Generic)	Get
	3	Product Code	UINT	306	Get
	4	Product Revision	UINT	02C02h (minor/major)	Get
	5	Status	WORD	0	Get
	6	Serial Number	UDINT	Last 4 bytes of inverter MAC address	Get
	7	Product Name	SHORT STRING	“Parker AC30 Drive”	Get
Supported Service Code		Service Name			
01h		Get_Attribute_All			
05h		Reset - Type 0 and Type 1 Reset are supported ¹			
0Eh		Get_Attribute_Single			

1. Both Type 0 and Type 1 Reset will restart DHCP if enabled.

Message Router Object – 02h

Instance	Attribute	Description	Type	Value	Access
1	1	Object List	-	-	Get
	2	Total connections	UINT	-	Get
	3	Active connections	UINT	-	Get
Supported Service Code			Service Name		
01h			Get_Attribute_All		
0Eh			Get_Attribute_Single		

Assembly Object – 04h

Instance	Attribute	Description	Type	Value	Access
100	3	Input	USINT[500]	Parameter mapped values	Get
150	3	Output	USINT[496]	Parameter mapped values	Get/Set
Supported Service Code			Service Name		
0Eh			Get_Attribute_Single		
10h			Set_Attribute_Single		

Connection manager – 06h

There are no attributes for the Connection Manager.

A-28 Fieldbuses

TCP/IP Interface Object – F5h

Instance	Attribute	Description	Type	Value	Access
1	1	Status	UINT	0 Interface Configuration not configured 1 Interface Configuration comes from DHCP 2 Interface Configuration comes from non-CIP settings	Get
	2	Configuration capability	DWORD	Bit 2 – DHCP capable (1) Bit 5 – non-CIP setting capable (1)	Get
	3	Configuration control	DWORD	- If DHCP is disabled then writing a value of 0 is allowed - If DHCP is enabled then writing a value is 2 is allowed	Get/Set
	4	Physical Link Object Structure of:			Get
		Path Size	UINT	2	
		Path	Array of WORD	20F6h 2401h	
	5	Interface Configuration Structure of:			Get
		IP Address	UDINT	Inverter IP address	
		Network Address	UDINT	Inverter network mask	
		Gateway Address	UDINT	Inverter gateway address	
		Name Server	UDINT	0	
		Name Server 2	UDINT	0	
		Domain Server Size	UINT	Returns the Domain Name if DHCP is enabled and the DHCP server has provided it.	
		Domain Name	STRING		
	6	Host Name Structure of:		If DHCP is enabled and bound, returns the Host Name if the DHCP server has provided it, otherwise returns the default Host Name derived from the AC30 MAC address.	Get
		Size	UINT		
		Host Name	STRING		
	13	Encap TMO	UINT	Inactivity TMO seconds. On Type 1 Reset this value will revert to a value of 120.	Get/Set
Supported Service Code			Service Name		
01h			Get_Attribute_All		
0Eh			Get_Attribute_Single		
10h			Set_Attribute_Single		

Ethernet Link Object – F6h

Instance	Attribute	Description	Type	Value	Access
1	1	Interface Speed	UDINT	10 or 100	Get
2	2	Interface Flags	DWORD	Link status	Get
	3	Physical address	USINT[6]	MAC address	Get
	10	Interface label	SHORT STRING	“Port 1” or “Port 2”	Get
	11	Interface capability			Get
		Structure of:			
		Capability bits	DWORD	Auto-negotiation and MDIX supported (6)	
		Speed/duplex array count	USINT	0	
Supported Service Code			Service Name		
01h			Get_Attribute_All		
0Eh			Get_Attribute_Single		

Vendor Specific Object – 64h

The vendor specific object allows explicit access to AC30 parameters, including string parameters but excluding string arrays.

Instance	Attribute	Description	Type	Access
PNO	1	Parameter Name	SHORT STRING	Get
	2	CIP data type ¹	USINT	Get
	3	Number of parameter elements ²	USINT	Get
	4	Parameter qualifier	BYTE	Get
		Bit 0: Gettable		
		Bit 1: Settable		
	5	Parameter value	<i>Depends on parameter</i>	Get/Set
6	Parameter min value	<i>Depends on parameter</i>	Get	
7	Parameter max value	<i>Depends on parameter</i>	Get	
Supported Service Code			Service Name	
01h			Get_Attribute_All	
0Eh			Get_Attribute_Single	

1. Equivalent CIP data types – Volume 1 CIP Specification, Chapter 5A 14.2.1.2

2. For a standard parameter the number of elements will be 1, for a parameter array it will be the number elements in the array, and for a string parameter it will be the maximum number of characters.

A-30 Fieldbuses

Parameter Summary

The following parameters are relevant to the EtherNet/IP adapter.

Parameter Name	No.	Path	Default	Range	Writable
EtherNet IP Enable	3128	Setup::Communications::Base EtherNet IP Parameters::Base Comms::EtherNet IP Adapter	FALSE	FALSE TRUE	CONFIG
EtherNet/IP adapter parameter. / Enables the built-in EtherNet/IP adapter.					
EtherNet IP Trip	3129	Setup::Communications::Base EtherNet IP Parameters::Base Comms::EtherNet IP Adapter	LOSS OF CONNECTION	0: DISABLED 1: LOSS OF CONNECTION	CONFIG
EtherNet/IP adapter parameter. / Enables the EtherNet/IP trip on loss of connection.					
Enumerated values:					
0: DISABLED		the trip is disabled			
1: LOSS OF CONNECTION		the inverter will trip on the loss of all Class 1 connections			
EtherNet IP State	3130	Monitor::Communications::Base EtherNet IP Parameters::Base Comms::EtherNet IP Adapter	SETUP	0: SETUP 1: NW_INIT 2: WAITING TO CONNECT 3: CONNECTION IDLE 4: CONNECTION ACTIVE 5: ERROR 6, 7: <i>Reserved</i> 8: NONE	NEVER
EtherNet/IP adapter parameter.					
Diagnostic indicating the state of the EtherNet/IP adapter.					
Enumerated values:					
0: SETUP		EtherNet/IP adapter enabled – the inverter is in the configuration state			
1: NW_INIT		network initialization			
2: WAITING TO CONNECT		waiting for a Class 1 connection			
3: CONNECTION IDLE		Class 1 connection made with scanner in Idle mode			
4: CONNECTION ACTIVE		Class 1 connection made with scanner in Run mode			
5: ERROR		configuration error			
8: NONE		EtherNet/IP adapter disabled			

A-32 Fieldbuses

PROFINET IO Device

Introduction

The built-in PROFINET IO device (slave) is implemented in the AC30P/D inverters.

To make use of this feature, firmware version V4.x.x needs to be installed in the inverter. The firmware may be updated by downloading the firmware file from the Parker website (see section *Firmware Update* in Chapter 4) or installed from the latest version of PDQ. With version V4.x.x firmware installed, the **AC30PNIO** CoDeSys (PDQ/PDD) device is required.

Note: V4.x.x firmware has no AFE support and an application size of 96Kbytes (rather than 192Kbytes). The switching frequency is limited to 10kHz for induction motor control and 8kHz for PMAC motor control.

Features

The following PROFINET IO features are implemented:

- Minimum cyclic update time of 8ms
- Up to 64 slots
- Input mapping of up to 32 inverter parameters
- Output mapping of up to 32 inverter parameters
- Access of inverter parameters via read and write records
- Local or DCP address assignment

Identity

The PROFINET IO device has the following identity:

Vendor ID: **0x010F**

Vendor Name: **Parker Hannifin**

Product Code **0xAC30**

Inverter Configuration

Enabling

To enable the PROFINET IO device set the parameter **3132 PROFINET Enable** to **TRUE**. Note the PROFINET IO device will only operate when the inverter is the Operational state.

The current state of the PROFINET IO device is given by the parameter **3143 PROFINET State**.

Station Name

A station name must be assigned to the PROFINET device. This is set using a PROFINET configuration program. Typically this is done from within the PC program used to program the PROFINET PLC. The station name is stored in non-volatile memory within the inverter.

The station name should consist of only alpha-numeric, period (.) and hyphen (-) characters. The diagnostic parameter **3136 PROFINET Station Name** shows the first 21 characters of the station name.

Update Time

The cyclic I/O update time is set by the PLC. Update times allowed are calculated by multiples (8, 16, ..., 512) of the send clock (1ms). Thus the lowest update time is **8ms**. However due to constraints in the inverter the update time is further restricted by the switching frequency, as given in the table below.

Note: If an update time that exceeds the restrictions is attempted then **a connection by the PLC will be rejected by the inverter** and the parameter **3144 PROFINET Diagnostic** will be in the **CONNECTION REJECTED** state.

Minimum I/O Update Time				
Switching Frequency	2-4kHz	4-6kHz	6-8kHz	8-10kHz
Induction motor control	8ms	8ms	16ms	32ms
PMAC motor control	8ms	16ms	32ms	Not permitted

It is recommended to increase the update time for larger mapped cyclic I/O data.

A-34 Fieldbuses

IP Address Assignment

Local and **DCP** IP address assignment is supported.

Local assignment refers to setting the IP address via the GKP, using the tools PDQ or PDD, or from within the inverter's application. For the AC30, local assignment also can refer to the use of DHCP or Auto-IP.

DCP assignment refers to setting the IP address via a PROFINET configuration tool or from the PLC itself when a connection is made. This is either marked as permanent or temporary.

The current IP settings of the inverter are monitored using the parameters:

0926 IP Address

0927 Subnet Mask

0928 Gateway Address

Local Assignment

If parameter **0929 DHCP** is set to TRUE, then the IP address will be set from the DHCP server on the network, if one is available.

If parameter **0930 Auto IP** is set to TRUE, then the IP address will be automatically be assigned a link-local address.

If both parameters **0929 DHCP** and **0930 Auto IP** are FALSE, then the IP address, subnet mask and gateway address will be set from the values in the parameters:

0933 User IP Address

0934 User Subnet Mask

0935 User Gateway Address

DCP Assignment

When the IP address is set via DCP then the parameters **0929 DHCP** and **930 Auto IP** will both automatically be set to FALSE.

Note: The enabling of DHCP via DCP is not possible.

The IP address is stored in non-volatile memory and marked as temporary or permanent when the IP address is assigned via DCP. If the IP address is marked as temporary, when the PROFINET device is re-enabled or power-cycled the IP address will be 0.0.0.0 as per the PROFINET specification. If it is preferred that this does not happen then the parameter **3134 PROFINET Use Drive IP** should be set to TRUE. In this case, on enabling the PROFINET device the last IP address of the inverter will be used.

I/O Parameter Mapping

The input and output mappings of the inverter parameters are set in the parameters **3000 Input Mapping** (PLC->inverter) and **3064 Output Mapping** (inverter->PLC). Parameters created in the application may be added into the mapping. The mapping of each table ends on the first zero entry.

The PROFINET device and GSD file defines a number of input and output modules that plug into the slots. The modules used depend on the type of parameter that is being mapped. This is summarized in the table.

AC30 Data Type	PROFINET module
REAL	Real
SINT	Integer8
INT	Integer16
DINT	Integer32
BOOL	Unsigned8
USINT (incl enumerated)	
BYTE	
UINT	Unsigned16
WORD	
UDINT	Unsigned32
DWORD	
TIME	
DATE	
TIME_OF_DAY	
DATE_AND_TIME	

For the inverter input mapping (output from the PLC) each parameter must be read-writable. Parameter arrays, configuration type parameters, string parameters, password parameters and reserved parameters are not permitted. The AC30 default input mapping is given in the table alongside the equivalent mapping required in the PLC.

AC30 Input Mapping Table			PLC Outputs
	AC30 Parameter	Data Type	Plugged Modules
000	0627 Comms Control Word	WORD	Output Unsigned16
001	0681 Comms Reference	REAL	Output Real
002	0000		

For the inverter output mapping (input to the PLC) each parameter may be read-only or read-writable. Parameter arrays, string parameters and password parameters are not permitted. The AC30 default output mapping is given in the table alongside the equivalent mapping required in the PLC.

AC30 Output Mapping Table			PLC Inputs
	AC30 Parameter	Data Type	Plugged Modules
000	0661 Status Word	WORD	Input Unsigned16
001	0395 Actual Speed Percent	REAL	Input Real
002	0000		

If the input and output mappings have invalid entries then the parameter **3143 PROFINET State** will report **ERROR** and the inverter will not go into the Operational state. The parameter **3144 PROFINET Diagnostic** can be used to determine which mapping table has an invalid entry.

Note: On the PLC all output modules must be plugged before input modules.

A-36 Fieldbuses

GSD File

The latest PROFINET GSD file for the inverter may be downloaded from www.parker.com

The GSD file may also be downloaded directly from the drive via a web browser. To access this make sure the parameter **0944 Web Access** is set to LIMITED or FULL.

Enter the inverter IP address into the web browser and access the web page “**Services**” and under **PROFINET GSDML file** click the Download button. Alternatively type the following into the browser address bar (replacing **ip_address** with the inverter’s IP address):
ip_address/eds/pnio.zip

The GSD file has the default mapping modules are ready plugged. This may be modified within the PLC configuration tool as required.

Example PLC Configurations

The examples in this section uses the default parameter mapping of the inverter:

AC30 Input Mapping Table			PLC Outputs
	AC30 Parameter	Data Type	Plugged Modules
000	0627 Comms Control Word	WORD	Output Unsigned16
001	0681 Comms Reference	REAL	Output Real
002	0000		

AC30 Output Mapping Table			PLC Inputs
	AC30 Parameter	Data Type	Plugged Modules
000	0661 Status Word	WORD	Input Unsigned16
001	0395 Actual Speed Percent	REAL	Input Real
002	0000		

Example Using a SIMATIC S7-300 PLC and SIMATIC Manager

1. Create a project

Start **SIMATIC Manager** and create a new project. Right-click on the project name at the top level and from **Insert New Object** select **SIMATIC 300 Station**.

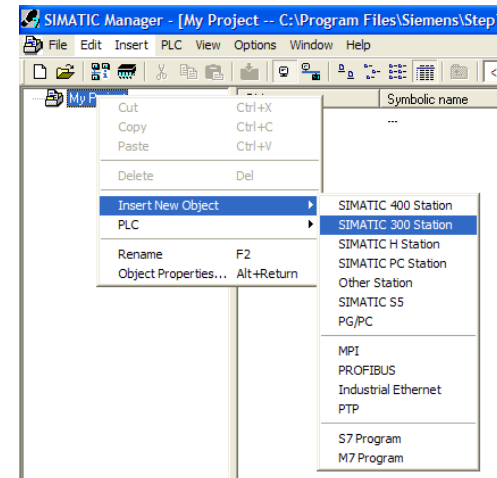

A-38 Fieldbuses

2. PLC Interface

The interface between the PLC and PC is selected by clicking on the **Options** menu and choosing **Set PG/PC Interface**.

In this example the PC Ethernet card is chosen.

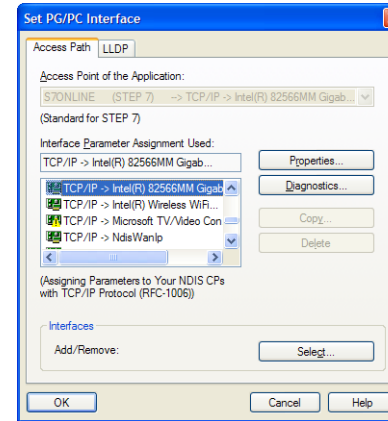

3. Start HW Config.

To configure the PLC, click on **SIMATIC 300** and double-click on **Hardware**. This will start **HW Config**.

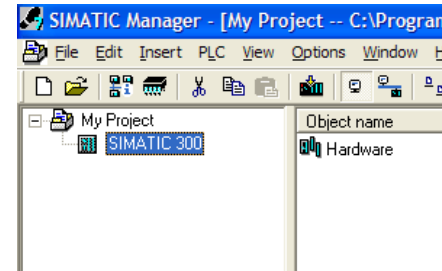

4. Configure the PLC hardware.

In HW Config, select **Insert** from the menu followed by **Insert Object**. From the pop-up menu choose SIMATIC 300 → RACK 300 → Rail. The rail should then appear as shown.

Right-click on slot 1 to add the appropriate power supply.

Right-click on slot 2 to add the appropriate CPU.

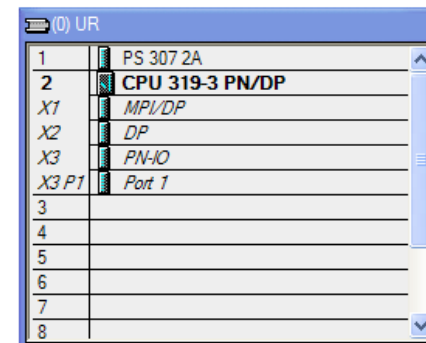

5. Install the GSD file.

Install the PROFINET IO GSD XML file. This can be downloaded from <http://www.parker.com> or from the inverter's web server.

From the **Options** menu select **Install GSD File...**

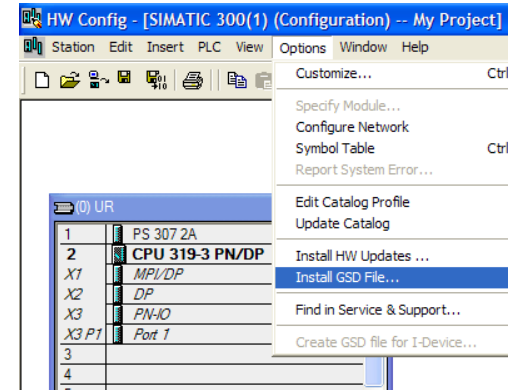

This will then become available in the catalogue shown on the right-hand side of the window under PROFIBUS IO →Additional Field Devices →Drives →AC30

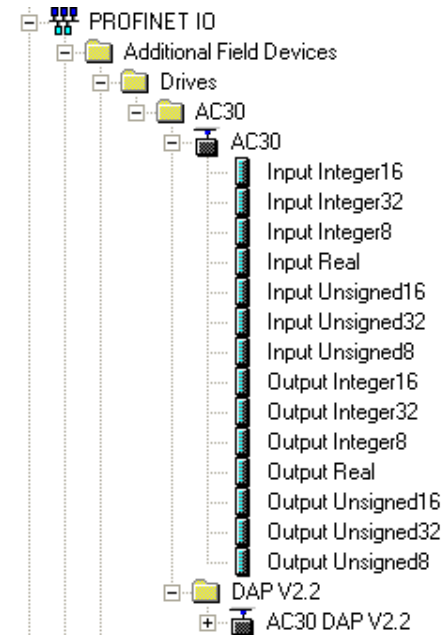

A-40 Fieldbuses

6. Add the PROFINET Controller.

Double-click on the PROFINET IO (**PN-IO**) Controller module to reveal the dialog box. Click on **Properties...** to set up the IP address and Subnet mask.

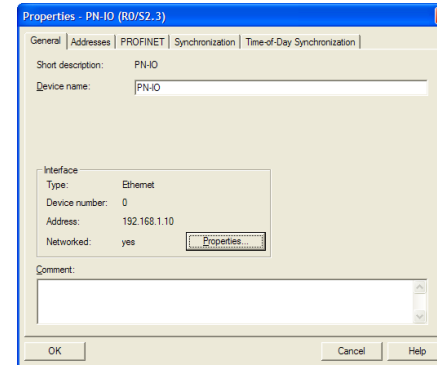

Click on **New...** to create a new network and select this.

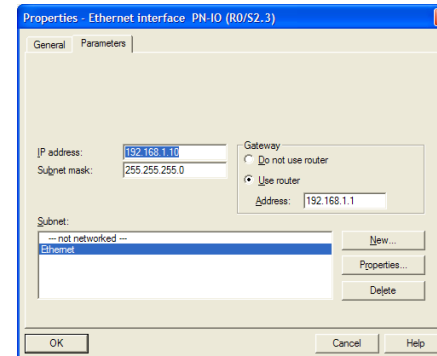

Right-click on the PROFINET IO (**PN-IO**) Controller module and select **Insert PROFINET IO System**.

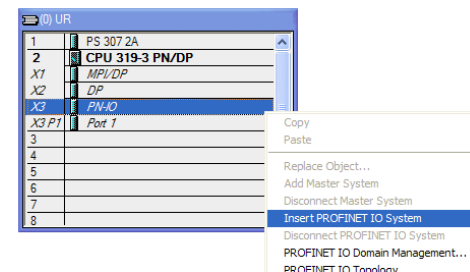

7. Add the slave.

Click and drag the AC30 device from the catalogue and drop onto the **PROFINET IO System**.

Two Device Access Points (DAPs) are available: **AC30** and **AC30 DAP V2.2**

- Normally the **AC30** DAP would be used.
- For older controllers that do not support extended PROFINET diagnostics, **AC30 DAP V2.2** should be used.

Double click on the PROFINET slave device to configure it.

Set the Device Name (Station Name) of the slave.

If the IP address of the slave is to be set by the PLC via DCP, check the **Assign IP address via IO controller** and click on **Ethernet...** to configure.

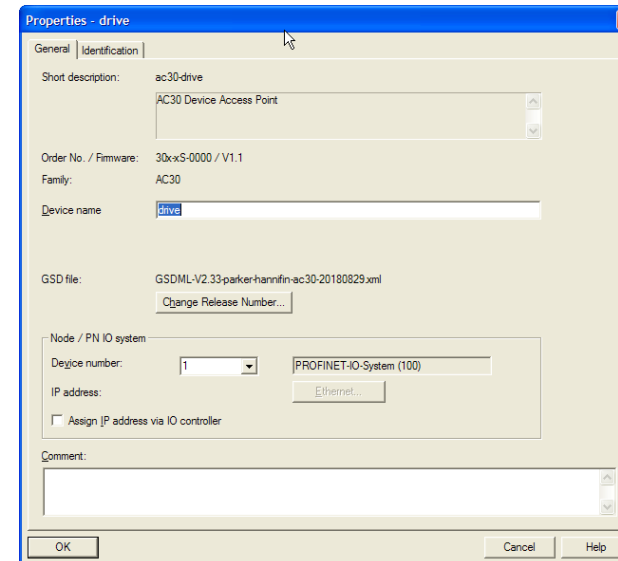
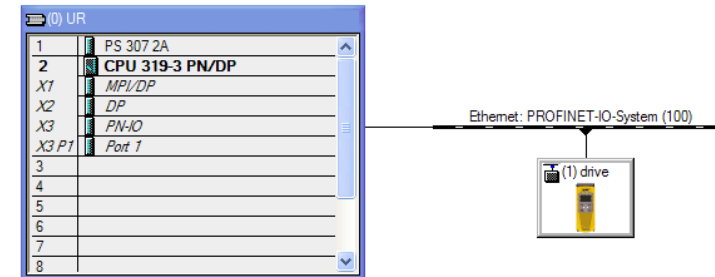

A-42 Fieldbuses

8. Assign the Device Name of the PROFINET Slave

Double-click on the PROFINET IO-System to reveal the dialog box. Make sure the checkbox **Use Name in IO-Device / Controller** is cleared, otherwise the device name will require a dot extension.

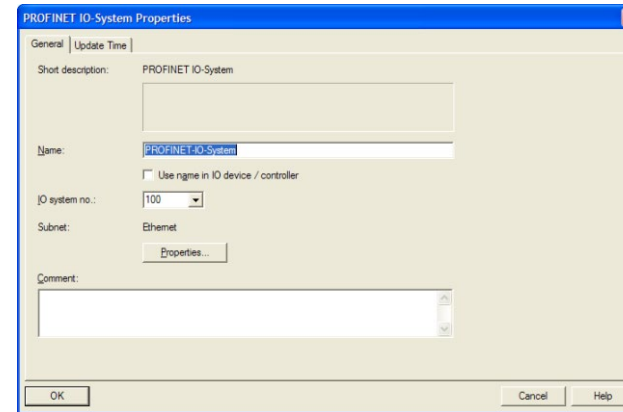

If the Station Name (Device Name) of the slave is not yet set or is to be changed then select **PLC** from the menu and choose **Assign Device Name...** to reveal the dialog box.

To carry out this task, an Ethernet interface must be used between the PC and PLC (see part 2 above).

Make sure the slave device is connected to the network.

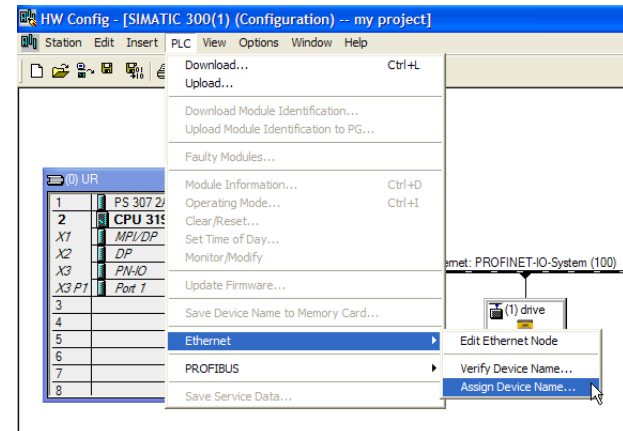

The **Device name** drop down contains a list of all the device names of the slaves in the PLC configuration.

The **Available devices** list show all connected slaves.

Match the device name with the available device and click on **Assign name**. The slave will then take on its device name. This can be seen on the inverter parameter **3143 PROFINET Station Name**.

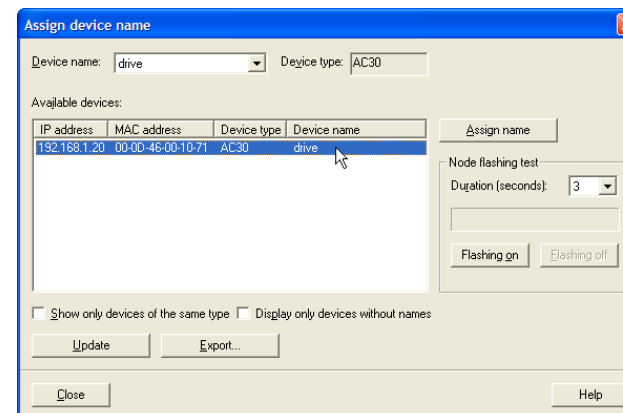

To help identify the slave click on **Flashing on**. The AC30 GPK will flash.

9. Configure the process data for the slave.

By clicking on the slave, the input and output process data may be configured. This must match the configuration set up in the AC30.

The appropriate input and output modules may be dragged from the catalogue and dropped into the appropriate slot. All output modules must come before the input modules.

The default modules will be seen already plugged. These may be changed as necessary.

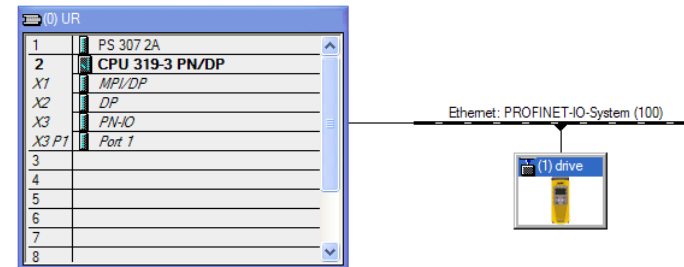

Slot	Module	Order Number	I Address	Q address	Diagnostic address	Comment
0	drive	30x-x5-0000			8186*	
X1	Interface				8185*	
F1	Port 1 RJ45 10/100 MBit				8184*	
F2	Port 2 RJ45 10/100 MBit				8183*	
1	Output Unsigned16			0..1		
2	Output Real			256..259		
3	Input Unsigned16		0..1			
4	Input Real		256..259			

10. Set the required update time.

Double click on the **PROFINET IO System** and click on the **Update Time** tab. The update time of the AC30 may be changed.

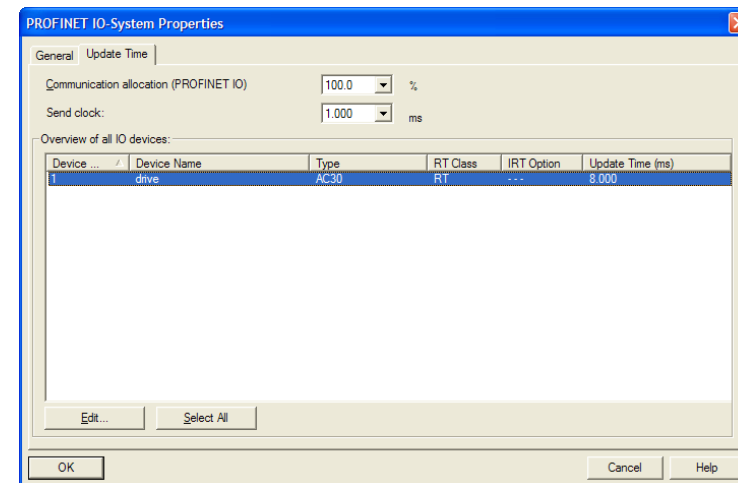

11. Save, compile and download.

Make sure the PC/PLC interface is connected. Select **Station** from the menu and **Save and Compile** then select **PLC** and **Download...**

A-44 Fieldbuses

Example Using a CoDeSys Based PLC

A CoDeSys (V3.5 SP11) soft PLC running on a PC is used.

1. Start a new project from CoDeSys using a **CODESYS Control Win V3** device.
2. From the CoDeSys menu select **Tools->Device Repository...** and install the AC30 GSD file. The device will appear under Fieldbuses as shown. Two device access points (DAPs) are given: **AC30** and **AC30 DAP V2.2**. Normally **AC30** DAP would be used.

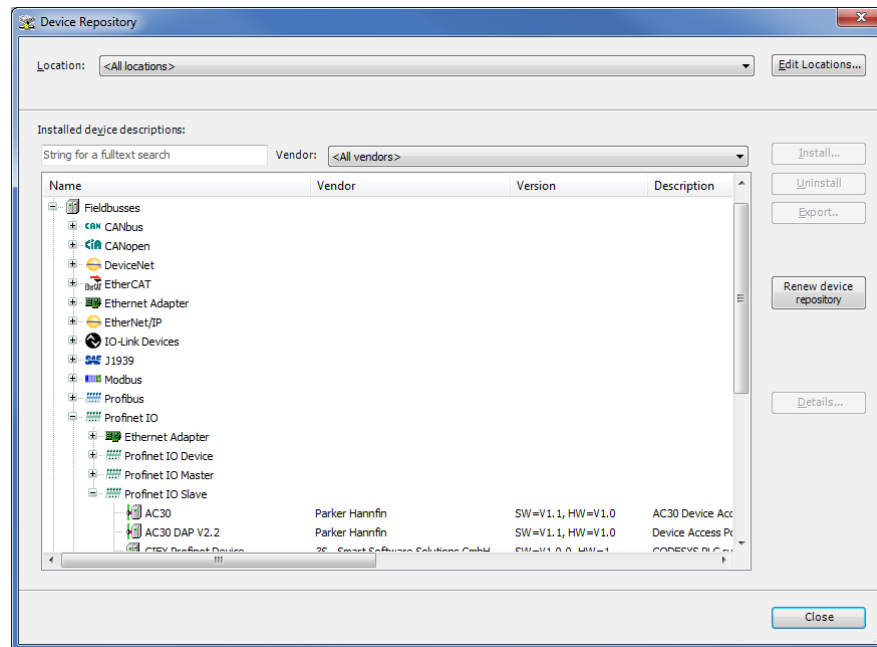

- Under Devices, select the **CODESYS Control Win 3** device, right click and select **Add Device...**, then add an **Ethernet Adapter**. Under the Ethernet device add a **PN-Controller**.

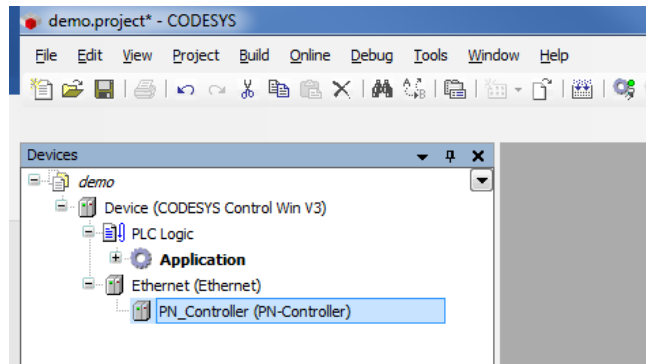

- Under the **PN-Controller** right-click add the **AC30** device. The default output and input modules will be added. These may be changed as required. Double-click on the AC30 device to modify the station name, IP address and update rate as required.

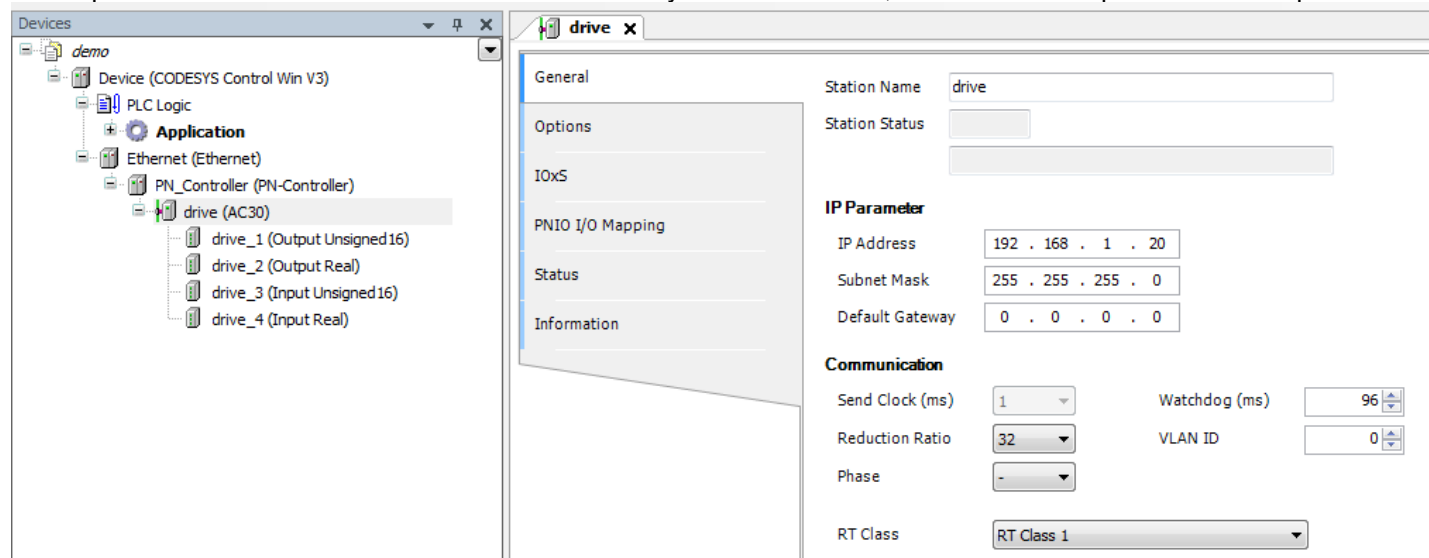

A-46 Fieldbuses

5. Double-click on **CODESYS Control Win 3** and under **Communications Settings** tab select **Scan Network...** and select the required PC (note the soft PLC on the PC must be started).

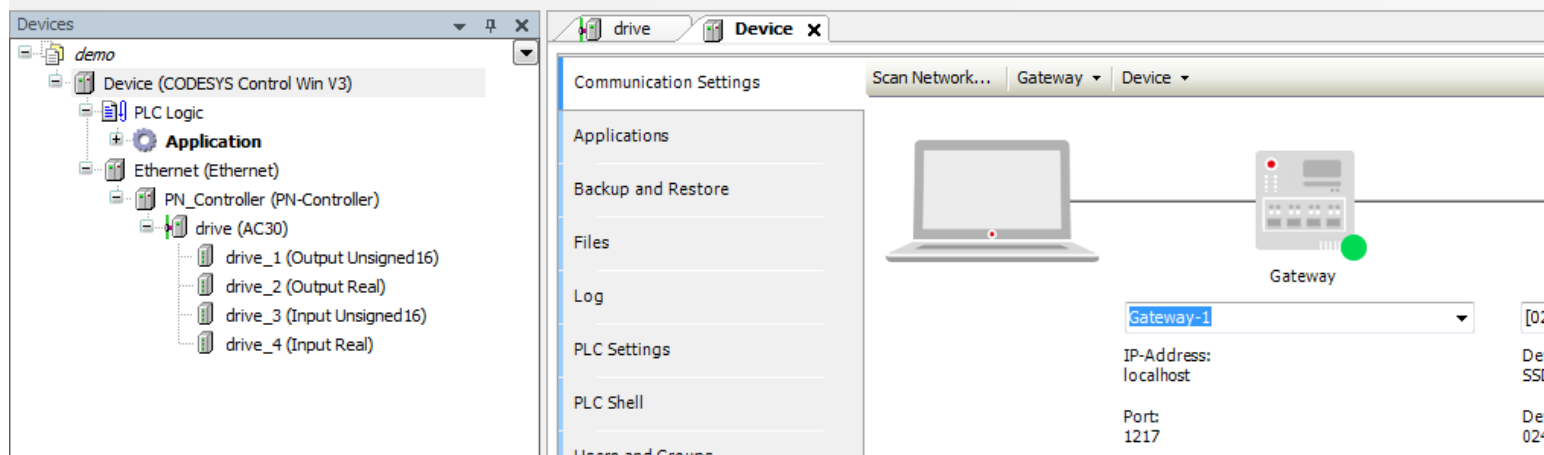

6. The Output and Input modules may be mapped to application variables in the PLC program. Double click on the required module and select the **PNIO Module I/O Mapping** tab. Under **Variable** click on the ellipses to select the required application variable.

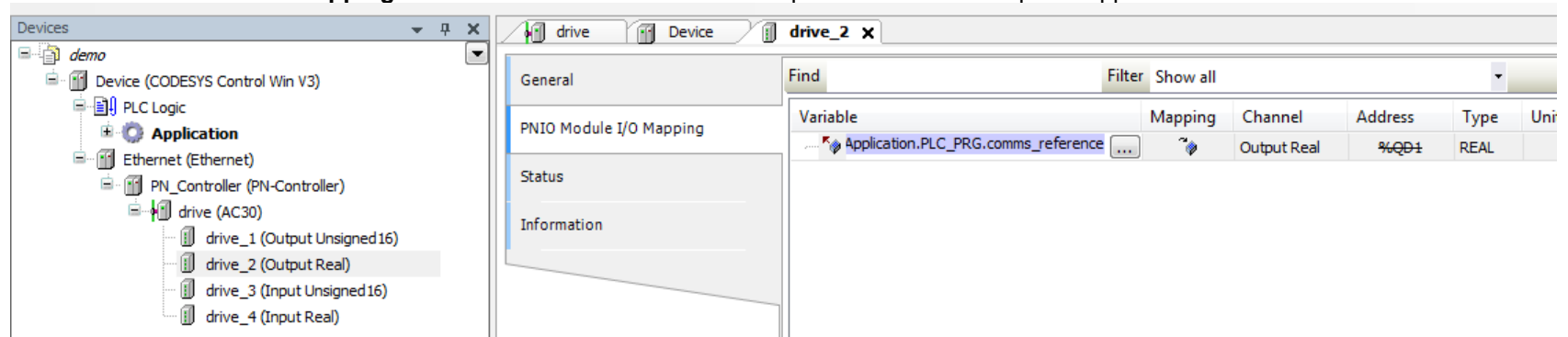

7. Set the Station Name of the inverter if it is not already set:

Make sure the inverter is connected to the network and PROFINET is enabled. Go online with the PLC and right-click on the **PN-Controller** and select **Scan for Devices...** The **Station Name** of the required device can be modified. Select **Set Name+IP** for this to take effect.

Note that the device may also be added from this dialog box rather than adding it manually.

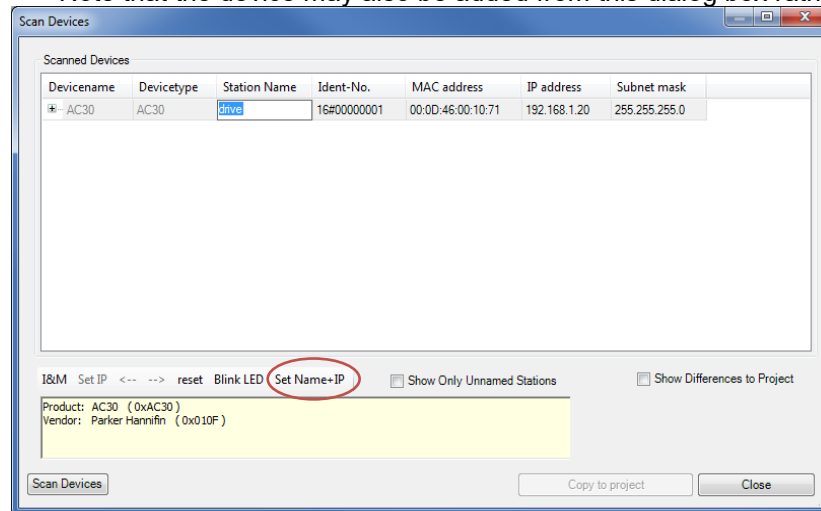

8. Build the project and go online.

A-48 Fieldbuses

Acyclic Access of Inverter Parameters

Acyclic access of inverter parameters by the PLC is possible using read and write record requests in the user specific index range (0 to 0x7FFF).

Access is achieved via any plugged slot/subslot, however use of the DAP slot is recommended as this is always plugged regardless of the application. There is a direct relationship between the Parameter Number (PNO) and the record Index. This is shown in the table below.

API	Slot	Subslot	Index
0	0 (DAP)	1 (DAP)	Parameter number (PNO)
		0x8000 (Interface)	
		0x8001 (Port 1)	
		0x8002 (Port 2)	
	Other plugged slot/subslot		

The current value of the parameter plugged into a slot/subslot may also be read using index 0. Writing to a parameter via index 0 is not possible.

Function Blocks

The functions blocks RDREC and WRREC are used for read requests and write requests respectively. The inputs / outputs to the function blocks of interest are:

Inputs	Description	Notes
REQ	Starts a request	-
ID	Identifier of a slot/subslot	For a Step 7 PLC the diagnostic address found in Slot 0 and Subslot 1 would be used. For a CoDeSys PLC the ID field of the PROFINET slave would be used.
INDEX	Index of the record data	To access the inverter parameters use the PNO for the index
MLEN	Data length	RDREC only - maximum length of the data to be read. See Read Record section
LEN	Data length	WRREC only - length of the data to be written. See Write Record section.
RECORD	Record data	Data will be written to this area following a read request. Data will be read from this area for a write request.

Outputs	Description	Notes
LEN	Length of read data	RDREC only
VALID	New data received and is valid	RDREC only
DONE	Data written	WRREC only
BUSY	Function block is busy	-
ERROR	Error detected	See Record Error Codes section
STATUS	Last detected status	See Record Error Codes section

Read Record

The RDREC function block is used to read a record. The record data and **MLEN** input must be **at least** the size of the parameter being read:

- For a standard parameter either 1,2 or 4 bytes respectively
- For an array parameter the total number of bytes of all elements
- For a string parameter the maximum number of characters allowed for the string plus 1 for the null terminator

Write Record

The WRREC function block is used to write to a record. The **LEN** input must be **equal to** the size as the parameter being written to unless it is a string parameter:

- For a standard parameter either 1,2 or 4 bytes respectively
- For an array parameter the total number of bytes of all elements
- For a string parameter LEN should be no more than the maximum number of characters allowed for the string plus 1 for the null terminator

Endian

The endian type for acyclic read and write requests of AC30 parameters is set using parameter **3135 PROFINET Acyclic Endn**. This does not apply to the cyclic I/O data which is always Big Endian.

Record Error Codes

If the inverter cannot process a parameter read or write request then the **ERROR** output of the function block will be set TRUE and the **STATUS** output will be set to one of the following error codes:

Code	0xDE	Read Response
	0xDF	Write Response
Decode	0x80	PNIO Read/Write
Code 1	0x80	Invalid Index
	0x81	Write Length Error
	0x82	Invalid Slot or Subslot
	0x84	Invalid Area API
	0x86	Access Denied
	0x87	Invalid Range
	0x8B	User Specific (record length not big enough)
Code 2	0	-

A-50 Fieldbuses

Example Acyclic Access of Parameters

A CoDeSys (V3.5 SP11) soft PLC running on a PC is used. In this example, two parameters are accessed:

- Reading from parameter 0005 Digin Value of data type WORD
- Writing to parameter 0305 Current Limit of data type REAL

Example structured text code to access these parameters acyclically is shown below.

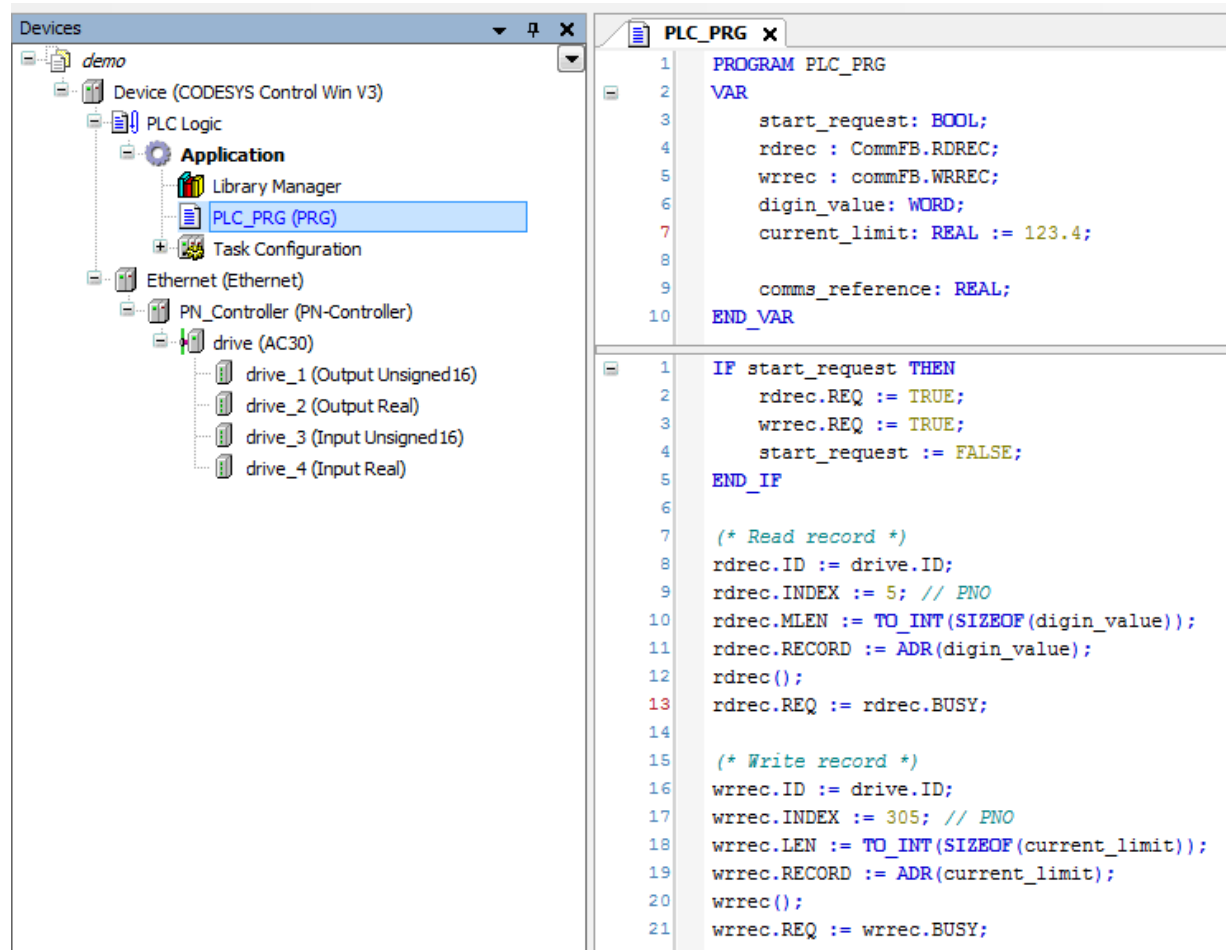

```
1 PROGRAM PLC_PRG
2 VAR
3     start_request: BOOL;
4     rdrec : CommFB.RDREC;
5     wrrec : commFB.WRREC;
6     digin_value: WORD;
7     current_limit: REAL := 123.4;
8
9     comms_reference: REAL;
10 END_VAR
11
12 IF start_request THEN
13     rdrec.REQ := TRUE;
14     wrrec.REQ := TRUE;
15     start_request := FALSE;
16 END_IF
17
18 (* Read record *)
19 rdrec.ID := drive.ID;
20 rdrec.INDEX := 5; // PNO
21 rdrec.MLEN := TO_INT(SIZEOF(digin_value));
22 rdrec.RECORD := ADR(digin_value);
23 rdrec();
24 rdrec.REQ := rdrec.BUSY;
25
26 (* Write record *)
27 wrrec.ID := drive.ID;
28 wrrec.INDEX := 305; // PNO
29 wrrec.LEN := TO_INT(SIZEOF(current_limit));
30 wrrec.RECORD := ADR(current_limit);
31 wrrec();
32 wrrec.REQ := wrrec.BUSY;
```

Lost Communications Trip

A trip may be issued by the inverter on the loss of connection to the PLC. To enable this, set the parameter **3133 PROFINET Trip** to **ENABLED** and set the **FIELD BUS BREAK** bit in the parameter **0730 ENABLE 33 – 64**.

With the motor running, the trip will occur when the parameter **3143 PROFINET State** transitions from the **CONNECTED** state to any other state.

Troubleshooting and Tips

Inverter fails to come out of configuration mode

- Check the parameter **3144 PROFINET Diagnostic** for **INPUT MAPPING FAILED** or **OUTPUT MAPPING FAILED**. See Parameter Mapping section.

Inverter fails to come out of Waiting for Connection PROFINET state

- Check that the Station Name has been set. See Station Name section.
- Make sure the Update Time is set to an appropriate rate for the control mode / switching frequency. Check the parameter **3144 PROFINET Diagnostic** for **CONNECTION REJECTED** state. See Update Time section.

PLC reports incorrect module

- Check the parameter **3144 PROFINET Diagnostic** for **MAPPING MISMATCH** state. Make sure the parameter mappings on the inverter match those of the PLC (see Parameter Mapping section).
 - The inverter Input Mapping table must match the plugged Output Modules of the PLC
 - The inverter Output Mapping table must match the plugged Input Modules of the PLC
 - All Output Modules must be plugged before the Input Modules on the PLC

The inverter loses its IP address at startup

- When the IP address is set with a temporary flag using DCP, the IP address will startup as 0.0.0.0 when the inverter is power-cycled or PROFINET is enabled. The IP address is subsequently set when the PLC next makes a connection. This behavior is part of the PROFINET standard. However, this may be overridden by setting the parameter **3134 PROFINET Use Drive IP** to TRUE so that the last IP address used will be set at startup. See DCP Assignment section.

A-52 Fieldbuses

Parameter Summary

Parameter Name	No.	Path	Default	Range	Writable
PROFINET Enable	3132	Setup::Communications::Base PROFINET Parameters::Base Comms::PROFINET IO Device	FALSE	FALSE TRUE	CONFIG
PROFINET IO parameter. Enables the built-in PROFINET IO Device.					
PROFINET Trip	3133	Setup::Communications::Base PROFINET Parameters::Base Comms:: PROFINET IO Device	ENABLED	0: DISABLED 1: ENABLED	CONFIG
PROFINET IO parameter. Enables the FIELDBUS BREAK trip on loss of connection. Enumerated values: 0: DISABLED the trip is disabled 1: ENABLED the inverter will trip on the loss of connection to the PLC					
PROFINET Use Drive IP	3134	Setup::Communications::Base PROFINET Parameters::Base Comms:: PROFINET IO Device	FALSE	FALSE TRUE	CONFIG
PROFINET IO parameter. Determines the IP address after PROFINET is enabled or the AC30 is power-cycled. If set to FALSE then the behaviour is that of the PROFINET standard and the IP address will be set to zero if the IP address were previously set by DCP with the temporary setting. If set to TRUE then the IP address will be the last IP address set.					
PROFINET Acyclic Endn	3135	Setup::Communications::Base PROFINET Parameters::Base Comms:: PROFINET IO Device	BIG ENDIAN	0: LITTLE ENDIAN 1: BIG ENDIAN	WRITABLE
PROFINET IO parameter. Sets the endian type for acyclic read and write requests of AC30 parameters. This does not apply to the cyclic I/O data which is always Big Endian. Enumerated values: 0: LITTLE ENDIAN The least significant byte (LSB) of the data is sent first. 1: BIG ENDIAN The most significant byte (MSB) of the data is sent first.					
PROFINET Station Name	3136	Monitor::Communications::Base PROFINET Parameters::Base Comms::PROFINET IO Device	-	-	NEVER
PROFINET IO parameter. Indicates the PROFINET device Station Name. Only the first 21 characters are displayed.					

Parameter Name	No.	Path	Default	Range	Writable
PROFINET State	3143	Monitor::Communications::Base PROFINET Parameters::Base Comms::PROFINET IO Device	NONE	0: SETUP	NEVER
				1: NW_INIT	
				2: WAITING TO CONNECT	
				3: STOP MODE	
				4: CONNECTED	
				5: ERROR	
				6, 7: <i>Reserved</i>	
				8: NONE	

PROFINET IO parameter.

Diagnostic indicating the state of the PROFINET IO Device.

Enumerated values:

0: SETUP	PROFINET IO enabled – the inverter is in the configuration state
1: NW_INIT	Network initialization
2: WAITING TO CONNECT	Waiting for a connection to a PLC
3: STOP MODE	Connection made in Stop Mode – inverter parameters will not be written to by the PLC
4: CONNECTED	Connection made in Run mode
5: ERROR	Configuration error
8: NONE	PROFINET IO disabled

PROFINET Diagnostic	3144	Monitor::Communications::Base PROFINET Parameters::Base Comms::PROFINET IO Device	NONE	0: NONE	NEVER
				1: INPUT MAPPING FAILED	
				2: OUTPUT MAPPING FAILED	
				3: CONNECTION REJECTED	
				4: MAPPING MISMATCH	

PROFINET IO parameter.

Diagnostic indicating if there is a configuration error.

Enumerated Values:

0: NONE	No configuration error
1: INPUT MAPPING FAILED	Invalid input mapping
2: OUTPUT MAPPING FAILED	Invalid output mapping
3: CONNECTION REJECTED	Inverter has rejected a connection attempt from the PLC due to invalid switching frequency and update time combination.
4: MAPPING MISMATCH	The mapping between the PLC and inverter does not match. A connection may still be allowed in this state.

A-54 Fieldbuses

Parameter Name	No.	Path	Default	Range	Writable
Input Mapping	3000	Setup::Communications::Base PROFINET	0627	0000	NEVER
		Parameters::Base Comms::Fieldbus Mapping	0681	Maximum	
			0000	parameter number	
			...		
PROFINET IO parameter. List of PNOs for the built-in fieldbus input parameter mapping. These map to the PLC output modules.					
Output Mapping	3064	Setup::Communications::Base PROFINET	0661	0000	NEVER
		Parameters::Base Comms::Fieldbus Mapping	0395	Maximum	
			0000	parameter number	
			...		
PROFINET IO parameter. List of PNOs for the built-in fieldbus output parameter mapping. These map to the PLC input modules.					

Appendix B: Sequencing Logic

Drive State Machine

DS402

The sequencing of the inverter is based on the DS402 / DriveCOM / IEC 61800-7 standard as used by most industrial fieldbuses . This allows it to be easily controlled and monitored by a PLC using the standards' Control Word and Status Word.

Sequencing State

The sequencing state of the unit is indicated by an enumerated value given by the **0678 Sequencing State** parameter.

Value	DS402 Sequencing State	Description
0	NOT READY TO SWITCH ON	Not ready to switch on. The drive is initialising or being configured.
1	SWITCH ON DISABLED	The Drive will not accept a switch on command
2	READY TO SWITCH ON	The Drive will accept a switch on command.
3	SWITCHED ON	The Drive will accept an Operation Enable (Run or Jog) command. - Power stage of the Drive is ready to operate. - Voltage has not yet been applied to the motor terminals.
4	OPERATIONAL ENABLED	Normal operational state of the drive. This state includes Running, Jogging, Stopping (Disabling Operation) and Shutting Down (Switching Off). - Voltage applied to the motor terminals.
5	QUICKSTOP ACTIVE	Emergency stop (Fast stop) is active
6	FAULT REACTION ACTIVE	The Drive is processing a trip event
7	FAULTED	The Drive is tripped awaiting trip reset

B-2 Sequencing Logic

Sequencing Diagram

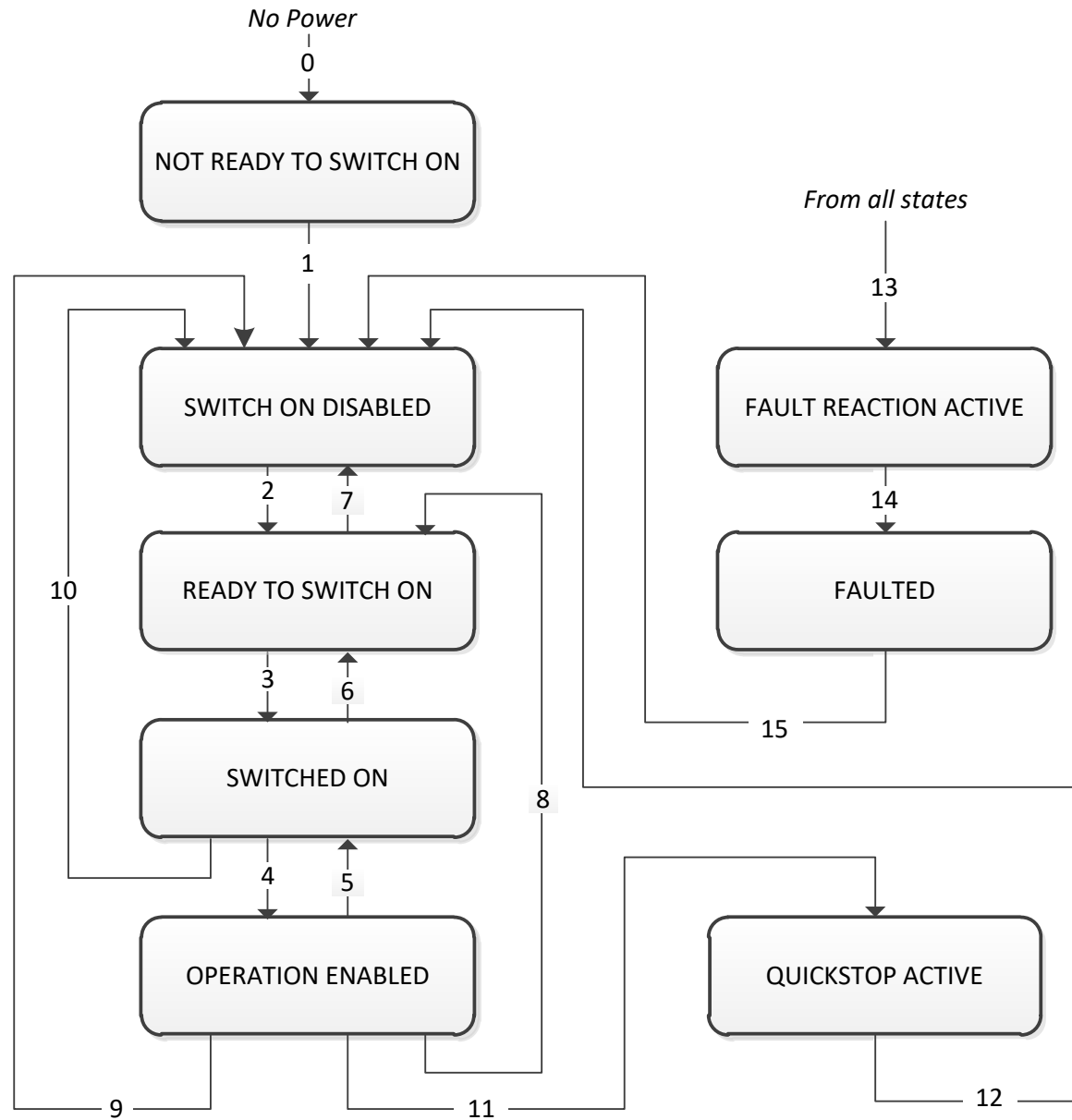

Sequencing Logic B-3

The OPERATION ENABLED state is the normal operation state of the Drive. In this state the Reference Ramp is active, generating a Speed Demand. Sub-states and allowed transitions are shown below. Note – the RUNNING sub-state also includes JOGGING.

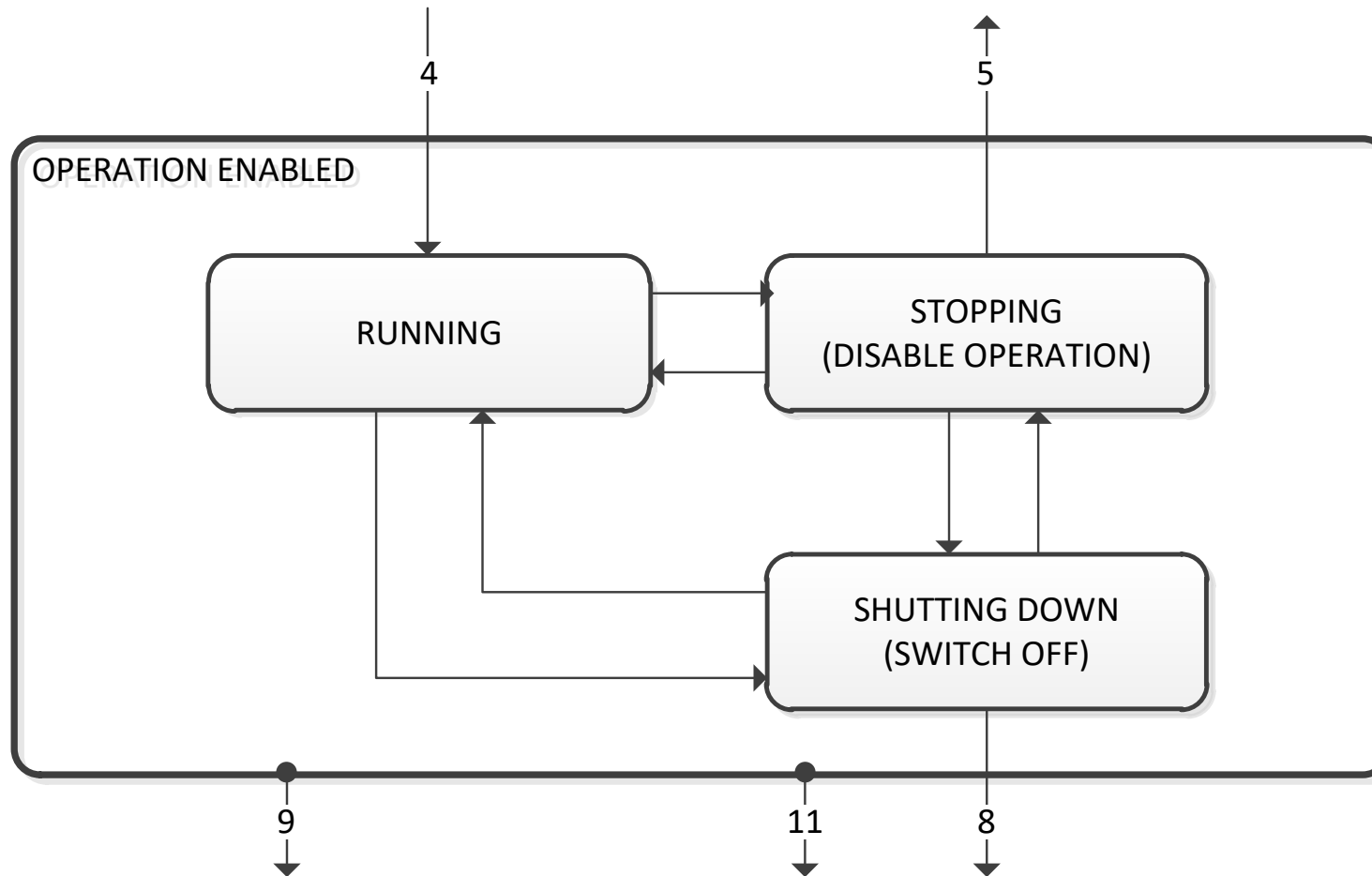

State Transitions

State transitions are caused by internal events in the Drive or external commands via the Control Word. The transition numbers below relate to those on the Sequence Diagram.

Transition 0: No Power to NOT READY TO SWITCH ON

Power has been applied to the control electronics of the drive.

B-4 Sequencing Logic

Transition 1: NOT READY TO SWITCH ON to SWITCH ON DISABLED

Automatic transition when initialisation has been completed and application has been loaded.

Transition 2: SWITCH ON DISABLED to READY TO SWITCH ON

Shutdown command received from control device or local signal.

Transition 3: READY TO SWITCH ON to SWITCHED ON

Switch On command received from control device or local signal.

Transition 4: SWITCHED ON to OPERATION ENABLED

Enable Operation (Run Forward, Run Reverse or Jog) command received from control device or local signal.

Transition 5: OPERATION ENABLED to SWITCHED ON

Disable Operation (Stop) command received from control device or local signal and Disabling (Stopping) function completed.

Transition 6: SWITCHED ON to READY TO SWITCH ON

Shutdown command received from control device or local signal.

Transition 7: READY TO SWITCH ON to SWITCH ON DISABLED

Quick Stop or Disable Voltage command received from control device or local signal.

Transition 8: OPERATION ENABLED to READY TO SWITCH ON

Shutdown command received from control device or local signal and Shutdown function completed.

Transition 9: OPERATION ENABLED to SWITCH ON DISABLED

Disable Voltage command received from control device or local signal.

Transition 10: SWITCHED ON to SWITCH ON DISABLED

Disable Voltage or Quick Stop command received from control device or local signal.

Transition 11: OPERATION ENABLED to QUICKSTOP ACTIVE

Quick Stop command received from control device or local signal.

Transition 12: OPERATION ENABLED to QUICKSTOP ACTIVE

Automatic transition when the Quick Stop function is completed or Disable Voltage command received.

Transition 13: any state to FAULT REACTION ACTIVE

Fault (Trip) occurred.

Transition 14: FAULT REACTION ACTIVE to FAULT

Automatic transition when Fault Reaction function completed or Disable Voltage command received.

Transition 15: FAULT to SWITCH ON DISABLED

Fault Reset command received from control device or local signal and there are no active faults.

Control Word

The commands that request a change in sequencer state are received via the Control Word. The current value is given by **0644 Control Word**. This is a read-only parameter which is updated from a source depending on the selected sequencing control channel. The sources available are COMMS, APP and LOCAL.

If COMMS is selected, the value will be taken from **0627 Comms Control Word**. This will normally be written to over either the Fieldbus interface or built-in Ethernet Modbus TCP. The Not Quickstop, Enable Voltage and Switch On bits are ANDed with **0610 App Control Word**. The External Fault is ORed with the **0610 App Control Word**.

If APP is selected, the value will be taken from **0610 App Control Word**. This will normally be written to by the loaded application which is responsible for routing the control signals from Digital Input terminals.

If LOCAL is selected, the value will be written to by the GKP with the Not Quickstop, Enable Voltage, External Fault and Switch On bits from **0610 App Control Word**.

Bit	Name	Description
0	Switch On	OFF1 = 1 to switch on
1	Enable Voltage	OFF2 = 0 to coast stop
2	Not Quickstop	OFF3 = 0 to emergency stop
3	Enable Operation	1 = Run
4	Enable Ramp Output	=0 to set ramp output to zero <i>Not implemented, See note below</i>
5	Enable Ramp	=0 to hold ramp <i>Not implemented, See note below</i>
6	Enable Ramp Input	=0 to set ramp input to zero <i>Not implemented, See note below</i>
7	Reset Fault	Reset trips on 0 to 1 transition
8	External Fault	1 = External (Application) trip active
9		<i>unused</i>
10	Use Comms Control	1 = Use 0627 Comms Control Word as the Control Word source for sequencing
11	Use Comms Reference	1 = Use 0681 Comms Reference as the Reference source
12	Use Jog Reference	1 = Run using 0501 Jog Setpoint when Enable Operation = 1
13	Reverse Direction	1 = Run in reverse direction when Enable Operation = 1
14	Auto Initialise	1 = Allow SWITCH ON DISABLED to READY TO SWITCH ON transition regardless of bit 0 (Switch On)
15	Event Triggered OP	1 = Rising-edge of Enable Operation required for SWITCHED ON to OPERATION ENABLED transition Setting "Event Triggered OP" to 0 could cause the motor to start unexpectedly.



Note – bits 4, 5, 6 must be set (= 1) to allow the ramp control feature to be added in the future.

B-6 Sequencing Logic

Example Comms Control Words (hexadecimal):

CC77 STOP (Normal) or go to SWITCHED ON state
 CC7F RUN
 CC7B QUICKSTOP
 CC7D COAST STOP
 CCF0 FAULT RESET

Status Word

The Status Word provides the detailed status of the sequencer. Regardless of the source of the Control Word, this is always available as **0661 Status Word**.

Bit	Name	Description
0	Ready To Switch On	Drive initialised and not in Configuration mode
1	Switched On	Drive in SWITCHED ON or OPERATION ENABLED state
2	Operation Enabled	Running (or stopping)
3	Faulted	Unacknowledged fault present
4	Voltage Enabled	Line supply present
5	Quickstop Inactive	= 0 when reacting to a Quickstop request
6	Switch On Disabled	Drive in SWITCH ON DISABLED state
7		<i>unused</i>
8		<i>unused</i>
9	Control From Comms	Using 0627 Comms Control Word as the Control Word source
10		<i>unused</i>
11		<i>unused</i>
12	Jog Operation	Using Jog Reference or will use Jog Reference when Operation Enabled
13	Reverse Operation	Running backwards or will run backward when Operation Enabled
14	Reference From Comms	Using 0681 Comms Reference as the Reference source
15	Stopping	Operation Enable command removed or Quickstop active

Appendix C: Parameter Reference

Parameter Descriptions

The parameter descriptions in this section are arranged alphabetically; however, they are also listed below by Category as on the GKP and web page. Engineer view level must be selected to see all the parameters listed under the Parameters menu.

Control Mode		Slew Rate	C-196	SNTP Server	C-198	Keypad Override	C-104
Control Mode	C-38	Slip Compensation	C-197	Web Server	C-228	Application	
Motor Control		Spd Direct Input	C-201	Option Comms		App Info	C-13
Auto Restart	C-15	Spd Loop Diagnostics	C-202	Communications Options	C-34	Minimum Speed	C-108
Autotune	C-20	Spd Loop Settings	C-203	Read Process	1	PID	C-124
Braking	C-27	Speed Ref	C-208	Write Process	1	Preset Speeds	C-153
Current Limit	C-43	Stabilisation	C-209	Event	1	Raise Lower	C-157
Current Loop	C-44	Stack Inv Time	C-210	Option Ethernet	1	Skip Frequencies	C-193
DC Link Volts Limit	C-51	Torque Limit	C-216	BACnet IP Option	C-24	System Board	
Energy Meter	C-64	Tr Adaptation	C-219	BACnet MSTP Option	C-25	System Board Option	C-214
Fan Control	C-68	Voltage Control	C-227	CANopen Option	C-29	SB Encoder	C-176
Feedbacks	C-69	Regen Control		ControlNet Option	C-42	SB Encoder Slot 1	C-179
Filter On Torque Dmd	C-74	AFE	C-2	DeviceNet Option	C-56	SB Encoder Slot 2	C-181
Fluxing VHz	C-78	Inputs And Outputs		EtherCAT Option	C-66	SB Retransmit	C-182
Flycatching	C-83	IO Configure	C-94	EtherNet IP Option	C-67	SB Digital IO	C-173
Induction Motor Data	C-90	IO Values	C-101	Modbus RTU Option	C-110	Phase Control	
Inj Braking	C-92	Option IO		Modbus TCP Option	C-111	Configure	C-35
Motor Load	C-112	IO Option Common	C-99	Profibus DP-V1 Option	C-155	Device Manager	
Motor Nameplate	C-115	General Purpose IO	C-85	Profinet IO Option	C-156	Device State	C-54
Motor Sequencer	C-117	Encoder	C-62	Trips		Device Commands	C-53
MRAS	C-118	Resolver	C-166	Trips Status	C-221	Drive info	C-57
Pattern Generator	C-121	Thermistor	C-215	Trips History	C-220	Clone	C-30
PMAC Flycatching	C-126	Base Comms		Stall Trip	C-213	Parameter Backup	C-120
PMAC Motor Advanced	C-128	Ethernet	C-67	VDC Ripple	C-226	Data Logger	C-46
PMAC Motor Data	C-129	Modbus	C-109	Current Sensor Trip	C-45	Flash File System	C-77
PMAC SVC	C-133	EtherNet IP Adapter	C-67	Speed Error Trip	C-207	SD Card	C-186
Pos Fbk Alignment	C-141	Profinet IO Device	C-156	Black Box Recorder	C-26	Real Time Clock	C-165
Power Loss Ride Thru	C-149	Fieldbus Mapping	C-73	Maintenance Monitor	C-106	Runtime Statistics	C-171
Ramp	C-159	Peer to Peer	C-123	Keypad		Setup Wizard	C-191
Scale Setpoint	C-185	Precision Time Protocol	C-152	Graphical Keypad	C-87	Soft Menus	C-199
Sequencing	C-187	SNTP Client	C-198	Local Control	C-105		

1. Refer to the appropriate fieldbus communications option.

For additional parameter details refer to the Parameter Table at the end of this appendix. The Parameter Number, (PNO), provided next to each parameter description may be used to find the corresponding entry in the Parameter Table.

C-2 Parameter Reference

Active Front End (AFE)

Control Screen

Setup:: Regen Control

Monitor:: Regen Control

Active Front End (AFE) is a mode of operation of the drive required for full 4-Q regeneration capabilities. AFE control mode allows a single AC30P/AC30D drive to act as a 4-Q power supply unit that is capable of drawing (motoring) and supplying (regenerating) sinusoidal, near-unity power factor current from the supply. The output from the 4-Q Regen drive acts as a DC supply which is used to power other drives on a common DC Bus system.

AFE Control Mode is available as a standard option in the AC30P/AC30D firmware, however set-up and installation requirements need to be adhered to in order to use a drive as 4-Q regen unit. These requirements are described in more detail in the paragraphs that follow.

Hardware Requirements

The figure below shows the typical installation configuration of the drive operating in AFE control mode.

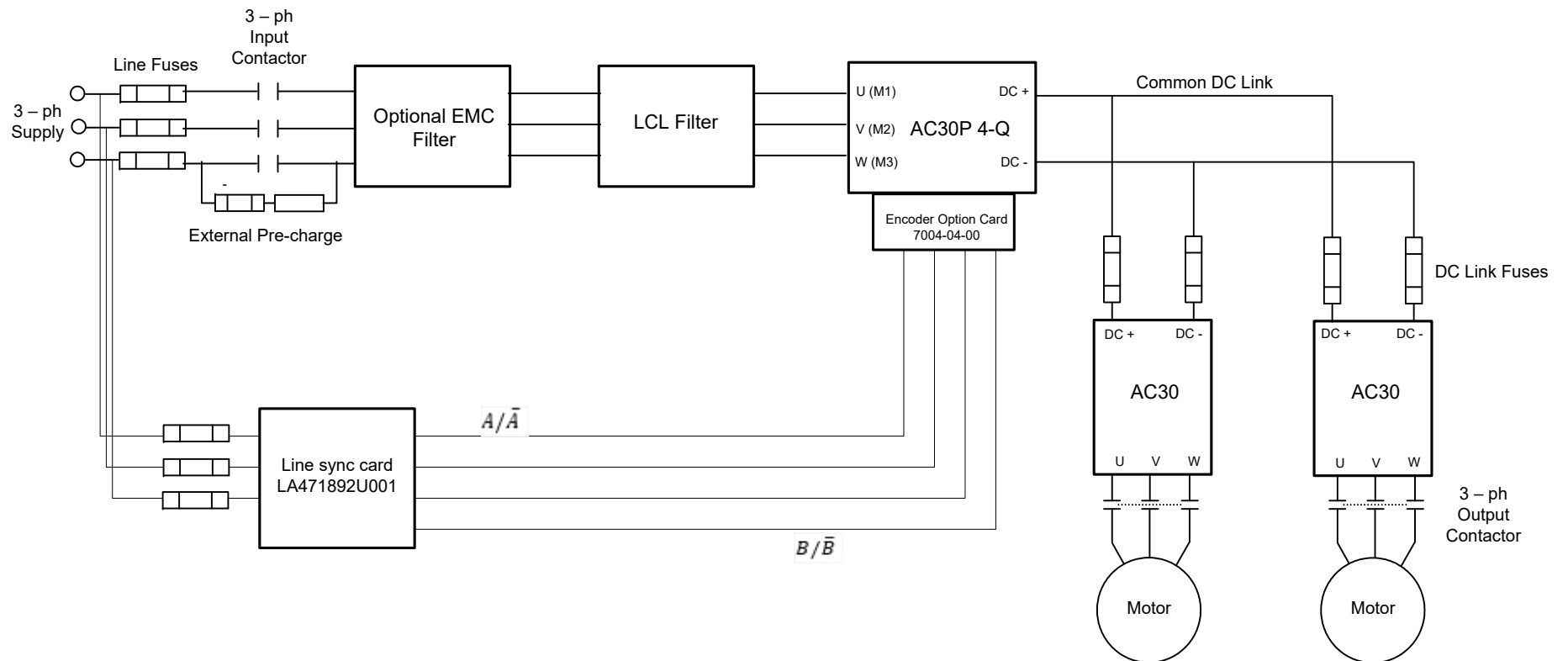

The correct installation requires the following components:

- LCL filter
 - o 3% and 5% chokes (as part of an LCL filter, custom designed)
 - o Capacitor panel (as part of an LCL filter, custom designed)
- Pre-charge resistor with external pre charge control
- Three phase contactors
- EMC filter (optional)
- AC Line fuses
- DC Link fuses
- Line sync card (LA471892U001)
- Encoder option card (7004-04-00)

Drive Set-up

Typically the system will contain an AC30P/AC30D regen drive providing 4-Q power supply, and one or more drives on the common DC bus.

ALL drives in the system **MUST** have their internal EMC “Y” caps to earth disconnected.

A 4-Q regen drive is set into AFE control mode by setting the **Control Mode “Motor Type or AFE”** parameter to AFE as shown in picture below.

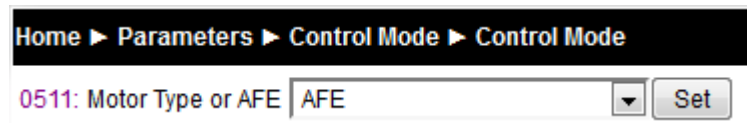

This setting must be accompanied by selection of an appropriate AFE macro from the default application:



If the “Motor Type or AFE” and “Selected Application” do not match, it would not be possible to operate the drive correctly. Both these settings are necessary for proper configuration of the drive to work as an active front end.

When drive is in AFE mode, its current rating is limited to 85% of the equivalent set up current rating when in one of the motor modes.

The standard set of AFE parameters required to finalise the drive AFE configuration are located within **Setup/Regen Control** menu. Based on the “AFE Current Control” bit, AFE would operate in voltage control mode (left), or current control mode (right):

C-4 Parameter Reference

Home ▶ Setup ▶ Regen Control		Home ▶ Setup ▶ Regen Control	
0511: Motor Type or AFE	AFE <input type="button" value="Set"/>	0511: Motor Type or AFE	AFE <input type="button" value="Set"/>
1730: AFE Inductance	6.70 mH <input type="button" value="Set"/>	1730: AFE Inductance	6.70 mH <input type="button" value="Set"/>
1711: AFE VDC Demand	720 V <input type="button" value="Set"/>	1693: AFE Current Control	<input checked="" type="checkbox"/> <input type="button" value="Set"/>
1693: AFE Current Control	<input type="checkbox"/> <input type="button" value="Set"/>	1705: AFE Iq Demand	0.00 <input type="button" value="Set"/>
1705: AFE Iq Demand	0.00 <input type="button" value="Set"/>	1704: AFE Id Demand	0.00 <input type="button" value="Set"/>

AFE inductance parameter must be set to the value of the total line choke inductance.

AFE VDC Demand parameter sets the required DC link voltage for the common DC link bus. Recommended level for nominal drive voltage rating of 400V (with 820V overvoltage trip level and 410V undervoltage trip level) is 720V.

AFE VDC Min Level parameter defines the level of DC link voltage at which external precharge closure is instigated. By default it is equal to undervoltage trip level.

For any additional adjustments (if required) the full set of the AFE related parameters can be found in the **Parameters::Regen Control::AFE** menu.

Home ▶ Parameters ▶ Regen Control ▶ AFE

Other (*non-AFE*) drives, supplied through common DC bus **MUST** have the following set-up:

DC Link volts limit feature disabled

Home ▶ Parameters ▶ Motor Control ▶ DC Link Volts Limit

1641: VDC Lim Enable

If in V/Hz mode the Terminal Voltage Mode parameter set to FIXED

Home ▶ Parameters ▶ Motor Control ▶ Voltage Control

0371: Terminal Voltage Mode

AFE Application

A standard AFE macro (App_5_AFE_Control) is included as part of the default application. It provides necessary application layer logic to operate in AFE control mode. This macro can be modified (if necessary) using standard AC30 PDQ or PDD tools. It enables the user immediate operation without any additional diagram logic wiring, providing that electrical connections to digital inputs and outputs are the same as in default AFE macro.

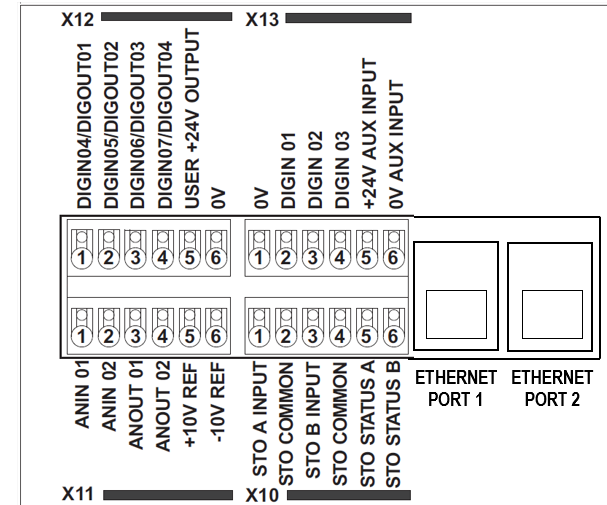
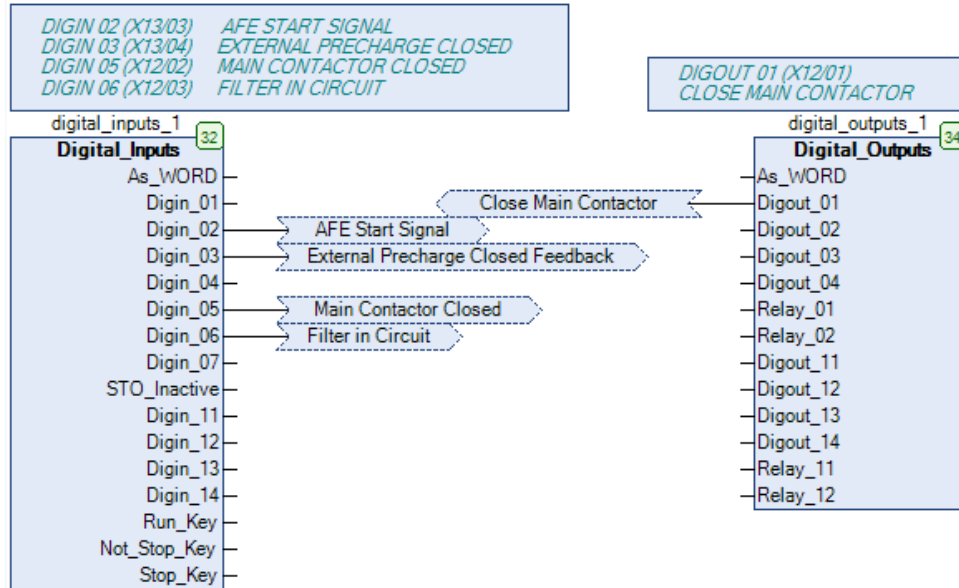

The default macro requires the following electrical wiring diagram for AC30P/AC30D control board. Use of different inputs will need to be accompanied by the appropriate change in the application.

Parameter Reference C-7

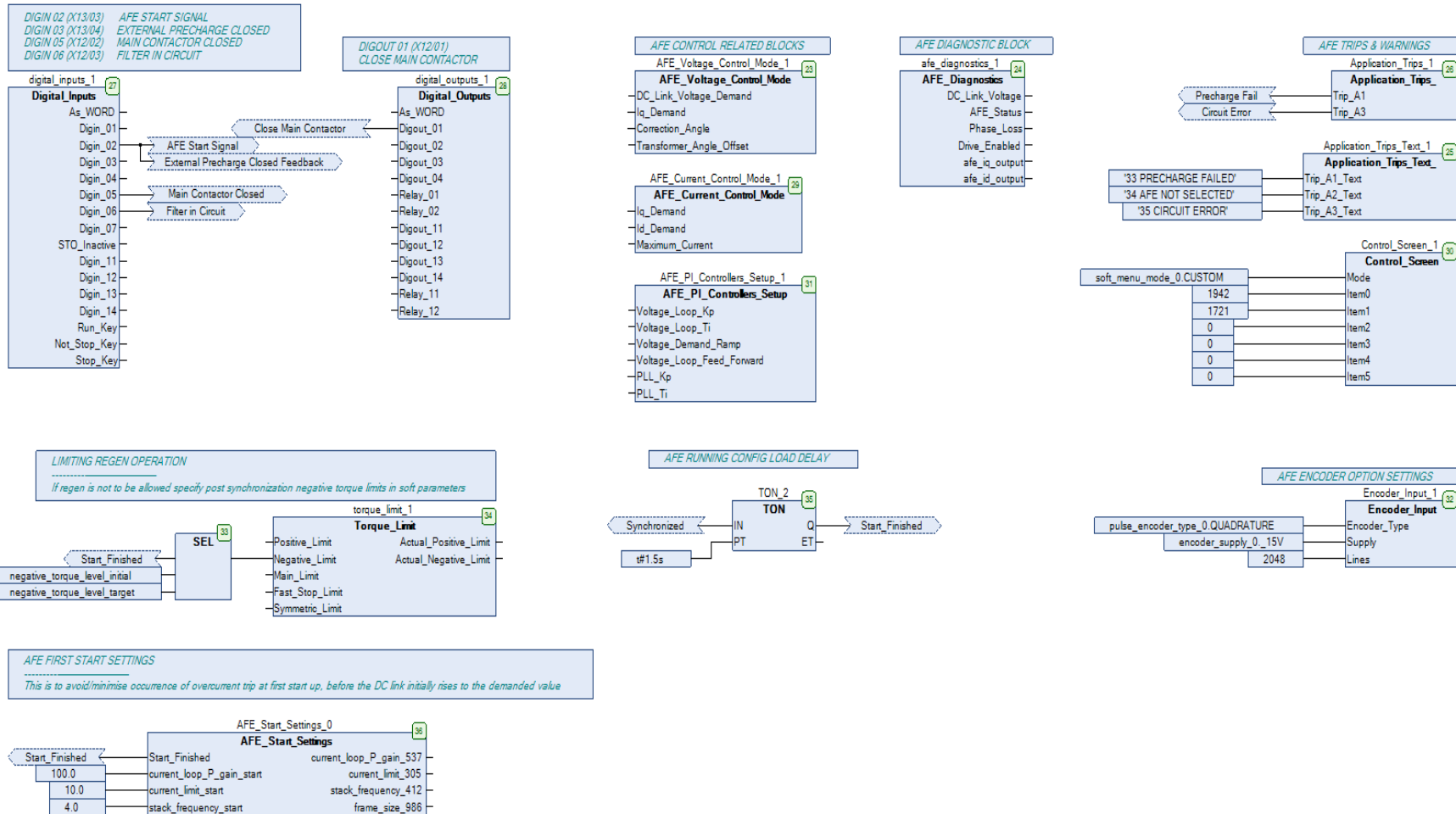

C-8 Parameter Reference

AFE Start Up Sequence

In order to minimise the potential occurrence of initial current transients when AFE is switched on, an “AFE Start Settings” block was included in the default macro. It works in conjunction with the following four soft parameters:

- 1943 AFE Current Limit
- 1944 AFE Current Loop P Gain
- 1945 AFE Stack Frequency
- 1946 AFE Default Stack Frequency

AFE Default Macro Setup Parameters

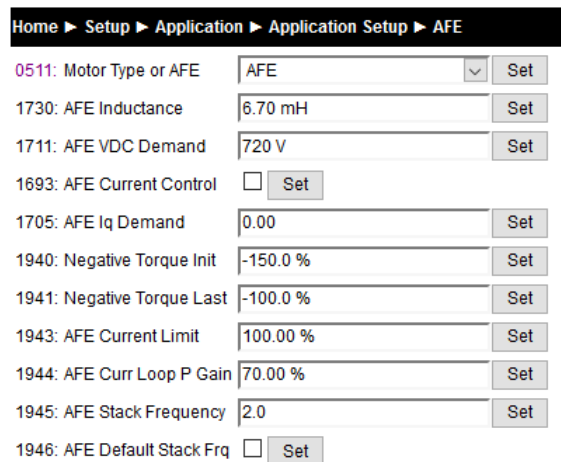

Parameter ID	Parameter Name	Value	Action
0511	Motor Type or AFE	AFE	Set
1730	AFE Inductance	6.70 mH	Set
1711	AFE VDC Demand	720 V	Set
1693	AFE Current Control	<input type="checkbox"/>	Set
1705	AFE Iq Demand	0.00	Set
1940	Negative Torque Init	-150.0 %	Set
1941	Negative Torque Last	-100.0 %	Set
1943	AFE Current Limit	100.00 %	Set
1944	AFE Curr Loop P Gain	70.00 %	Set
1945	AFE Stack Frequency	2.0	Set
1946	AFE Default Stack Frq	<input type="checkbox"/>	Set

These soft parameters have to be populated with the values that are required for operation in normal running mode, before first start of AFE mode is attempted!

Start up values are set as constants within the macro, and can only be changed by reprogramming AFE application into the drive. Soft parameter 1946 AFE Default Stack Frequency allows the user to specify if drive should operate (post start up) with its default switching frequency, or with a different one, as specified in soft parameter 1945.

It is, by default, set that start up is finished after 1.5 seconds since the run command has taken effect.

Line Synchronisation

Typically the system will contain an AC30P/AC30D regen drive providing 4-Q power supply, and one or more drives on the common DC bus. However, in order for the AFE control procedures to operate correctly, a synchronization of the IGBT firing sequence to the three phase mains supply voltage frequency, angle, and direction of rotation need to be performed. This is achieved by using a line sync card (LA471892U001), connected to a standard AC30 encoder option board (7004-04-00). Failure to successfully synchronise could cause significant supply distortion, poor power factor, or even catastrophic failure.

AFE Parameter List

The full set of AFE related parameters are given in a table below:

Parameter Name	No.	Path	Default	Range	Units	Writable
AFE Inductance	1730	Setup::Regen Control Parameters::Regen Control::AFE	0.00	0.00 to 1000.00	mH	ALWAYS
Total inductance (3% + 5%) from the LCL filter in the AFE configuration.						
AFE PF Angle Demand	1693	Parameters::Regen Control::AFE	0.00	-90.00 to 90.00	deg	ALWAYS
Sets AFE in current control mode (TRUE) or leaves it in voltage control mode (FALSE).						
AFE Id Demand	1705	Same as PNO 1693	0.10	-1.50 to 1.50		ALWAYS
Iq current demand. Set directly in both current control mode, or voltage control mode.						
AFE Id Demand	1704	Same as PNO 1693	0.10	-1.50 to 1.50		ALWAYS
Id current demand. Set directly only in current control mode. In voltage control mode set by dc link voltage loop.						
AFE Max Current	1706	Parameters::Regen Control::AFE	1.50	0.00 to 1.50		ALWAYS
Maximum allowed current in AFE mode.						
AFE Close Ext PCR	1690	Parameters::Regen Control::AFE	FALSE			ALWAYS
Link to digital output to send command to close external pre charge						

C-10 Parameter Reference

Parameter Name	No.	Path	Default	Range	Units	Writable
AFE Ext PCR Closed	1691	Parameters::Regen Control::AFE	FALSE			ALWAYS
Link to digital input to provide information if external pcr is closed.						
AFE Sync Frequency	1703	Monitor::Regen Control Parameters::Regen Control::AFE			Hz	NEVER
Mains frequency as measured by the AFE module.						
AFE Sync Angle	1718	Parameters::Regen Control::AFE			deg	NEVER
Mains angle as measured by the AFE module.						
AFE PLL Kp	1694	Parameters::Regen Control::AFE	5.48	0.00 to 30.00		ALWAYS
PLL proportional gain.						
AFE PLL Ti	1695	Parameters::Regen Control::AFE	0.0318	0.0000 to 3.0000		ALWAYS
PLL integral term.						
AFE VDC Kp	1707	Parameters::Regen Control::AFE	8.27	0.00 to 300.00		ALWAYS
DC link voltage loop proportional gain.						
AFE VDC Ti	1708	Parameters::Regen Control::AFE	0.0319	0.0000 to 3.0000		ALWAYS
DC link voltage loop integral term.						
AFE VDC Demand	1711	Same as PNO 1693	720	340 to 820	V	ALWAYS
DC link voltage demand, setpoint for voltage control loop.						

Parameter Reference C-11

Parameter Name	No.	Path	Default	Range	Units	Writable
AFE VDC Ramp	1709	Parameters::Regen Control::AFE	0.05	0.01 to 100.00	%	ALWAYS
DC link voltage ramp rate.						
AFE VDC Feed Forward	1710	Parameters::Regen Control::AFE	0.0000	-1.5000 to 1.5000		ALWAYS
DC link voltage loop feed forward term.						
AFE VDC Min Level	1697	Parameters::Regen Control::AFE	400.00	340.00 to 5000.00		ALWAYS
AFE healthy DC link level, for precharge control, if necessary to be set lower than undervoltage trip level.						
AFE Correction Angle	1717	Parameters::Regen Control::AFE	0.00	-90.00 to 90.00		ALWAYS
Angle correction offset.						
AFE Transf Angle Offset	1731	Parameters::Regen Control::AFE	0.00	0.00 to 360.00	deg	ALWAYS
Angular offset necessary due to (potential) transformer delta/star connections.						
AFE Synchronizing	1712	Parameters::Regen Control::AFE				NEVER
TRUE if AFE in synchronizing state.						
AFE Synchronized	1713	Parameters::Regen Control::AFE				NEVER
TRUE if AFE has synchronized to mains frequency.						
AFE Enable Drive	1714	Parameters::Regen Control::AFE				NEVER
Drive enabled to do AFE.						

C-12 Parameter Reference

Parameter Name	No.	Path	Default	Range	Units	Writable
AFE PF Angle Demand	1692	Parameters::Regen Control::AFE	0.00	-90.00 to 90.00	deg	ALWAYS
Power factor angle demand.						
AFE Phase Loss	1715	Parameters::Regen Control::AFE				NEVER
Indicates if phase loss occurred.						
AFE Brake Mode	1716	Parameters::Regen Control::AFE	FALSE			ALWAYS
Sets AFE control into brake mode.						
AFE Status	1721	Same as PNO 1703		0:INACTIVE 1:SYNCHRONIZING 2:SYNCHRONIZED 3:SUPPLY FREQ HIGH 4:SUPPLY FREQ LOW 5:SYNC FAILED		NEVER
AFE module status reporting.						

NOTES

1 – To correctly set up AFE mode for frame K

- phase fail trip needs to be disable in AFE mode
- parameter 1707 needs to be set at 0.75
- parameter 1708 needs to be set at 0.02

App Info

Parameters::Application::App Info

Details of the Application loaded in the Drive. An Application is built as part of a project using a suitable programming tool. When downloaded into the Drive an Application within the Project can be selected to run. Some Projects only contain a single Application, so in this case will always be selected.

Parameter Name	No.	Path	Default	Range	Units	Writable
Project File Name	1040	Parameters::Application::App Info				NEVER
The name of the file on the programming PC used to store the application. (This does not include the project or projectarchive file name extension.)						
Archive Flags	0410	Parameters::Application::App Info				NEVER
Indicates if the source code corresponding to the loaded configuration is saved in the drive as an archive. For the AC30V the this archive must be saved on the SD Card. On the AC30P the archive can be saved internally or on the SD Card.						
Bit 0 Indicates that the project archive file on the SD card matches the loaded application						
Bit 4 Indicates that the language file on the SD card for the selected language matches the loaded application						
Bit 8 Indicates that the project archive file stored internally matches the loaded application						
Last Modification	1047	Parameters::Application::App Info		1970/01/01 to 2038/01/19		NEVER
Timestamp of when the loaded Project was last modified. (Note - the RTC option is not required for this.)						
IDE Version	1048	Parameters::Application::App Info				NEVER
The version of programming tool (Interactive Development Environment) used to create the loaded Project.						
Project Author	1054	Parameters::Application::App Info				NEVER
<i>The Author of the loaded Project as entered in the programming tool when it was created</i>						
Project Version	1061	Parameters::Application::App Info				NEVER
<i>The Project version of the loaded Project as entered by the programmer when creating the Project.</i>						

C-14 Parameter Reference

Parameter Name	No.	Path	Default	Range	Units	Writable
Project Description	1068	Parameters::Application::App Info				NEVER
<i>A description of up to 80 characters entered by the programmer when creating the Project.</i>						
Application Name	1554	Parameters::Application::App Info				NEVER
<i>The name of the selected Application within the loaded Project.</i>						
Configuration Lock	0118	Parameters::Application::App Info	FALSE			ALWAYS
<i>Set TRUE to prevent the application being over-written from the configuration tool or from a clone file.</i>						

Auto Restart

Setup:: Motor Control::Auto Restart

Parameters::Motor Control::Auto Restart

The Auto Restart feature provides the facility to automatically reset a choice of trip events and restart the drive with a programmed number of attempts. The number of attempted restarts is monitored. A manual or remote trip reset is required if the drive is not successfully restarted within the maximum number of restarts. The purpose of this feature is to allow automatic recovery from trip conditions. This is especially useful on remote or unmonitored sites.

Parameter Name	No.	Path	Default	Range	Units	Writable
AR Enable	1469	Setup::Motor Control::Auto Restart Parameters::Motor Control::Auto Restart	FALSE			ALWAYS
Enables the auto restart function.						
AR Mode	1470	Same as PNO 1469	1	0:TRIP RESET 1:AUTO RESTART 2:AUTO START		ALWAYS
Defines the action that the AR function will take following a trip.						
<ul style="list-style-type: none"> 0. TRIP RESET Trips will be reset when the trip sources are inactive. The drive will not be restarted. 1. AUTO RESTART If it was running the drive will be restarted when the trip sources are inactive and run is active. 2. AUTO START The drive will be started when the trip sources are inactive if the run signal is high 						
Refer to the Functional Description below for more details.						
AR Max Restarts	1471	Same as PNO 1469	10	1 to 20		ALWAYS
Defines the maximum number of restart attempts permitted before the AR function disables itself.						

C-16 Parameter Reference

Parameter Name	No.	Path	Default	Range	Units	Writable
AR Trip Mask	1472	Same as PNO 1469	FFFFFFFF	0:01 OVER VOLTAGE		ALWAYS
				1:02 UNDER VOLTAGE		
				2:03 OVER CURRENT		
				3:04 STACK FAULT		
				4:05 STACK OVER CURRENT		
				5:06 CURRENT LIMIT		
				6:07 MOTOR STALL		
				7:08 INVERSE TIME		
				8:09 MOTOR I2T		
				9:10 LOW SPEED I		
				10:11 HEATSINK OVERTEMP		
				11:12 INTERNAL OVERTEMP		
				12:13 MOTOR OVERTEMP		
				13:14 EXTERNAL TRIP		
				14:15 BRAKE SHORT CCT		
				15:16 BRAKE RESISTOR		
				16:17 BRAKE SWITCH		
				17:18 LOCAL CONTROL		
				18:19 COMMS BREAK		
				19:20 LINE CONTACTOR		
				20:21 PHASE FAIL		
21:22 VDC RIPPLE						
22:23 BASE MODBUS BREAK						
23:24 24 V OVERLOAD						
24:25 PMAC SPEED ERROR						
25:26 OVERSPEED						
26:27 STO ACTIVE						
27:28 FEEDBACK MISSING						
28:29 INTERNAL FAN FAIL						
29:30 CURRENT SENSOR						
30:31 POWER LOSS STOP						
31:32 SPEED SENSOR						
AR Trip Mask 2	0796	Setup::Motor Control::Auto Restart Parameters::Motor Control::Auto Restart	FFFFFFFF	0:33 A1		ALWAYS
				1:34 A2		
				2:35 A3		
				3:36 A4		
				4:37 A5		
				5:38 A6		
				6:39 A7		
				7:40 A8		
				8:41 SPEED ERROR		
				9:42 PEERTOPEER OVERRUN		
				10:43 PHASE CONFIG		
				11:44 FIELD BUS BREAK		
				18:51 CPU USAGE		

Defines the trip causes that the AR feature will attempt to automatically reset, followed by an attempt to restart the drive if appropriate.

Refer to Chapter 7 “Trips and Fault Finding” for details of the value corresponding to each trip.

Parameter Reference C-17

Parameter Name	No.	Path	Default	Range	Units	Writable
AR Initial Delay	1505	Same as PNO 1502	10.000	0.000 to 3600.000	s	ALWAYS
<p>The time in seconds for which the AR feature will wait before attempting to restart the drive for the first restart attempt, (1509 AR Restarts Remaining equals 1471 AR Max Restarts). The delay time is started once all trips have become inactive.</p> <p>The delay time is ignored if the AR feature is configured to simply reset the trip without attempting to restart the motor.</p>						
AR Repeat Delay	1506	Same as PNO 1502	60.000	0.000 to 3600.000	s	ALWAYS
<p>The time in seconds for which the AR feature will wait before attempting to restart the drive for the second and subsequent restart attempts, (1509 AR Restarts Remaining is not equal to 1471 AR Max Restarts). The delay time is started once all trips have become inactive.</p> <p>The delay time is ignored if the AR feature is configured to simply reset the trip without attempting to restart the motor.</p>						
AR Trip Mask B	1734	Parameters::Motor Control::Auto Restart	00000000			ALWAYS
AR Trip Mask 2 B	1735	Parameters::Motor Control::Auto Restart	00000000			ALWAYS
AR Initial Delay B	1736	Parameters::Motor Control::Auto Restart	60.000	0.000 to 3600.000	s	ALWAYS
AR Repeat Delay B	1737	Parameters::Motor Control::Auto Restart	120.000	0.000 to 3600.000	s	ALWAYS
<p>The 'B' parameters define a second set of trips and associated restart delays. This set operates in parallel with the primary set. If a trip is enabled in both sets, the restart time associated with the primary set, (A), will apply.</p> <p>Typically use of the 'B' set of trips will be to configure some trips to cause a delayed restart action, while the primary set of trips may be acted on with a shorter delay.</p>						
AR Active	1507	Parameters::Motor Control::Auto Restart				NEVER
<p>Indicates that the AR feature will reset the trip source once all trips have become inactive, (following a delay time if the AR feature has been configured to also restart the motor).</p>						

C-18 Parameter Reference

Parameter Name	No.	Path	Default	Range	Units	Writable
AR Restart Pending	1508	Parameters::Motor Control::Auto Restart				NEVER
Indicates that the AR feature will reset the trip source and attempt to restart the motor once all trips have become inactive and the relevant delay timer has expired.						
AR Restarts Remaining	1509	Parameters::Motor Control::Auto Restart		0 to 20		NEVER
Indicates the number of restart attempts remaining before the AR feature disables itself. This count is reset to 1471 AR Max Restarts after a successful manual or remote trip reset. This includes any restart or trip reset performed due to the configuration taking some programmed action. The count is also reset after a period of trip free operation. This period is the longer of 5 minutes, or 5 * AR Repeat Delay B.						
AR Time Remaining	1510	Parameters::Motor Control::Auto Restart		0.000 to 3600.000	s	NEVER
Indicates the time remaining before a restart attempt will be made. This value starts to count down once all trip sources are inactive.						

Functional Description

The AR feature can be configured to operate in one of three modes via the parameter **1470 AR Mode**. In all modes the AR feature becomes active when the drive trips on one of the trips selected by one of the Trip Mask parameters. If the drive trips due to a trip not selected in one of these parameters the AR feature will remain in the idle state.

Setting parameter **1469 AR Enable** to FALSE will disable the AR feature regardless of its current state.

1470 AR Mode 0: Trip Reset

In Trip Reset mode, once the AR feature becomes active it monitors all possible trip sources. Once all trip sources are inactive the AR feature will attempt to reset the trip event, moving the Sequencing State from the FAULTED state, (see Appendix B: Sequencing Logic). The AR feature resets the trip as soon as possible, it does not wait for either **1505 Initial Delay** or **1506 AR Repeat Delay**. In this mode the AR feature will not attempt to restart the motor.

This mode may be used when an external supervisory system is monitoring the Faulted bit in **0661 Status Word**. This bit will be cleared once all trip sources are inactive and the trip has been successfully cleared, indicating that the drive may be started.



1470 AR Mode 1: *Auto Restart*

Caution: when Auto Restart is selected the motor may run unexpectedly.

In Auto Restart mode, once the AR feature becomes active it monitors all possible trip sources. Once all trip sources are inactive the AR feature starts the programmed delay. Once the delay timer expires the AR feature attempts to reset the trip and to restart the motor.

The AR feature will not restart the motor if it was not running at the time of the trip, nor will it restart the motor if the run signal has been removed at any time since the trip, (even if it is subsequently re-applied). When a motor restart will not be attempted the AR feature will act as if it had been configured for **Trip Reset** only. If a motor restart will be attempted the parameter **1508 AR Restart Pending** is set TRUE.

Each time a restart is attempted the value in **1509 Restarts Remaining** is decremented. Once this value reaches zero, any further trip selected for auto restart will cause the AR feature to disable itself.



1470 AR Mode 2: *Auto Start*

Caution: when Auto Start is selected the motor may run unexpectedly.

In Auto Start mode, once the AR feature becomes active it monitors all possible trip sources. Once all trip sources are inactive the AR feature starts the programmed delay. Once the delay timer expires the AR feature attempts to reset the trip and to restart the motor.

The AR feature will attempt to start the motor even if it was not running at the time of the trip, as long as the Sequencing Logic parameter **0644 Control Word** is configured to run, (typically bits 0, 1, 2 and 3 all set), see Appendix B: Sequencing Logic.

In this mode the parameter **1508 AR Restart Pending** is set TRUE. Each time a restart is attempted the value in **1509 Restarts Remaining** is decremented. Once this value reaches zero, any further trip selected for auto restart will cause the AR feature to disable itself.

Recovery from Self Disabled state

The AR feature will remain in the Self Disabled state indefinitely. It may be re-activated by the trip condition being reset by some other means, (ie. Manually by pressing the stop key on the GKP, or remotely using trip reset). Alternatively the AR feature may be re-enabled by setting **1469 AR Enable** to FALSE then back to TRUE.

Indication

When the AR feature is activated the parameter **1507 AR Active** is set TRUE.

While a restart is pending the parameter **1508 AR Restart Pending** is set TRUE. In addition the green LED illuminating the run key on the GKP will flash.

All indicators are reset once the restart, (or trip reset), attempt has been completed or if the AR feature is disabled.

C-20 Parameter Reference

Autotune

Setup:: Motor Control::Autotune

Parameters::Motor Control::Autotune

The autotune is an automatic test sequence performed by the Drive to identify motor model parameters. The motor model is used by the Vector control modes.

If an induction motor is used, and the control mode is set to vector control, you **MUST** perform an autotune before operating the Drive. If the control mode is set to Open Loop (V/Hz) mode an autotune is not necessary. Whether the drive is in Vector Control mode or in Open Loop mode is determined by the parameter 0512 Control Strategy in menu Control Mode (see page D-40). Induction motor nameplate parameters must be entered before running the autotune procedures in order for them to correctly measure motor model parameters.

The motor must be allowed to spin freely. It is acceptable for the motor to be connected to a load during autotune, provided that the load is purely inertia, with negligible friction, and does not require the motor to produce torque in order to turn.

If **stationary autotune** is selected in the **AC30V** variant, a parameter Nameplate Mag Current will appear. The user must enter the motor magnetising current into this parameter before proceeding with the stationary autotune. Stationary autotune in AC30V should be avoided if possible: first, because the magnetising current may not be accurate; second, because operation above base speed requires the rotating autotune to map the motor characteristics in the field weakening region, and if this is not done, operation may not be possible above base speed.

If **stationary autotune** is selected in the **AC30P/D** variant, a test procedure will be invoked that will attempt to calculate all the necessary motor model parameters from injected tests signals, without rotation. The success rate of this procedure during development has been around 80% (i.e. there were 20% of motors whose parameters were not successfully extracted by this method, and they couldn't be controlled in vector mode unless rotating autotuned was performed...), so its use has to be considered with caution. If there are practical difficulties performing rotating autotune with fully free motor shaft (e.g. gearbox, pump, compressor, lift, etc., already mounted) then stationary autotuned is to be attempted. However, if the obtained set of values does not result in a full, smooth speed or torque control, or if it isn't even sufficient to rotate the motor at all, a rotating autotune has to be performed. It is recommended that the stationary autotune is not used for the motors above 30kW. Also, if operation above base speed in the field weakening region is required, a rotating autotune needs to be performed.

If a permanent magnet motor is used and there is no datasheet available from your motor provider, You **MUST** perform an autotune before operating the Drive in the Vector control mode. Before running the autotune, some PMAC Motor parameters should be set. Some are available on the motor nameplate :

- **0555 PMAC Max Speed** :motor rated speed
- **0557 PMAC Rated Current** : motor rated current
- **0558 PMAC Rated Torque** : motor rated torque
- **1387 PMAC Base Volts** : motor voltage
- **0556 PMAC Max Current** : motor max current (if not known, set it to the same value as **0557 PMAC Rated Current**)
- **0559 PMAC Motor Poles** : motor number of poles (should be an even number)
- **0564 PMAC Motor Inertia** : motor inertia : try to set good estimated value, the speed loop will use it for setting correct control parameters

If a permanent magnet motor is used and there is datasheet available from your motor provider, You must either perform an autotune before operating the Drive in the Vector control mode or enter the required motor parameters from the datasheet.

If a permanent magnet motor is used, setting the **0412 Stack Frequency** to 4kHz or less will help to better estimate the motor resistance (**0562 PMAC Winding Resistance**).

For best results it is better to carry out the autotune at the maximum speed that is likely to be required. If you run the autotune at a particular speed, the motor characteristics will be measured up to this speed, and estimated above this speed. If you later discover that you need to run the motor faster than this, you can do this up to twice the speed at which the autotune is carried out, but the values will not be so accurate, and the control may not be as good in this region. It is better to run another autotune at the higher speed. If you wish to run the motor at more than twice the speed at which the autotune was carried out, this will not be allowed. If in doubt, the autotune speed is recorded in the parameter Max Spd When Autotuned, described below.

Parameter Name	No.	Path	Default	Range	Units	Writable
Autotune Enable	0255	Setup::Motor Control::Autotune Parameters::Motor Control::Autotune	FALSE			STOPPED
Puts the autotune feature into a state where it will carry out the autotune when the drive is started.						
Autotune Mode	0256	Same as PNO 255	1	0:STATIONARY 1:ROTATING		STOPPED
Selects whether the autotune is carried out on a rotating motor, or whether it just calculates from nameplate data (not the preferred method). It may be necessary to carry out a stationary autotune if the motor is not free to rotate, for example if it is already connected to a machine. Leakage inductance (to tune the current loop) and stator resistance may be measured when the motor is stationary, but other parameters can only be inferred from nameplate data. Use the rotating autotune where possible.						
Nameplate Mag Current	1550	Setup::Motor Control::Autotune Parameters::Motor Control::Autotune	0.88	0.01 to 1000.00	A	STOPPED
This parameter will only become visible if Autotune Mode = STATIONARY is selected.						
If you select stationary autotune, you must enter the motor magnetising current into this parameter before proceeding with the stationary autotune. If this is not known, it can be approximated from the motor rated current and the power factor, as motor current times $\sqrt{1 - PF^2}$.						
The value of mag current entered here will be copied into the magnetising current parameter in the Induction Motor Data menu. If a rotating autotune is run at a later date, it will be replaced with the more accurate value, and this parameter will be irrelevant.						
Autotune Test Disable	0257	Same as PNO 255	0000	0:Stator Resistance 1:Leakage Inductance 2:Magnetising Current 3:Rotor Time Constant 4:Encoder Direction		STOPPED
This is only valid for induction motor autotune						
Allows selected tests to be disabled (default all tests are carried out).						
Each test can be individually disabled by setting to TRUE.						

C-22 Parameter Reference

Parameter Name	No.	Path	Default	Range	Units	Writable
ATN PMAC Test Disable	1388	Setup::Motor Control::Autotune Parameters::Motor Control::Autotune	0000	0:Stator Resistance 1:Leakage Inductance 2:KE Constant		STOPPED
<p>This is only valid for Permanent magnet motor control</p> <p>Allows selected tests to be disabled (default all tests are carried out).</p> <p>Each test can be individually disabled by setting to TRUE.</p> <p><i>Bitfield Value : Test</i></p>						
Autotune Ramp Time	0274	Same as PNO 255	10.000	1.000 to 1000.000	s	STOPPED
<p>Sets the ramp up time to motor base speed during autotune.</p>						
ATN PMAC Ls Test Freq	1405	Same as PNO 1388	100.0	0.0 to 500.0	Hz	STOPPED
<p>This is only valid for Permanent magnet motor control</p> <p>Set up the test frequency for the leakage inductance autotune of the permanent magnet motor control0255 Autotune Ramp Time</p>						
Max Spd when Autotuned	1459	Parameters::Motor Control::Autotune	x.	-1 to 100000	RPM	NEVER
<p>This parameter records the value of the "100% speed in rpm" parameter at the time the autotune was carried out.</p> <p>"100% speed in rpm" determines the max speed at which the motor can be commanded to run. When the autotune is carried out, it can only measure the motor characteristics up to this speed. Beyond this speed, the motor characteristics are filled in according to the best possible estimate, but are not necessarily accurate.</p> <p>If at a later date the "100% speed in rpm" parameter is increased, then that will allow the motor to run in the region where the motor characteristics have been estimated, not measured. The further into this region the motor is allowed to run, the less accurate will be the motor characteristics and hence the control.</p> <p>The user is allowed to increase "100% speed in rpm" up to 2 times the value stored in "Max Spd when Autotuned". Beyond this it is considered that the resulting control inaccuracy may be unacceptable. In this case, an error will be generated. If the user wishes to run the motor more than 2 times the value at which it was autotuned, then he must carry out a new autotune at the higher speed.</p>						

Functional Description

IMPORTANT *You MUST carry out an Autotune if you intend to use the drive in vector control mode. If you are using it in Volts/Hz control an Autotune is not necessary.*

Autotune can only be initiated from the “stopped” condition. When the test is complete, the stack is disabled and Autotune Enable is set to FALSE.

Note Refer to the Chapter 6: Setup Wizard for details on how to perform an Autotune.

Standard Autotune

If an induction motor is fitted, the autotune will identify parameters as follows.

Parameter	Description	Note
MAG CURRENT	Magnetising current	Not measured by Stationary Autotune
STATOR RES	Per phase stator resistance	
LEAKAGE INDUC	Per phase stator leakage inductance	
MUTUAL INDUC	Per phase mutual inductance	
ROTOR TIME CONST	Rotor time constant	This will be identified while the motor is spinning, while measuring the magnetising current. If stationary autotune is selected, it will be identified from magnetising current and motor nameplate rpm

- ◆ The Rotating autotune sequence rotates the motor up to the user-programmed MAX SPEED (**Scale Setpoint** function) in order to identify these parameters. (A rotating autotune is required if the motor is to be operated above base speed).
- ◆ The Stationary autotune sequence does not rotate the motor and requires the correct value of MAG CURRENT to be entered. (Stationary Autotune should only be considered if rotating autotune is not possible to execute).

If a permanent magnet motor is fitted, the autotune will identify parameters as follows.

Parameter	Description	Note
STATOR RES	Phase to phase stator resistance	
LEAKAGE INDUC	Phase to phase stator leakage inductance	
KE CONSTANT	Back-emf constant	This will be identified while the motor is spinning. If stationary autotune is selected, it will be identified from motor nameplate parameters

- ◆ The Stationary autotune sequence does not rotate the motor and requires the correct permanent magnet nameplate value to be entered.
- ◆ The Rotating autotune sequence rotates the motor up to the half of the rated motor speed in order to identify these parameters.

C-24 Parameter Reference

BACnet IP Option

Monitor::Communications::Option

Setup::Communications::Option

Parameters::Option Comms::Comms

Parameters::Option Comms::Write Process

Parameters::Option Comms::Option Ethernet

Parameters::Option Comms::BACnet IP

[Refer to BACnet IP Technical Manual HA501939U001](#)

BACnet MSTP Option

Monitor::Communications::Option

Setup::Communications::Option

Parameters::Option Comms::Comms

Parameters::Option Comms::Write Process

Parameters::Option Comms::BACnet MSTP

[Refer to BACnet MSTP Technical Manual HA501940U001](#)

C-26 Parameter Reference

Black Box

Parameters::Trips::Black Box Recorder

The Black Box Recorder feature captures the state of the drive in the moments leading up to a trip, and at the moment of the trip. This data is saved in the drive's internal memory. The captured data may be transferred to an SD card for investigation.

Parameter Name	No.	Path	Default	Range	Units	Writable
Black Box PNOs[0]	1831	Parameters::Trips::Black Box Recorder	0829	0000 to 3145		ALWAYS
Black Box PNOs[1]	1832	Parameters::Trips::Black Box Recorder	0514	0000 to 3145		ALWAYS
Black Box PNOs[2]	1833	Parameters::Trips::Black Box Recorder	1022	0000 to 3145		ALWAYS
Black Box PNOs[3]	1834	Parameters::Trips::Black Box Recorder	0393	0000 to 3145		ALWAYS

Select up to four parameters that are recorded leading up to a trip along with the fixed set of data.

Copy to SD Card	1829	Parameters::Trips::Black Box Recorder	FALSE			ALWAYS
-----------------	------	---------------------------------------	-------	--	--	--------

When a usable SD Card is inserted in the drive, changing this parameter from FALSE to TRUE will start the process of copying the black box records from internal memory to the SD card. Each record is created as a separate file on the SD card.

Once started, the copy process will continue until all the records have been transferred, this can take up to a minute. To ensure that the ERROR status is correctly displayed, it is recommended that this value is left at TRUE until the copy has completed.

This parameter is not saved. It is initialised to FALSE when the drive powers on.

Copy Status	1852	Parameters::Trips::Black Box Recorder		0:IDLE 1:ACTIVE 2:DISABLED		NEVER
-------------	------	---------------------------------------	--	----------------------------------	--	-------

Indicates the status of the copy process. Once the copy is complete the status will return to IDLE. The ERROR status is cleared on changing the parameter "Clone to SD Card" back to FALSE.

Functional Description

Refer to chapter 7 "Trips and Fault Finding" for further information.

Braking

Parameters::Motor Control::Braking

The braking function controls the rate at which energy from a regenerating motor is dumped into a resistive load. This dumping prevents the dc link voltage reaching levels which would cause an Overvoltage trip.

Parameter Name	No.	Path	Default	Range	Units	Writable
Braking Enable	0249	Parameters::Motor Control::Braking	TRUE			ALWAYS
Enables operation of the dynamic braking feature.						
Brake Resistance	0251	Parameters::Motor Control::Braking	100.00	0.01 to 1000.00	Ohm	STOPPED
The value of the dynamic braking load resistance.						
Brake Rated Power	0252	Parameters::Motor Control::Braking	0.11	0.10 to 510.00	kW	STOPPED
The power that the load resistance may continually dissipate.						
Brake Overrating	0253	Parameters::Motor Control::Braking	25.00	1.00 to 40.00		STOPPED
Multiplier that may be applied to Brake Power for power overloads lasting no more than 1 second.						
Braking Active	0254	Parameters::Motor Control::Braking				NEVER
A read-only parameter indicating the state of the brake switch.						

Functional Description

When enabled, the **Braking** feature monitors the internal dc link voltage every millisecond and sets the state of the brake switch accordingly. When using braking, the brake resistor information must be entered it ordered for the resistor protection to operate.

The **Braking** feature operates even when the motor output is not enabled. This allows the function to continually monitor the energy dumped into the braking resistor, and the energy dissipated across the brake switch. With this information the Drive is able to deduce the loading on the brake resistor.

C-28 Parameter Reference

If the instantaneous braking power is greater than the Brake Rated Power parameter then this overload is accumulated. If the overload area (power excess x time) reaches the level set in the Brake Overrating parameter then the brake switch is automatically disabled. This can then lead to an overvoltage trip protecting the inverter.

The voltage level at which braking occurs is nominally 764V, but rises linearly to 773V as the overload area rises to the Brake Overrating limit. This improves the brake energy sharing in a multi-brake common d.c. bus system, which can be effected by variation in the exact braking voltage level in each inverter.

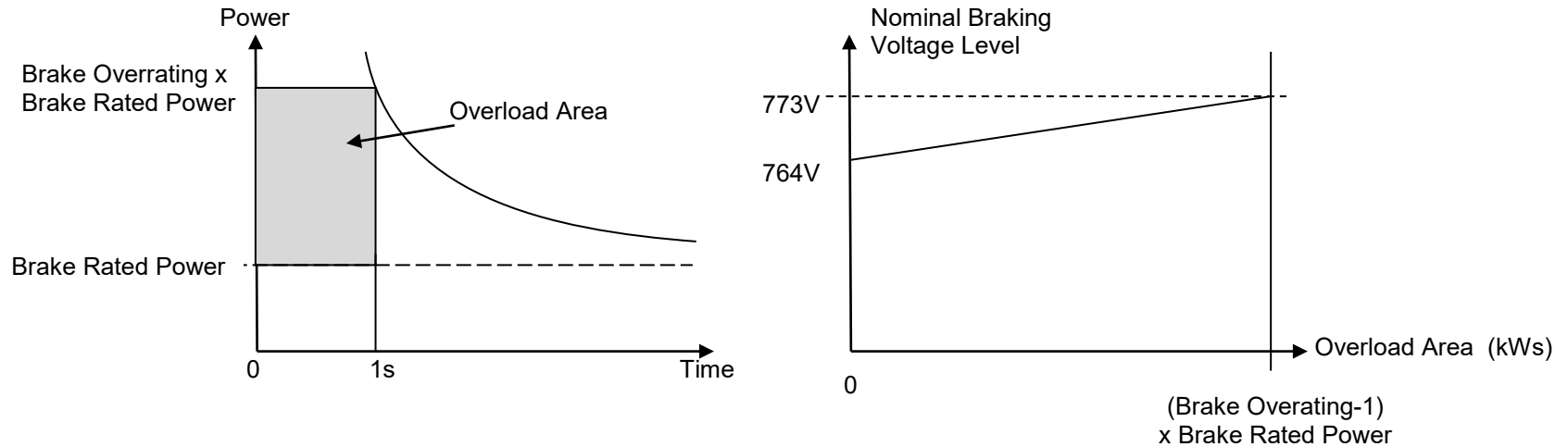

The **Braking** feature also provides a control signal that is used by the **Slew Rate** limit feature. This causes the setpoint to be temporarily frozen whenever the brake is operating because the dc link voltage exceeds the internal comparison level. This allows the stop rate to be automatically tuned to the characteristics of the load, motor, Drive and brake resistor.

CANopen Option

Monitor::Communications::Option

Setup::Communications::Option

Parameters::Option Comms::Comms

Parameters::Option Comms::Read Process

Parameters::Option Comms::Write Process

Parameters::Option Comms::Event

Parameters::Option Comms::CANopen

[Refer to CANopen Technical Manual HA501841U001](#)

C-30 Parameter Reference

Clone

Setup::Clone

Parameters::Device Manager::Clone

The clone feature allows the drive configuration (application and parameters) to be saved to an SD card and subsequently loaded to the same or a different drive.

All parameters fall into one of the following cloning categories listed in the parameter table at the end of this appendix:

- **Never:** This type of parameter would never be copied to a new drive. This category includes parameters that are not saved and parameters that contain information such as runtime statistics.
- **Drive Unique:** This type of parameter is normally unique to the drive, such as the drive name.
- **Power:** This type of parameter is related to the power stack of the drive or to the motor connected to the drive.
- **Other:** Any saved parameter that is not in the other cloning categories. This category is the majority of the parameters including the application parameters.

The visibility of the following cloning parameters on the GKP may depend on the selection of other cloning parameters and whether an SD card is fitted.

Parameter Name	No.	Path	Default	Range	Units	Writable
Clone Filename	1534	Setup::Clone Parameters::Device Manager::Clone	clone			ALWAYS

The filename used for saving or loading the clone file. The file extension for clone files is “.cln” and will be added to the filename if it is not provided by the user.

A single file contains the information for the parameters and the application.

Clone Direction	1537	Same as PNO 1534	0	0:SAVE TO FILE 1:LOAD FROM FILE		ALWAYS
------------------------	------	------------------	---	------------------------------------	--	--------

Sets whether a clone save or a clone load should be performed.

Parameter Name	No.	Path	Default	Range	Units	Writable
Full Restore	1538	Same as PNO 1534	0	0:YES 1:PARTIAL		ALWAYS

If the parameter **1537 Clone Direction** is set to LOAD FROM FILE, then the parameter **Full Restore** determines if a full restore or a partial restore is required from the file specified.

If YES is chosen then all the saved parameters and the saved application will be loaded including 'drive unique' parameters.

If PARTIAL is chosen then the user has the choice of what to restore, however 'drive unique' parameters will keep their current values. The following clone parameters apply:

1539 Application

1541 Power Parameters

1540 Other parameters

Notes:

If the power stack of the drive is different to the power stack from which the clone file was saved and the user chooses YES then the clone load will not be permitted. However the clone load will be permitted if the control module on which the user is restoring is not attached to a power stack, or if PARTIAL is chosen instead.

*The power parameters cannot be restored from a clone file that was saved on a control module with the parameter **0989 Power Stack Required** set to NONE.*

Application	1539	Same as PNO 1534	0	0:LOAD FROM FILE 1:LEAVE CURRENT APP		ALWAYS
--------------------	------	------------------	---	---	--	--------

If the parameter **1538 Full Restore** is set to PARTIAL, then the parameter **Application** allows the user to either load the application from the file or to leave the currently installed application.

Power Parameters	1541	Same as PNO 1534	0	Same as PNO 1540		ALWAYS
-------------------------	------	------------------	---	------------------	--	--------

If the parameter **1538 Full Restore** is set to PARTIAL, then the parameter **Power Parameters** allows the user to load the 'power' parameters from the file, leave the current values or set the values to the defaults.

Notes:

If the power stack of the drive is different to the power stack from which the clone file was saved and the user chooses LOAD FROM FILE then the clone load will not be permitted. However the clone load will be permitted if the control module on which the user is restoring is not attached to a power stack, or if LEAVE CURRENT VALUES or SET TO DEFAULT VALUES is chosen instead.

*The power parameters cannot be restored from a clone file that was saved on a control module with the parameter **0989 Power Stack***

C-32 Parameter Reference

Parameter Name	No.	Path	Default	Range	Units	Writable
Required set to NONE.						
<i>Enumerated Value : Power Parameters</i>						
0 : LOAD FROM FILE						
1: LEAVE CURRENT VALUES						
2 : SET TO DEFAULT VALUES						

Other Parameters	1540	Same as PNO 1534	0	0:LOAD FROM FILE 1:LEAVE CURRENT VALUES 2:SET TO DEFAULT VALUES		ALWAYS
-------------------------	------	------------------	---	---	--	--------

If the parameter **1538 Full Restore** is set to PARTIAL, then the parameter **Other Parameters** allows the user to load the 'other' parameters from the file, leave the current values or set the values to the defaults.

Enumerated Value : Power Parameters

Clone Start	1542	Same as PNO 1534	FALSE			ALWAYS
--------------------	------	------------------	-------	--	--	--------

When TRUE this parameter starts the cloning process, either saving or loading depending on the parameter **1537 Clone Direction**.

The cloning process will only start if the parameter **1543 Clone Status** is IDLE.

Once the cloning has completed the parameter **1543 Clone Status** will be DONE. Set the Clone Start parameter back to FALSE to return to the IDLE state.

Clone Status	1543	Same as PNO 1534		0:IDLE 1:SAVING 2:RESTORING 3:VERIFYING 4:DONE 5:CANNOT START 6:FAILED 7:NO SD CARD 8:VERIFY FAILED 9:FILE NOT OPENED 10:FILE INCOMPATIBLE 11:FILE FAILURE 12:POWER MISMATCH 13:APPLICATION FAILURE 14:PARAMETERS FAILURE 15:PNET SECTION MISSING 16: CARD FAULT		NEVER
---------------------	------	------------------	--	--	--	-------

Parameter Name	No.	Path	Default	Range	Units	Writable
This parameter indicates the status of the cloning process.						
<i>Enumerated Value :</i>						
	0.	IDLE	Waiting for the user to start the cloning process.			
	1.	SAVING	In the process of saving the drive configuration to file.			
	2.	RESTORING	In the process of loading the configuration from file.			
	3.	VERIFYING	In the process of verifying the clone file either before a load or after a save.			
	4.	DONE	The cloning process has completed successfully either for a load or a save.			
	5.	CANNOT START	The cloning process cannot start. When restoring a configuration the drive must be stopped.			
	6.	FAILED	General failure of the cloning process.			
	7.	NO SD CARD	No SD card is fitted.			
	8.	VERIFY FAILED	Could not restore the parameters. E.g. the parameters are missing from the clone file.			
	9.	FILE NOT OPENED	Could not open the file, possibly because the file is already open or the file name is incorrect.			
	10.	FILE INCOMPATIBLE	Source file was saved by a different major version of firmware, ie: AC30P version 2.x trying to read a file saved using version 1.x AC30V.			
	11.	FILE FAILURE	Unable to save to the clone file on the SD Card.			
	12.	POWER MISMATCH	Stack saved in the clone file is unknown to this drive.			
	13.	APPLICATION FAILURE	On a save, the application was not found. On a load the application was not recognized or could not be run.			
	14.	PARAMETERS FAILURE	Parameter data in the clone file is not in the expected format.			
	15.	PNET SECTION MISSING	Only relevant for Profinet build. The data containing the station name was not found.			
	16.	CARD FAULT	Problem with the SD card. Try a different type of SD card.			

Notes:

- 1) The clone file only contains the parameters that were stored in non-volatile memory on the drive when a clone save was performed. When performing a clone load and a full restore is performed or a LOAD FROM FILE is used for the parameters, then any parameter not previously saved in the file will be set to its defaults.
- 2) Each application parameter is restored only if the parameter definition on the target drive matches the saved parameter.
- 3) The clone saving process will take between 3 – 15 seconds depending on the type of SD card used.
- 4) When saving a file with the same filename as an existing file on the SD card, the existing file will be overwritten. To prevent this, use a PC to set the read-only attribute of the file.
- 5) During the clone loading process the GKP screen may blank momentarily.

C-34 Parameter Reference

Communications Options

Monitor::Communications::Option
Setup::Communications::Option
Parameters::Option Comms::Comms
Parameters::Option Comms::Event
Parameters::Option Comms::Read Process
Parameters::Option Comms::Write Process
*Parameters::Option Comms::Option Ethernet **

Refer to any of the following Technical Manuals:

Product Code	Description	Part Number
7003-PB-00	Profibus DP-V1	HA501837U001
7003-PN-00	PROFINET IO *	HA501838U001
7003-DN-00	DeviceNet	HA501840U001
7003-CN-00	ControlNet	HA501936U001
7003-CB-00	CANopen	HA501841U001
7003-IP-00	EtherNet IP *	HA501842U001
7003-EC-00	EtherCAT	HA501938U001
7003-BI-00	BACnet IP *	HA501939U001
7003-BN-00	BACnet MSTP	HA501940U001
7003-RS-00	Modbus RTU	HA501839U001
7003-IM-00	Modbus TCP *	HA501937U001

Configure, (Phase Control)

Parameters::Phase Control::Configure

Used to select Master and slave encoder source.

Gives a diagnostics of the configuration related to the encoder selection for the motor control, the Master (Reference) and the Slave.

Parameter Name	No.	Path	Default	Range	Units	Writable
Master Position Src	1745	Parameters::Phase Control::Configure	3	0:MAIN SPD FEEDBACK 1:SYSTEM BOARD SLOT 1 2:SYSTEM BOARD SLOT 2 3:NONE		STOPPED

Specifies the encoder to be used as the Master, (Reference) input :

- MAIN SPEED FEEDBACK: corresponds to the I/O feedback option
- SYSTEM BOARD SLOT 1: corresponds to the Slot 1 of the system board option
- SYSTEM BOARD SLOT 2: corresponds to the Slot 2 of the system board option
- NONE : no Master selected

Slave Position Src	1744	Parameters::Phase Control::Configure	0	0:SAME AS MOTOR FBK 1:MAIN SPD FEEDBACK 2:SYSTEM BOARD SLOT 1 3:SYSTEM BOARD SLOT 2 4:OTHER		STOPPED
--------------------	------	--------------------------------------	---	---	--	---------

Specifies the encoder to be used as the Slave input. Normally this will be the same as the speed feedback.

- SAME AS MOTOT FBK : the Slave encoder is the encoder used as the motor feedback.
- MAIN SPEED FEEDBACK : corresponds to the I/O feedback option
- SYSTEM BOARD SLOT 1 : corresponds to the Slot 1 of the system board option
- SYSTEM BOARD SLOT 2 : corresponds to the Slot 2 of the system board option

By default, the value SAME AS MOTOT FBK is selected.

If the Slave and the Motor Feedback are the same encoder, use SAME AS MOTOT FBK, otherwise, an error 301 or 302 or 303 will occur : Motor speed feedback and position feedback (slave) cannot be the same.

Setup Successful	1749	Parameters::Phase Control::Configure				NEVER
------------------	------	--------------------------------------	--	--	--	-------

The configuration of the master, slave and Speed loop encoders is correct

C-36 Parameter Reference

Parameter Name	No.	Path	Default	Range	Units	Writable
Error Number	1750	Parameters::Phase Control::Configure		-32768 to 32767		NEVER
<p>Indicates the nature of the fault giving an error</p> <ol style="list-style-type: none"> 0. No error. SetUpSuccessful is TRUE 1. Feedback vector mode selected, but speed feedback source set to NONE 2. Encoder feedback requested via the I/O option encoder board, but no hardware is fitted. 3. Encoder feedback requested via System Board Encoder Slot1, but no system board is fitted. 4. Encoder feedback requested via System Board Encoder Slot2, but no system board is fitted. 5. Reference encoder requested via the I/O option encoder board, but no hardware is fitted. 6. Reference encoder requested via System Board Encoder Slot1, but no hardware is fitted. 7. Reference encoder requested via System Board Encoder Slot2, but no system board is fitted. 8. Position loop feedback requested via the I/O option encoder board, but no hardware is fitted. 9. Position loop feedback requested via System Board Encoder Slot1, but no system board is fitted. 10. Position loop feedback requested via System Board Encoder Slot2, but no system board is fitted. 101. Conflict between selected motor speed feedback and position reference (cannot be the same!) : I/O option encoder board 102. Conflict between selected motor speed feedback and position reference (cannot be the same!) : System Board Encoder Slot1 103. Conflict between selected motor speed feedback and position reference (cannot be the same!) : System Board Encoder Slot2 201. Conflict between selected position reference and position feedback (cannot be the same!) : I/O option encoder board 202. Conflict between selected position reference and position feedback (cannot be the same!) : System Board Encoder Slot1 203. Conflict between selected position reference and position feedback (cannot be the same!) : System Board Encoder Slot2 301. Conflict between selected motor speed feedback and position feedback (cannot be the same!) : I/O option encoder board 302. Conflict between selected motor speed feedback and position feedback (cannot be the same!) : System Board Encoder Slot1 303. Conflict between selected motor speed feedback and position feedback (cannot be the same!) : System Board Encoder Slot2 						
Master Encoder	1751	Parameters::Phase Control::Configure		0:EMPTY FUNC 1:ESTIMATOR 2:PRIMARY 3:SYSTEM BOARD SLOT 1 4:SYSTEM BOARD SLOT 2 5:OTHER		NEVER
<p>Diagnostic giving the encoder set up as the master encoder</p> <ul style="list-style-type: none"> • SB SLOT1 • SB SLOT2 • PRIMARY (I/O option encoder board) 						
Slave Encoder	1752	Parameters::Phase Control::Configure		Same as PNO 1751		NEVER
<p>Diagnostic giving the encoder set up as the slave encoder</p> <ul style="list-style-type: none"> • SB SLOT1 • SB SLOT2 • PRIMARY (I/O option encoder board) 						

Parameter Name	No.	Path	Default	Range	Units	Writable
Spd Loop Encoder	1753	Parameters::Phase Control::Configure		Same as PNO 1751		NEVER

Diagnostic giving the encoder set up for the speed loop control

- SB SLOT1
 - SB SLOT2
 - PRIMARY (I/O option encoder board)
-

C-38 Parameter Reference

Control Mode

Setup:: Motor Control::Control & Type:: Control Strategy
Parameters::Motor Control::Control & Type::Control Strategy

The control mode block provides the means for selecting the type of motor and the desired method of controlling the motor.

Parameter Name	No.	Path	Default	Range	Units	Writable
Motor Type or AFE	0511	Setup::Motor Control::Control and Type Setup::Regen Control Parameters::Control Mode::Control Mode	0	0:INDUCTION MOTOR 1:PMAC MOTOR 2:AFE		STOPPED
<p>Motor type selection parameter</p> <p>Allows the user to select the type of motor.</p>						
Control Strategy	0512	Setup::Motor Control::Control and Type Parameters::Control Mode::Control Mode	0	0:VOLTS - HERTZ CONTROL 1:VECTOR CONTROL		STOPPED
<p>This parameter will only become visible if an induction motor is selected. If a PMAC motor is selected, the Control Strategy will automatically be set to Vector Control.</p> <p>Select control strategy selection parameter.</p> <p>Allows the user to select the method of controlling the motor.</p>						
Control Type	1533	Setup::Motor Control::Control and Type Parameters::Control Mode::Control Mode	0	0:SENSORLESS 1:ENCODER FEEDBACK		STOPPED
<p>This parameter will only become visible if Control Strategy is set to Vector Control. If the encoder option is not fitted, selecting ENCODER FEEDBACK will give a trip.</p> <p>This parameter allows selects between sensorless control, and control using encoder feedback.</p> <p>If an encoder feedback is available, it would normally be the preferred choice as it gives better speed control and higher performance.</p>						
Encoder Feedback	1743	Setup::Motor Control::Control and Type Parameters::Control Mode::Control Mode	0	0:MAIN SPD FEEDBACK 1:SYSTEM BOARD SLOT 1 2:SYSTEM BOARD SLOT 2 3:NONE		STOPPED

This parameter will only become visible if Control Strategy is set to Vector Control and Control Type is set to Encoder Feedback, and the drive is

Parameter Name	No.	Path	Default	Range	Units	Writable
<p>an AC30P/D</p> <p>The parameter selects between encoder inputs :</p> <p>MAIN SPD FEEDBACK : encoder option fitted or resolver option fitted. It corresponds to the option fitted in the I/O options. If selected, the I/O option has to be set up in the corresponding option (Resolver or Encoder)</p> <p>SYSTEM BOARD SLOT 1 : encoder connected on SLOT1 if AC30D encoder connected on AC30A</p> <p>SYSTEM BOARD SLOT 2 : encoder connected on SLOT 2 if AC30D</p> <p>NONE : no encoder connected – corresponds to SENSORLESS control selected</p> <p>If an encoder is available, encoder feedback control would normally be the preferred choice as it gives better speed control and higher performance.</p>						
Startup Alignment	1885	Setup::Motor Control::Control and Type Parameters::Control Mode::Control Mode	0	0:DISABLED 1:ONCE 2:ALWAYS		ALWAYS
<p>Only available for PMAC motor if Encoder Feedback control type selected.</p> <p>0:DISABLED : Start up alignment feature disabled. No action.</p> <p>1: ONCE : Start up alignment run once from a cold start state.</p> <p>At the end of the sequence, the drive is in Full Closed loop Vector control. A position Offset has been calculated and set up in 1808 PMAC Encoder Offset parameter.</p> <p>Only a trip condition will reset the system to run again the sequence.</p> <p>Changing this value will also reset the system and will cause the drive to run again the sequence on the next start.</p> <p>2: ALWAYS : At each motor start (Torque OFF to Torque ON condition), the drive goes through the Pseudo PMAC sequence and a new position offset is calculated, which will remain valid until next Torque OFF condition.</p>						
Actual Control Type	1886	Monitor::Motor and Drive Parameters::Control Mode::Control Mode		Same as PNO 1533		NEVER
<p>Only visible for PMAC motor if Encoder Feedback control type selected.Default: Equals to Control Type</p> <p>While the sequence is running, gives the drive actual control type.</p>						
Start Align Done	1887	Same as PNO 1886				NEVER

C-40 Parameter Reference

Parameter Name	No.	Path	Default	Range	Units	Writable

Only available for PMAC motor if Encoder Feedback control type selected.

Only appears if Startup Alignment set to ONCE.

Set to TRUE when the method has been run successfully.

Reset to FALSE after a cold start and/or a trip condition.

Functional Description

The motor selection is the first step in setting the control mode.

The selection of control strategy comes next, with the permitted settings as follows:

- Induction motors can be run in either volts hertz mode or vector mode
- Permanent magnet motors can only be run in vector control mode

If vector control is selected, and an encoder option or a resolver option is fitted, it is then necessary to choose whether to select vector control with encoder feedback for improved performance.

Pseudo PMAC control

To make the PMAC control compatible with incremental encoder type (pulse encoder, sin-cos, etc) which does not give absolute position information, a Virtual Zero Position needs to be determined, creating a position offset which changes the incremental encoder position to an absolute encoder position. After either a drive OFF or a trip condition situation, this offset is no longer valid and should be extracted again.

The method to align the encoder to the motor back EMF uses the AC30V Sensorless Vector Control motor scheme to start the motor (the meaning of 'to align' is determine the Virtual Zero Position). The absolute motor position is estimated by the sensorless control when the motor is turning. At least, reaching a motor speed of 5% is needed to have a good estimation of the absolute position. (5% is the default and recommended threshold value to move from a VHz motor control to a sensorless closed loop control mode in the actual AC30V sensorless Vector Control mode)

Once the motor is rotating at a higher speed than the threshold value, a position offset is calculated. This position offset is then used in real Closed Loop Vector Control. The incremental position from the encoder is now processed as an absolute position.

The method should be enabled if the drive is in speed control mode. (In torque control mode, the method won't give correct and accurate position offset).

The method is run until the final state :

Parameter Reference C-41

- if the speed setpoint is set to a higher value than 5% (the speed threshold appearing in the PMAC SVC block). A time out of 5s allows to trip if the estimated speed stays below 5%.

If the speed setpoint is set to a lower value than 5%, then the drive stays in open loop (VHZ) as long as the setpoint is kept below 5%.

- If the speed from the estimator is the same sign as the speed from the encoder feedback. If not, the drive trips.
- If the speed value from the estimator and the speed from the actual encoder feedback follow the same gradient. Considering a speed error between speed estimator and speed feedback of less than 0.5 Hz (Electrical speed) as a target provides a good criterion.

If not, a time out of 1s allows to trip the drive.

Because of timing constraint, especially when the pwm frequency is set to a high value (8kHz for high speed motors), **the method will force the pwm to run at 4kHz, no random pattern.**

C-42 Parameter Reference

ControlNet Option

Monitor::Communications::Option

Setup::Communications::Option

Parameters::Option Comms::Comms

Parameters::Option Comms::Read Process

Parameters::Option Comms::Write Process

Parameters::Option Comms::Event

Parameters::Option Comms::ControlNet

[Refer to ControlNet Technical Manual HA501936U001](#)

Current Limit

Parameters::Motor Control::Current Limit

Designed for all Motor Control Modes

This function allows you to set the maximum level of motor rated current (as a % of the user-set **Motor Current**) which is allowed to flow before current limit action occurs. If the measured motor current exceeds the current limit value with a motoring load, the motor speed is reduced to control the excess load. If the measured motor current exceeds the current limit value with a regenerating load, the motor speed is increased up to a maximum of **100% Speed in RPM (Scale Setpoint)**.

The maximum value of current limit for a particular motor is limited by the AC30V current rating.

If a motor of larger rating than the AC30V is connected, then the current limit max value is limited by the AC30V current rating.

If a motor of lower rating than the AC30V is connected, then the current limit max value is limited to 300% (if compatible with the AC30V current rating) for an induction motor (IM) and to the ratio **PMAC Max Current to PMAC Rated Current** for a PMAC motor.

% are always expressed as % of the user set **Motor Current** (rated current of PMAC or IM Motor).

Parameter Name	No.	Path	Default	Range	Units	Writable
Current Limit	0305	Setup::Motor Control::Control and Type Parameters::Motor Control::Current Limit	150.0	0.0 to 600.0	%	ALWAYS

This parameter sets the level of motor current, as a % of **Motor Current** (refer to the relevant MOTOR definition , PMAC or IM function) at which the Drive begins to take current limit action.

Regen Limit Enable	0307	Parameters::Motor Control::Current Limit	TRUE			ALWAYS
---------------------------	------	--	------	--	--	--------

This parameter enables or disables regenerative current limit action.

Note that this parameter only works in open-loop VOLTS / Hz motor control mode.

Functional Description

Internal limit : output of the Stack Inv Time module + reduction as a function of electrical low speed (< 3Hz) and as function of heatsink temperature



C-44 Parameter Reference

Current Loop

Setup:: Motor Control::Control & Type:: Motor Type

Parameters::Motor Control::Control Loop

Parameter Name	No.	Path	Default	Range	Units	Writable
Enable Predict Term	0955	Parameters::Motor Control::Current Loop	TRUE			ALWAYS

To enable the predictive term of the current loop.

Functional Description

This is to add the predictive term into the voltage demand formulated by the current regulator so to to increase the dynamic performance of motor drive. It is recommended to enable this parameter if the permanent magnet motor is used.

Current Sensor Trip

Parameters::Trips::Current Sensor Trip

This function contains parameters associated to the missing current sensor detection and trip condition

Parameter Name	No.	Path	Default	Range	Units	Writable
Current Diff Level	1658	Parameters::Trips::Current Sensor Trip	25.00	0.00 to 100.00	%	ALWAYS

The percentage of motor rated current which, if exceeded by difference between RMS values of two current sensor measurements, causes this trip to become active. This trip detects missing, or broken connections in the current sensing circuitry that result in loss of measurement of one sensor. Enabled in V/Hz mode of operation only.

C-46 Parameter Reference

Data Logger

Parameters::Device Manager::Data Logger

Regularly log the value of the selected parameters to the SD Card

Parameter Name	No.	Path	Default	Range	Units	Writable
Log Enable	1835	Parameters::Device Manager::Data Logger	FALSE			ALWAYS
Set to TRUE to enable the data logger						
Log Period	1836	Parameters::Device Manager::Data Logger	1.000	0.500 to 86400.000	s	ALWAYS
Defines the period between each set of data. The maximum value is equivalent to 24 hours.						
Log File Name	1837	Parameters::Device Manager::Data Logger	logfile_			ALWAYS
Defines the first characters of the log file name. The Data Logger automatically appends this name with a 4 digit sequence number and the extension “.csv”.						
Log to New File	1838	Parameters::Device Manager::Data Logger	FALSE			ALWAYS
On a change from FALSE to TRUE the Data Logger creates a new log file and starts saving data to this. The log file sequence number is automatically incremented each time a new file is created. If TRUE when Log Enable is set to TRUE then a new log file will be created. This parameter is not saved.						
Log New File On Reset	1839	Parameters::Device Manager::Data Logger	FALSE			ALWAYS
If TRUE the Data Logger will create a new log file each time the drive is powered up.						
Log Now	1868	Parameters::Device Manager::Data Logger	FALSE			ALWAYS
When data logging is enabled, a change from FALSE to TRUE forces a log record to be captured and written.						

Parameter Reference C-47

Parameter Name	No.	Path	Default	Range	Units	Writable
Limit Log File Size	1840	Parameters::Device Manager::Data Logger	FALSE			ALWAYS
<p>When TRUE the data logger limits the maximum log file size to 10 M Bytes. When this size is reached the Data Logger creates a new log file and starts saving data to this. The log file sequence number is automatically incremented each time a new file is created.</p>						
Log Parameters[0] to Log Parameters[7]	1843 to 1850	Parameters::Device Manager::Data Logger	0000	0000 to 3145		ALWAYS
<p>Defines up to 8 parameters to log. The list of parameters may be extended in the application by adding the Data_Logger_Int and / or the Data_Logger_Real blocks, see below.</p>						
Log File Size	1841	Parameters::Device Manager::Data Logger				NEVER
<p>The size of the currently active log file. This may be used in the application together with “1836 Log to new File” to force the Data Logger to create a new log file when the current file reaches an arbitrary size. This value is zero when 1835 Log Enable is FALSE.</p>						

Functional Description

The Log file is designed to be easy to read in either a text editor or a spreadsheet application, such as Microsoft Excel. The file format has the extension “csv” which stands for Comma Separated Variables.

Once each period, the drive records the nominated parameter values and writes these to a line in the log file. The data values are separated by columns, and the line is terminated with a carriage return line feed.

C-48 Parameter Reference

Below is an example configuration for the Data Logger.

Home ► Parameters ► Device Manager ► Data Logger Refresh

1835: Log Enable Set

1836: Log Period Set

1837: Log File Name Set

1838: Log to New File Set

1839: Log New File On Reset Set

1840: Limit Log File Size Set

1868: Log Now Set

1842: Log Parameters -

000: Set

001: Set

002: Set

003: Set

004: Set

005: Set

006: Set

007: Set

1841: Log File Size

The first few rows of the log file corresponding to this setting would be:

```
Serial Number,123456789012345
Date and Time,Notes,392 DC Link Voltage,393 Actual Speed RPM,406 CM Temperature,407 Heatsink Temperature,,,,,
2016/02/20 10:19:20.279,Continuation,643.6444,0.0000,31.0000,60.0364,,,,,
2016/02/20 10:19:21.274,,643.6700,0.0000,31.0000,60.0397,,,,,
2016/02/20 10:19:22.274,,643.7726,0.0000,31.0000,60.0397,,,,,
2016/02/20 10:19:23.274,,643.6445,0.0000,31.0000,60.0429,,,,,
2016/02/20 10:19:24.279,,643.6444,0.0000,31.0000,60.0405,,,,,
```

When viewed in Excel the data is organized into columns:

	A	B	C	D	E	F
1	Serial Number	123456789012345				
2	Date and Time	Notes	392 DC Link Voltage	393 Actual Speed RPM	406 CM Temperature	407 Heatsink Temperature
3	20/02/2016 10:19:20.279	Continuation	643.6444	0	31	60.0364
4	20/02/2016 10:19:21.274		643.67	0	31	60.0397
5	20/02/2016 10:19:22.274		643.7726	0	31	60.0397
6	20/02/2016 10:19:23.274		643.6445	0	31	60.0429
7	20/02/2016 10:19:24.279		643.6444	0	31	60.0405

- Row 1 The control module serial number
- Row 2 column headings
- Row 3... Time stamp, Notes and the data points.

Time stamp

The Time stamp format depends whether the parameter **1186 Time and Date** is valid and updating. This will typically be the case if an option with a Real Time Clock is fitted. It is also possible to keep this parameter valid over Ethernet. If the time and date is valid the time stamp will be in the format illustrated above. To display this format correctly in Excel it may be necessary to force the format of this column to be Custom, using this format string: "dd/mm/yyyy hh:mm:ss.000".

If the time and date value is not valid, the time stamp will be the age of the control card, expressed as a value in seconds with three decimal places, (giving resolution to one milli-second).

Notes

The notes column indicates a log event. The notes are:

Note	Description
Power On	Power has been applied to the control module.
Log Start	Log Enable changed from FALSE to TRUE.
Continuation	A new log file has been created due to: <ul style="list-style-type: none"> changing 1838: Log to New File from FALSE to TRUE file size exceeding 10 MB and 1840: Limit Log File Size is TRUE.
Changed setup	A change to one or more of the selected parameters to log. This also causes a new log file to be created.
New file name	A change to the file name, causing a new log file to be created.

Data values

The output data values are organized into columns with a header in row 2 indicating the parameter number and name. The values are output in a format determined by the parameter data type. String data types are not supported. Enumerated data types are output as integers, with 0 corresponding to the first enumeration in the list.

C-50 Parameter Reference

Extending the list of parameters

If it is necessary to log more than 8 parameters then the number of parameters to be logged may be increased to 40 in total, (an additional 32), by adding the Data_Logger_Int and / or the Data_Logger_Real blocks. The variables to be logged are to be gathered into an array of Long Integers, or an array of Reals and attached to the logger blocks, as illustrated here:

The screenshot shows a PLC programming environment with a variable declaration block and a corresponding ladder logic diagram. The variable declaration block is as follows:

```
1 PROGRAM Prog
2 VAR
3   DataLoggerReal : Data_Logger_Real;
4   RealArray : ARRAY[0..32] OF REAL := [1.1, 2.2, 3.3, 4.4, 5.5, 6.6, 7.7, 8.8, 9.9, 10.1, 11.11, 12.12, 13.13, 14.14, 15.15, 16.16,
5     17.17, 18.18, 19.19, 20.20, 21.21, 22.22, 23.23, 24.24, 25.25, 26.26, 27.27, 28.28, 29.29, 30.30, 31.31, 32.32, 33.33];
6   DataLoggerInt : Data_Logger_Int;
7   IntArray : ARRAY[0..32] OF DINT := [-1, 2, -3, 4, -5, 6, -7, 8, -9, 10, 11, 12, 13, 14, 15, 16, 17, 18, 19, 20, 21, 22, 23, 24, 25, 26, 27, 28, 29, 30, 31, 32, 33];
8 END_VAR
```

The ladder logic diagram shows two rungs. The first rung has a normally open contact labeled 'RealArray' connected to a coil labeled 'ADR 1'. The coil is connected to a block labeled 'Data_Logger_Real' (2). The 'Data_Logger_Real' block has two inputs: 'RealArrayAddr' and 'RealArrayLength'. The 'RealArrayLength' input is connected to a coil labeled '8'. The second rung has a normally open contact labeled 'IntArray' connected to a coil labeled 'ADR 0'. The coil is connected to a block labeled 'Data_Logger_Int' (3). The 'Data_Logger_Int' block has three inputs: 'IntArrayAddr', 'IntArrayLength', and 'IntType'. The 'IntArrayLength' input is connected to a coil labeled '14'. The 'IntType' input is connected to a coil labeled 'DATA_LOGGER_INT_TYPE_SIGNED'.

Here, the RealArray and IntArray variables are initialized with values, but in practice the values will be updated from application variables and fixed parameter values as part of the application program.

DC Link Volts Limit**Parameters::Motor Control::DC Link Volts Limit**

This function prevents over-voltage faults occurring due to a rapidly changing setpoint.

Parameter Name	No.	Path	Default	Range	Units	Writable
VDC Lim Enable	1641	Parameters::Motor Control::DC Link Volts Limit	FALSE			STOPPED
<p>enable DC Link Volts Limit during a fast deceleration to prevent overvoltage trip</p>						
VDC Lim Level	1642	Parameters::Motor Control::DC Link Volts Limit	91.0	78.0 to 100.0	%	STOPPED
<p>Determines the dc link volts at which the DC Link Volts Limit sequence is started. Entered as a percentage of the max DC link voltage (drive overvoltage level = 100%).</p>						
VDC Lim Active	1643	Parameters::Motor Control::DC Link Volts Limit				NEVER
<p>Set True when the deceleration ramp is paused in order to limit the DC link voltage</p>						
VDC Lim Output	1644	Parameters::Motor Control::DC Link Volts Limit	x.x	Min to Max	Hz	NEVER
<p>This diagnostic represents the speed setpoint output of the DC Link Volts limit Feature in Electrical Hz</p>						

C-52 Parameter Reference

Functional Description

During a fast deceleration, the kinetic energy of the motor load is regenerated to the drive, charging the DC link capacitors. When the **VDC Lim Level** is reached, the speed setpoint is held, waiting for the DC link to go below **VDC Lim Level**. When the DC link falls below this level, the speed setpoint is released and is ramped down using system ramp deceleration. This sequence is run until the speed setpoint reaches the user speed demand.

By Default, **VDC Lim Level** is set to the same value as the braking threshold.

This feature is run at a rate of 1 milli-second.

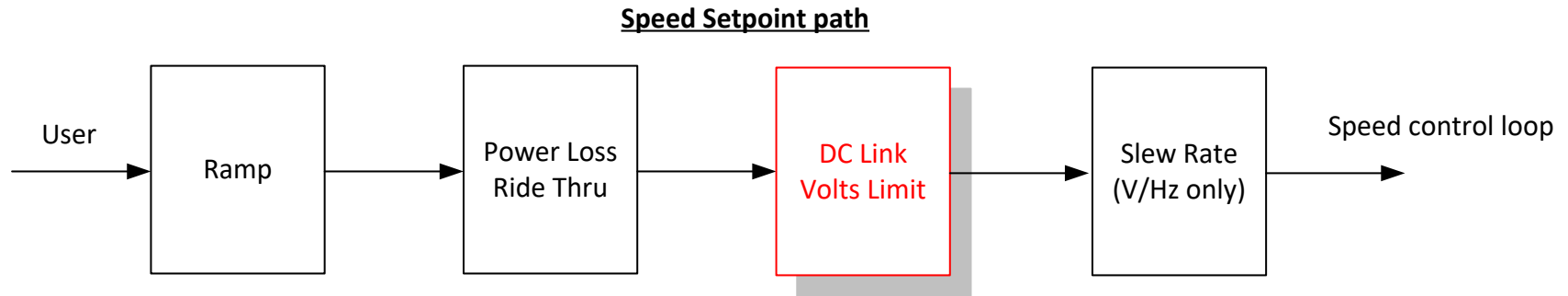

Device Commands

Parameters::Device Manager::Device Commands

Parameter Name	No.	Path	Default	Range	Units	Writable
Update Firmware	1002	Parameters::Device Manager::Device Commands	FALSE			STOPPED

This parameter is only visible when an SD card with a firmware update file is inserted into the drive. Changing this parameter to TRUE will start the firmware update procedure.

Following a firmware update it is advisable to power re-run the Setup Wizard, D-61

Save All Parameters	1001	Parameters::Device Manager::Device Commands	FALSE			ALWAYS
----------------------------	------	---	-------	--	--	--------

When a parameter is modified via the GKP or via the built-in web page the parameter value is saved automatically. When a parameter is modified via another source, (for example via the Modbus TCP/IP communications protocol), the value will not be saved automatically. In this case a save may be instigated by changing this parameter from FALSE to TRUE.

C-54 Parameter Reference

Device State

Parameters::Device Manager::Device State

Parameter Name	No.	Path	Default	Range	Units	Writable
Target State	0988	Parameters::Device Manager::Device State		3:PREOPERATIONAL 7:OPERATIONAL		STOPPED
<p>The requested operating state. This may be set from the Web Page or GKP. The PDQ configuration tool changes the operating state of the drive using a different mechanism.</p>						
Actual State	0989	Parameters::Device Manager::Device State		0:INITIALISING 1:INITIALISED 2:PREPARING PREOP 3:PREOPERATIONAL 4:PREPARING OP 5:FAILED TO READY 6:READY FOR OP 7:OPERATIONAL 8:FAULTED 9:FATAL ERROR RECOVER		NEVER
<p>Reports the actual operating state of the drive.</p>						
Application FE State	0990	Parameters::Device Manager::Device State		Same as PNO 989		NEVER
Base IO FE State	0991	Parameters::Device Manager::Device State		Same as PNO 989		NEVER
Basic Drive FE State	0992	Parameters::Device Manager::Device State		Same as PNO 989		NEVER
Ethernet FE State	0993	Parameters::Device Manager::Device State		Same as PNO 989		NEVER
Keypad FE State	0994	Parameters::Device Manager::Device State		Same as PNO 989		NEVER
Comms Option FE State	0995	Parameters::Device Manager::Device State		Same as PNO 989		NEVER

Parameter Name	No.	Path	Default	Range	Units	Writable
IO Option FE State	0996	Parameters::Device Manager::Device State		Same as PNO 989		NEVER
System Board FE State	1742	Parameters::Device Manager::Device State		Same as PNO 989		NEVER

The parameters above indicate the state of individual components, (or Functional Elements), within the drive. They may help with fault finding if the drive ever fails to enter the normal Operational state.

Config Fault Area	0997	Parameters::Device Manager::Device State		0:NONE 1:POWER STACK 2:OPTION IO 3:OPTION COMMS 4:APPLICATION 5:MOTOR CONTROL 6:KEYPAD 7:BASE COMMS 8:BASE IO 9:FEEDBACK MISSING 10:SYSTEM BOARD		NEVER
--------------------------	------	--	--	--	--	-------

Indicates which component within the drive is preventing the drive from entering the normal Operational state.

RTA Code	0998	Monitor::Trips Parameters::Device Manager::Device State				NEVER
-----------------	------	--	--	--	--	-------

Run Time Alert fault code, indicates a fault in the hardware or configuration, typically detected during power on initialization. Refer to chapter 7, Trips and Fault Finding.

RTA Data	0999	Same as PNO 998				NEVER
-----------------	------	-----------------	--	--	--	-------

Data associated with a Run Time Alert.

C-56 Parameter Reference

DeviceNet Option

Monitor::Communications::Option

Setup::Communications::Option

Parameters::Option Comms::Comms

Parameters::Option Comms::Read Process

Parameters::Option Comms::Write Process

Parameters::Option Comms::Event

Parameters::Option Comms::ControlNet

[Refer to DeviceNet Technical Manual HA501840U001](#)

Drive info**Setup::Environment****Parameters::Device Manager::Drive info**

Parameter Name	No.	Path	Default	Range	Units	Writable
Drive Name	0961	Setup::Environment Parameters::Device Manager::Drive info				ALWAYS
A string value that may be used to identify this drive in a system.						
Firmware Version	1100	Parameters::Device Manager::Drive info				NEVER
The version of the firmware running in the Control Module.						
Boot Version	0951	Parameters::Device Manager::Drive info				NEVER
The version of the boot loader firmware running in the Control Module, presented as a text string.						
Boot Version Number	0687	Parameters::Device Manager::Drive info				NEVER
The version of the boot loader firmware running in the Control Module.						
Auto Defaults	1869	Parameters::Device Manager::Drive info	FALSE			ALWAYS
<p>This parameter interacts with PNO 0976 Nominal Supply, and PNO 0987 Power Stack Required. When Auto Defaults is TRUE, changing either of these parameters from the GKP or Web page will cause their child parameters to be set to the corresponding defaults. The child parameters for PNO 0976 Nominal Supply are shown below, the child parameters for PNO 0987 Power Stack Required are shown in the table of Power Dependent Parameter Defaults at the end of this appendix.</p> <p>When TRUE, this parameter also controls the operation of the drive on Power up when the Control Module is attached to a new stack. If the new stack has a different power rating from the previously connected to stack, then "Power Stack Required" will automatically be set to match the new stack, the child parameters will be set to their default values, and these parameters will be saved in non-volatile memory if PNO1738 "Enable Auto Save" is TRUE.</p>						

C-58 Parameter Reference

Parameter Name	No.	Path	Default	Range	Units	Writable
Nominal Supply	0976	Parameters::Device Manager::Drive info	0	0:50 Hz 1:60 Hz		STOPPED

Defines the default supply frequency. In the GKP Setup Wizard, this parameter controls the default values for this child parameters:

PNO	Parameter	50Hz	60Hz
0464	100% Speed in RPM	1500	1800
0456	Base Voltage	400	460
0457	Base Frequency	50	60
0459	Nameplate Speed	1450	1750

When this parameter is changed from the GKP or Web page when PNO1869 “Auto Defaults” is TRUE then the child parameters are set to their corresponding default values, (and saved if PNO1738 “Enable Auto Save” is TRUE).

Power Stack Required	0987	Parameters::Device Manager::Drive info	0	Same as PNO 543		CONFIG
-----------------------------	------	--	---	-----------------	--	--------

The rating of the power electronics for the configuration loaded in the drive. This controls the default value for the child parameters listed in the Power Dependent Parameter Defaults table at the end of this appendix.

If 0987 Power Stack Required is different from 0543 Power Stack Fitted the drive will be prevented from running until the configuration is corrected.

If Power Stack Required is set to NONE, then it is automatically reset to match Power Stack Fitted on the next power on. This does not automatically modify any of the child parameters. To do this, set PNO 1869 Auto Defaults to TRUE.

Power Stack Fitted	0543	Parameters::Device Manager::Drive info		0:NONE 1:3.5 A 400 V 2:4.5 A 400 V 3:5.5 A 400 V 4:7.5 A 400 V 5:10.0 A 400 V 6:12.0 A 400 V 7:16.0 A 400 V 8:23.0 A 400 V 9:32.0 A 400 V 10:38.0 A 400 V 11:45.0 A 400 V R1 ⁽¹⁾ 12:60.0 A 400 V R1 ⁽¹⁾ 13:73.0 A 400 V R1 ⁽¹⁾ 14:87.0 A 400 V 15:105 A 400 V		NEVER
---------------------------	------	--	--	---	--	-------

Parameter Name	No.	Path	Default	Range	Units	Writable
				16:145 A	400 V	
				17:180 A	400 V	
				18:205 A	400 V	
				19:260 A	400 V	
				20:45.0 A	400 V	
				21:60.0 A	400 V	
				22:73.0 A	400 V	
				23:315 A	400 V	
				24:380 A	400 V	
				25:440 A	400 V	
				26:530 A	400 V	
				27:590 A	400 V	
				28:650 A	400 V	
				29:700 A	400 V	
				30:790 A	400 V	
				31:45.0 A	400 V r3 ⁽²⁾	

The rating of the power stack that the Control Module is fitted to. When the Control Module not attached to a stack this parameter is not visible and is ignored.

1. The Power Stack names ending in “R1” are for the initial release of Frame G stacks with ventilation holes in the casing. Later revisions of the Frame G stacks have no ventilation holes but have an internal cooling fan.
2. The 45 A “r3” stack is a repackaged 45 A stack in a frame F, (previous 45 A stacks were frame G).

Attached to Stack	0695	Parameters::Device Manager::Drive info	NEVER
--------------------------	------	--	-------

A Boolean parameter that indicates that the Control Module is attached to a power stack. When the Control Module is not attached to a stack but is powered using the auxiliary 24v input this parameter will indicate FALSE.

Stack Pcode	1109	Parameters::Device Manager::Drive info	NEVER
--------------------	------	--	-------

The product code string that may be used to order an equivalent Power Stack.

Stack Serial No	1258	Parameters::Device Manager::Drive info	NEVER
------------------------	------	--	-------

The serial number of the Power Control Card, (part of the Power Stack assembly).

Control Module Pcode	1116	Parameters::Device Manager::Drive info	NEVER
-----------------------------	------	--	-------

The product code string that may be used to order an equivalent Control Module, excluding options.

C-60 Parameter Reference

Parameter Name	No.	Path	Default	Range	Units	Writable
Control Module Serial	0977	Parameters::Device Manager::Drive info				NEVER
The serial number of the Control Module.						
Comms Option Pcode	1121	Parameters::Device Manager::Drive info				NEVER
The product code string that may be used to order an equivalent Communications Option, (only visible when a Communications Option is selected).						
Comms Option Serial	1129	Parameters::Device Manager::Drive info				NEVER
The serial number of the fitted Communications Option, (only visible when a Communications Option is selected).						
IO Option Pcode	1125	Parameters::Device Manager::Drive info				NEVER
The product code string that may be used to order an equivalent IO Option, (only visible when an IO Option is selected).						
IO Option Serial No	1134	Parameters::Device Manager::Drive info				NEVER
The serial number of the fitted IO Option, (only visible when an IO Option is selected).						
IO Option SW Version	1254	Parameters::Device Manager::Drive info				NEVER
For intelligent IO options this parameter shows the version of the firmware running in the option.						
Drive Diagnostic	0688	Parameters::Device Manager::Drive info		0:OK 1:STACK NOT CONNECTED 2:STACK DATA CORRUPT 3:UNKNOWN STACK 4:STACK MISMATCH		NEVER
Indicates the health of the drive configuration. When the drive configuration includes a mutually conflicting requirement, this parameter indicates the problem; for example, it attempting to run in Closed Loop Vector control mode when no feedback option is configured.						

Parameter Name	No.	Path	Default	Range	Units	Writable
Product Code Flags	1551	Parameters::Device Manager::Drive info				NEVER
<p>Manufacturing flags byte read from the power electronics stack.</p> <p>Bit 0 When set, indicates that the dynamic brake switch power electronics is fitted. On larger frame sizes the brake switch is a factory fit option. On frames C,D,E,F and G this bit is ignored.</p> <p>Bit 1 – 7 Reserved</p>						
Manufacturing Flags	1636	Parameters::Device Manager::Drive info				NEVER
<p>Manufacturing flags word read from the control module.</p> <p>Bit 0 When set, indicates that the drive is a special build.</p> <p>Bits 1 – 15 Reserved</p>						
OEM ID	1256	Parameters::Device Manager::Drive info				NEVER
<p>A 16-bit integer set in the factory, that identifies the equipment manufacturer. This may be used to lock or tailor an application to a given manufacturer. To obtain a unique ID apply to Parker Hannifin Electromechanical Drives Business Unit.</p>						

C-62 Parameter Reference

Encoder

**Setup::Inputs and Outputs::Option
Monitor::Inputs and Outputs
Parameters::Option IO::Encoder**

This feature allows you to setup and monitor the operation of the **Encoder**.

Parameter Name	No.	Path	Default	Range	Units	Writable
Encoder Supply	1511	Setup::Inputs and Outputs::Option Parameters::Option IO::Encoder	0	0:5 V 1:12 V 2:15 V 3:24 V		STOPPED
Allows the user to select the correct supply voltage for the pulse encoder.						
Encoder Lines	1512	Same as PNO 1511	2048	1 to 100000		STOPPED
The number of lines per one encoder revolution, as required by the encoder in use. Incorrect setting of this parameter will result in an erroneous speed measurement.						
Encoder Invert	1513	Same as PNO 1511	FALSE			STOPPED
Reverses the encoder direction if set to TRUE. The encoder direction needs to be correct if encoder feedback is used to control the motor in vector mode. The autotune identifies whether the parameter is in the correct state required to control the motor, and changes it if necessary. It is possible to do this manually, by attempting to run the motor, and changing the parameter if necessary until the motor is controlled correctly.						
Encoder Type	1514	Same as PNO 1511	0	0:QUADRATURE 1:CLOCK/DIRECTION		STOPPED
Normally the encoder type will be quadrature. Exceptionally, e.g. if a proximity sensor or other pulse train is used, it needs to be clock / direction type.						
Encoder Single Ended	1515	Same as PNO 1511	FALSE			STOPPED
If set to TRUE this parameter informs the encoder option card to expect just A and B from the encoder, not differential /A and /B.						

Parameter Name	No.	Path	Default	Range	Units	Writable
Encoder Speed	1516	Monitor::Inputs and Outputs Parameters::Option IO::Encoder	x.	Min to Max	RPM	NEVER
The speed measured by the encoder, in revolutions per minute.						
Encoder Count Reset	1517	Same as PNO 1511	FALSE			ALWAYS
If set to TRUE resets the encoder count.						
Encoder Count Init	1783	Parameters::Option IO::Encoder	TRUE			ALWAYS
If set to TRUE the encoder count is reset to zero when the drive powers up.						
Encoder Count	1518	Same as PNO 1516		Min to Max		NEVER
This parameter shows the encoder count, which is a 32 bit counter that will increment and decrement with the encoder pulses, up to 2^{31} or down to -2^{31} .						

C-64 Parameter Reference

Energy Meter

Monitor::Energy Meter

Parameters::Motor Control::Energy Meter

This feature measures the electrical energy used by the motor.

Parameter Name	No.	Path	Default	Range	Units	Writable
Power kW	0380	Monitor::Energy Meter Parameters::Motor Control::Energy Meter	x.xx	0.00 to 1000000.00	kW	NEVER
This diagnostic shows the power being delivered to the load in kilowatts.						
Power HP	0381	Same as PNO 380	x.xx	0.00 to 1000000.00	HP	NEVER
This diagnostic shows the power being delivered to the load in horsepower.						
Reactive Power	0382	Same as PNO 380	x.xx	0.00 to 1000000.00	kVAr	NEVER
This diagnostic shows the reactive power being delivered to the load in kilo volt-amperes reactive.						
Energy kWh	0383	Same as PNO 380	x.xx	0.00 to 10000000.00	kWh	NEVER
This diagnostic shows the total energy consumed by the load in kilowatt hours.						
Power Factor Est	0385	Same as PNO 380	x.xx	0.00 to 1.00		NEVER
This diagnostic shows the power factor estimate (between 0 and 1).						
Power Factor Angle Est	0386	Parameters::Motor Control::Energy Meter	x.xx	0.00 to 90.00	deg	NEVER
This diagnostic shows the power factor angle estimate.						
Reset Energy Meter	0389	Parameters::Motor Control::Energy Meter	FALSE			ALWAYS

Parameter Name	No.	Path	Default	Range	Units	Writable
<p>When Reset Energy Meter is set to TRUE, the Energy KWh parameter is reset to zero automatically when the maximum value is reached.</p> <p>When Reset Energy Meter is set to FALSE, the Energy KWh parameter is held at the maximum value when the maximum value has been reached</p> <p>Changing this from FALSE to TRUE at anytime will cause the Energy KWh parameter to be reset to zero.</p>						

C-66 Parameter Reference

EtherCAT Option

Monitor::Communications::Option

Setup::Communications::Option

Parameters::Option Comms::Comms

Parameters::Option Comms::Read Process

Parameters::Option Comms::Write Process

Parameters::Option Comms::Event

Parameters::Option Comms::EtherCAT

[Refer to EtherCAT Technical Manual HA501938U001](#)

Ethernet

Monitor::Communications::Base Ethernet

Setup::Communications::Base Ethernet

Parameters::Base Comms::Ethernet

[Refer to Chapter 8 Ethernet](#)

EtherNet IP Adapter

Setup::Communications:: Base EtherNet IP

Monitor::Communications::Base Ethernet IP

Parameters::Base Comms::Ethernet IP Adapter

[Refer to Appendix A](#)

EtherNet IP Option

Monitor::Communications::Option

Setup::Communications::Option

Parameters::Option Comms::Comms

Parameters::Option Comms::Read Process

Parameters::Option Comms::Write Process

Parameters::Option Comms::Event

Parameters::Option Comms::Option Ethernet

Parameters::Option Comms::EtherNet IP

[Refer to EtherNet IP Technical Manual HA501842U001](#)

C-68 Parameter Reference

Fan Control

Parameters::Motor Control::Fan Control

<i>Parameter Name</i>	<i>No.</i>	<i>Path</i>	<i>Default</i>	<i>Range</i>	<i>Units</i>	<i>Writable</i>
Force Fan On	0113	Parameters::Motor Control::Fan Control	FALSE			ALWAYS

Turns the main cooling fan on.

Functional Description

The purpose of this parameter is to turn the fan on when it would otherwise not be running. This may be useful to stir air in an enclosure if the drive has been idle for an extended period of time. Stiring air can help to reduce condensation in an enclosure.

The fan will always turn on independently of “Force Fan On” if the drive heatsink is hot or if the drive is running. In this case the fan will continue to run for one minute after the drive has stopped and the heatsink is cool. This mode of operation over-rides the “Force Fan On” parameter.

Feedbacks

Parameters::Motor Control::Feedbacks

The **Feedbacks** feature allows you to view speed feedback and motor current related diagnostics.

Parameter Name	No.	Path	Default	Range	Units	Writable
Duty Selection	0390	Setup::Motor Control::Control and Type Parameters::Motor Control::Feedbacks	1	0:HEAVY DUTY 1:NORMAL DUTY		STOPPED

Heavy Duty (typically 150%, 60s).

Normal Duty allowing higher continuous ratings with less overload capability (typically 110%, 60s).

% are related to the Drive/stack ratings.

For example, a 12A drive (@4kHz) under Normal Duty becomes a 10A drive (@4kHz) under Heavy Duty

DC Link Voltage	0392	Monitor::Motor and Drive Monitor::Regen Control Parameters::Motor Control::Feedbacks	x.	0 to 1000	V	NEVER
------------------------	------	--	----	-----------	---	-------

This shows the voltage across the dc link capacitors.

Actual Speed RPM	0393	Monitor::Motor and Drive Parameters::Motor Control::Feedbacks	x.xx	-100000.00 to 100000.00	RPM	NEVER
-------------------------	------	--	------	-------------------------	-----	-------

This parameter changes according to the **Control Strategy**:

- In Vector Control mode the parameter shows the calculated mechanical speed of the motor shaft in rpm.
- In Volts-Hertz Control mode the parameter shows motor synchronous speed in rpm.

C-70 Parameter Reference

Parameter Name	No.	Path	Default	Range	Units	Writable
Actual Speed rps	0394	Same as PNO 393	x.xx	-1500.00 to 1500.00	rev/s	NEVER
<p>This parameter changes according to the Control Strategy:</p> <ul style="list-style-type: none"> In Vector Control mode the parameter shows the calculated mechanical speed of the motor shaft in revolutions per second. In Volts-Hertz Control mode, the parameter shows the motor synchronous speed in revolutions per second. 						
Actual Speed Percent	0395	Same as PNO 393	x.xx	-200.00 to 200.00	%	NEVER
<p>This parameter changes according to the Control Strategy</p> <ul style="list-style-type: none"> In Vector Control mode the parameter shows the calculated mechanical speed of the motor shaft as a percentage of the user maximum speed setting (100% Speed in RPM in the Scale Setpoint function). In Volts-Hertz Control mode, the parameter shows the electrical drive output frequency as a percentage of the user maximum speed setting (100% Speed in RPM in the Scale Setpoint function). 						
Actual Position	1213	Same as PNO 393	x.x	-180.0 to 180.0	deg	NEVER
<p>This parameter is visible when the system is run in Vector Control Mode with a feedback selected. This parameter is the feedback position in degrees (the feedback is selected in the Control Mode menu)</p>						
DC Link Volt Filtered	0396	Same as PNO 393	x.	0 to 1000	V	NEVER
<p>This shows the filtered voltage across the dc link capacitors.</p>						
DC Link Volts Trim	0119	Parameters::Motor Control::Feedbacks	0	-20 to 20	V	ALWAYS
<p>Specifies a trim to add to the DC Link voltage feedback. This is useful when it is necessary for all the drives in a system to read exactly the same DC Link voltage.</p>						
id	0397	Parameters::Motor Control::Feedbacks	x.x	-600.0 to 600.0	%	NEVER
<p>Current in the flux axis (Vector Control)</p>						

Parameter Reference C-71

Parameter Name	No.	Path	Default	Range	Units	Writable
iq	0398	Parameters::Motor Control::Feedbacks	x.x	-600.0 to 600.0	%	NEVER
Current in the torque axis (Vector Control)						
Actual Torque	0399	Same as PNO 393	x.x	-600.0 to 600.0	%	NEVER
Calculated torque, based on the Iq current.						
Actual Field Current	0400	Same as PNO 393	x.x	-200.0 to 200.0	%	NEVER
Calculated field, based on the Id current.						
Motor Current Percent	0401	Same as PNO 393	x.x	0.0 to 600.0	%	NEVER
This diagnostic shows the level of rms line current being drawn from the drive as a percentage of the rated current of the relevant motor definition.						
Motor Current	0402	Same as PNO 393	x.x	0.0 to 2000.0	A	NEVER
This diagnostic shows the level of rms line current in Amps being drawn from the Drive.						
100% Stack Current A	0403	Parameters::Motor Control::Feedbacks	x.x	0.0 to 2000.0	A	NEVER
This diagnostic indicates the stack rating in Amps. This reduces as a function of pwm switching frequency.						
Stack Current (%)	0404	Parameters::Motor Control::Feedbacks	x.	0 to 500	%	NEVER
Stack current percentage.						
Motor Terminal Volts	0405	Same as PNO 393	x.	0 to 1000	V	NEVER
Volts between motor phases in Vrms.						

C-72 Parameter Reference

Parameter Name	No.	Path	Default	Range	Units	Writable
CM Temperature	0406	Same as PNO 393	x.x	-25.0 to 200.0	°C	NEVER
Temperature of Control Module in °Centigrade.						
Heatsink Temperature	0407	Same as PNO 393	x.x	-25.0 to 200.0	°C	NEVER
Power stack heatsink temperature in °Centigrade.						
Elec Rotor Speed	0408	Parameters::Motor Control::Feedbacks	x.x	-1500.0 to 1500.0	Hz	NEVER
Mechanical speed (shaft speed in ^{rev/s}) x number of motor pole pairs. This parameter is not filtered.						

Fieldbus Mapping

Parameters::Base Comms::Fieldbus Mapping

[Refer to Appendix A](#)

C-74 Parameter Reference

Filter On Torque Dmd

Parameters::Motor Control::Filter On Torque Dmd

This feature allows to select the type of filter applied to the Torque setpoint:

- Either the output of the speed loop PI corrector if the speed loop is active
- Or the torque Setpoint .

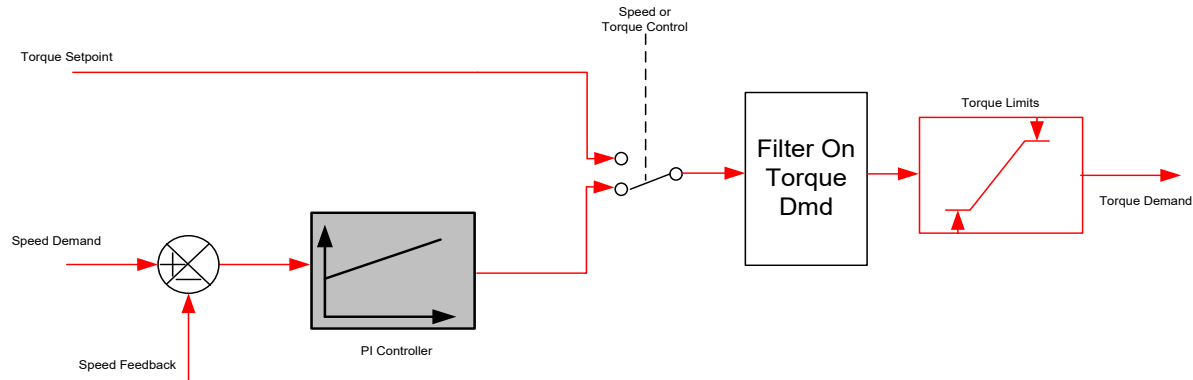

The general structure of the filter is given below :

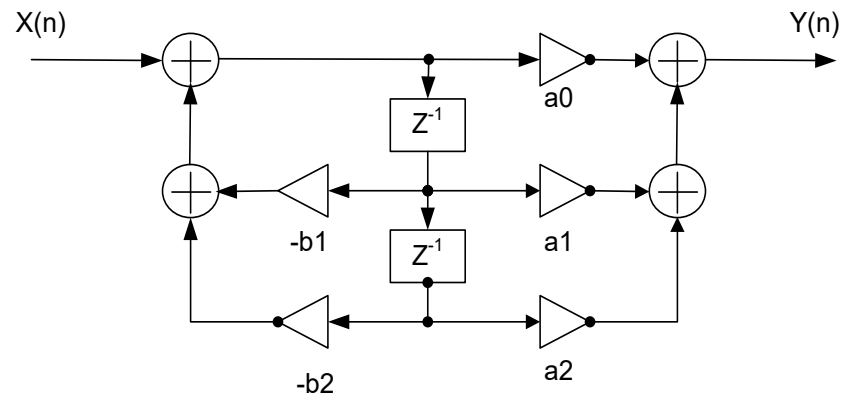

$$H(z) = \frac{a_0 + a_1 \cdot z^{-1} + a_2 \cdot z^{-2}}{1 + b_1 \cdot z^{-1} + b_2 \cdot z^{-2}} \quad \text{or} \quad y_n = a_0 \cdot x_n + a_1 \cdot x_{n-1} + a_2 \cdot x_{n-2} - b_1 \cdot y_{n-1} - b_2 \cdot y_{n-2}$$

Parameter Name	No.	Path	Default	Range	Units	Writable
Filter Type	1544	Parameters::Motor Control::Filter On Torque Dmd	0	0:NONE 1:MAX ATTENUATION 2:MINIMUM PHASE 3:PHASE ADVANCE 4:NOTCH		ALWAYS

NONE : no filter applied – no parameter selection

MAX ATTENUATION : First Order Low Pass Filter (Butterworth form). 3dB attenuation frequency given by **Cut Off Frequency**.

$$H(s) = \frac{1}{1 + \tau \cdot s} \quad H(z^{-1}) = \frac{a_0 + a_1 z^{-1}}{1 + b_1 \cdot z^{-1}}$$

MINIMUM PHASE : First Order Low Pass Filter (similar to preceding, but with less phase shift and less efficient roll off characteristics). 3dB attenuation frequency given by **Cut Off Frequency**.

$$H(s) = \frac{1}{1 + \tau \cdot s} \quad H(z^{-1}) = \frac{a_0}{1 + b_1 \cdot z^{-1}}$$

PHASE ADVANCE : Gives a phase advance between **Frequency 1** and **Frequency 2**.

$$H(s) = \frac{1 + \tau_1 \cdot s}{1 + \tau_2 \cdot s} \quad H(z^{-1}) = \frac{a_0 + a_1 z^{-1}}{1 + b_1 \cdot z^{-1}}$$

NOTCH : Zero transmission notch at a frequency given by **Cut Off Frequency**. The damping factor is given by **Factor**.

$$H(s) = 1 \cdot \frac{s^2 + \omega^2}{s^2 + 2\xi\omega s + \omega^2} = \frac{1 + \frac{s^2}{\omega^2}}{1 + 2\xi \frac{s}{\omega} + \frac{s^2}{\omega^2}} \quad H(z^{-1}) = \frac{a_0 + a_1 z^{-1} + a_2 \cdot z^{-2}}{1 + b_1 \cdot z^{-1} + b_2 \cdot z^{-2}}$$

C-76 Parameter Reference

Parameter Name	No.	Path	Default	Range	Units	Writable
Cut Off Frequency	1545	Parameters::Motor Control::Filter On Torque Dmd	2000	20 to 6000	Hz	ALWAYS
<p>3dB attenuation frequency if Filter Type is MAX ATTENUATION or MINIMUM PHASE Frequency of Zero transmission if Filter Type is NOTCH</p>						
Frequency 1	1546	Parameters::Motor Control::Filter On Torque Dmd	2000	20 to 6000	Hz	ALWAYS
<p>Frequency 1 if Filter Type is PHASE ADVANCE</p>						
Frequency 2	1547	Parameters::Motor Control::Filter On Torque Dmd	2000	20 to 6000	Hz	ALWAYS
<p>Frequency 2 if Filter Type is PHASE ADVANCE</p>						
Factor	1548	Parameters::Motor Control::Filter On Torque Dmd	0.20	0.10 to 1.00		ALWAYS
<p>Damping factor if Filter Type is NOTCH</p>						

Flash File System

Parameters::Device Manager::Flash File System

<i>Parameter Name</i>	<i>No.</i>	<i>Path</i>	<i>Default</i>	<i>Range</i>	<i>Units</i>	<i>Writable</i>
Free Space (kBytes)	1754	Parameters::Device Manager::Flash File System				NEVER

Indicates the remaining space available in the internal file system, (not on AC30V).

Functional Description

The internal file system on the AC30P / AC30D is primarily used to store the source code for applications. The total space available is 12MB.

C-78 Parameter Reference

Fluxing VHz

Parameters::Motor Control::Fluxing VHz

Designed for VOLTS/Hz motor Control Mode.

This function allows user parameterisation of the conventional (volts/hertz) fluxing strategy of the Drive. This is achieved through three flexible Volts-to-frequency templates. Starting torque performance can also be tailored through the **Fixed Boost**, **Acceleration Boost** and **Auto Boost** parameters.

Parameter Name	No.	Path	Default	Range	Units	Writable
VHz Shape	0422	Setup::Motor Control::Control and Type Parameters::Motor Control::Fluxing VHz	0	0:LINEAR LAW 1:FAN LAW 2:USER DEFINED 3:APPLICATION DEFINED		STOPPED

Type of volts to frequency template to flux the motor. The choices for this parameter are:

Enumerated Value : VHz Shape

- 0 : LINEAR LAW This gives a constant flux characteristic up to the **Base Frequency** (see **Motor Nameplate** function).
- 1 : FAN LAW This gives a quadratic flux characteristic up to the **Base Frequency**. This matches the load requirement for fan and most pump applications
- 2 : USER DEFINED This gives a user defined flux characteristic up to the **Base Frequency**.
- 3 : APPLICATION DEFINED This gives a user the ability to set up and apply fluxing law from the application layer.

V/F SHAPE

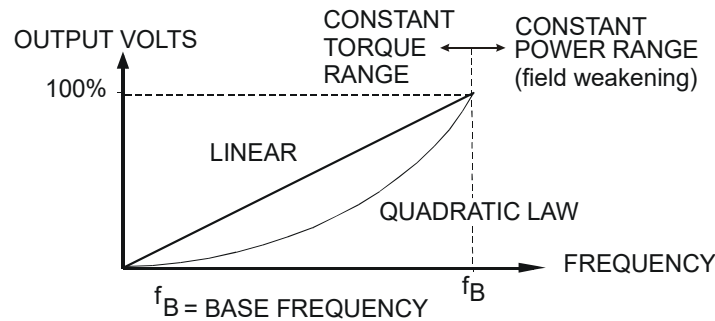

Fixed Boost	0447	Same as PNO 422	0.0	0.0 to 25.0	%	ALWAYS
--------------------	------	-----------------	-----	-------------	---	--------

Parameter Name	No.	Path	Default	Range	Units	Writable
----------------	-----	------	---------	-------	-------	----------

This parameter allows for no-load stator resistance voltage drop compensation. This correctly fluxes the motor (under no-load conditions) at low output frequencies, thereby increasing available motor torque. Fixed boost can be set in addition to auto boost and acceleration boost.

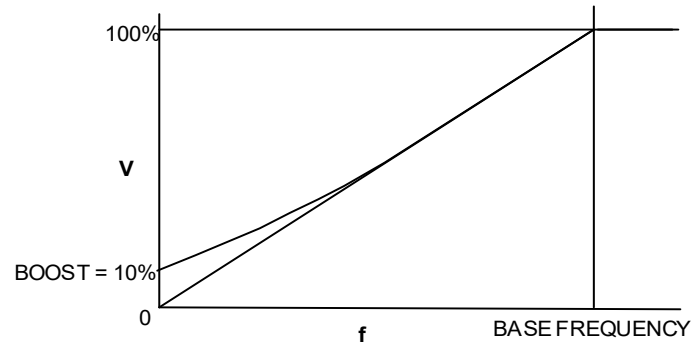

Auto Boost	0448	Parameters::Motor Control::Fluxing VHz	0.0	0.0 to 25.0	%	ALWAYS
-------------------	------	--	-----	-------------	---	--------

This parameter allows for load dependent stator resistance voltage drop compensation. This correctly fluxes the motor (under load conditions) at low output frequencies, thereby increasing available motor torque. **Auto Boost** can be set in addition to **Fixed Boost**.

The value of the **Auto Boost** parameter determines level of additional volts supplied to the motor for 100% load.

Setting the value of auto boost too high can cause the Drive to enter current limit. If this occurs, the Drive will be unable to ramp up in speed. Reducing the value of auto boost will eliminate this problem.

Acceleration Boost	0450	Parameters::Motor Control::Fluxing VHz	0.0	0.0 to 25.0	%	ALWAYS
---------------------------	------	--	-----	-------------	---	--------

Additional amount of fixed boost when the drive is accelerating.

Energy Saving Enable	0451	Parameters::Motor Control::Fluxing VHz	FALSE			ALWAYS
-----------------------------	------	--	-------	--	--	--------

Enable/Disable energy saving mode to minimize energy consumption.

C-80 Parameter Reference

Parameter Name	No.	Path	Default	Range	Units	Writable
VHz User Freq	0423	Parameters::Motor Control::Fluxing VHz			%	STOPPED
Array of user defined frequency for V/f control						
VHz User Volts	0435	Parameters::Motor Control::Fluxing VHz		0.0 to 100.0	%	STOPPED
Array of VHz User Volts for V/f control						
Application User Boost	1633	Parameters::Motor Control::Fluxing VHz	0.00	0.00 to 25.00	%	ALWAYS
User boost for V/Hz control from application						
Application Volts	1549	Parameters::Motor Control::Fluxing VHz	0.00	0.00 to 150.00	%	ALWAYS
Volts for V/Hz control, if fluxing law is done in the application						
Energy Saving Lower Lim	1526	Parameters::Motor Control::Fluxing VHz	0.00	0.00 to 1.00		ALWAYS
Energy Saving Lower Limit for application defined fluxing						
Vsd Demand	0453	Parameters::Motor Control::Fluxing VHz	x.x		%	NEVER
The amount of voltage applied in the direct or flux axis						
Vsq Demand	0454	Parameters::Motor Control::Fluxing VHz	x.x		%	NEVER
The amount of voltage applied in the quadrature or torque axis						

Functional Description

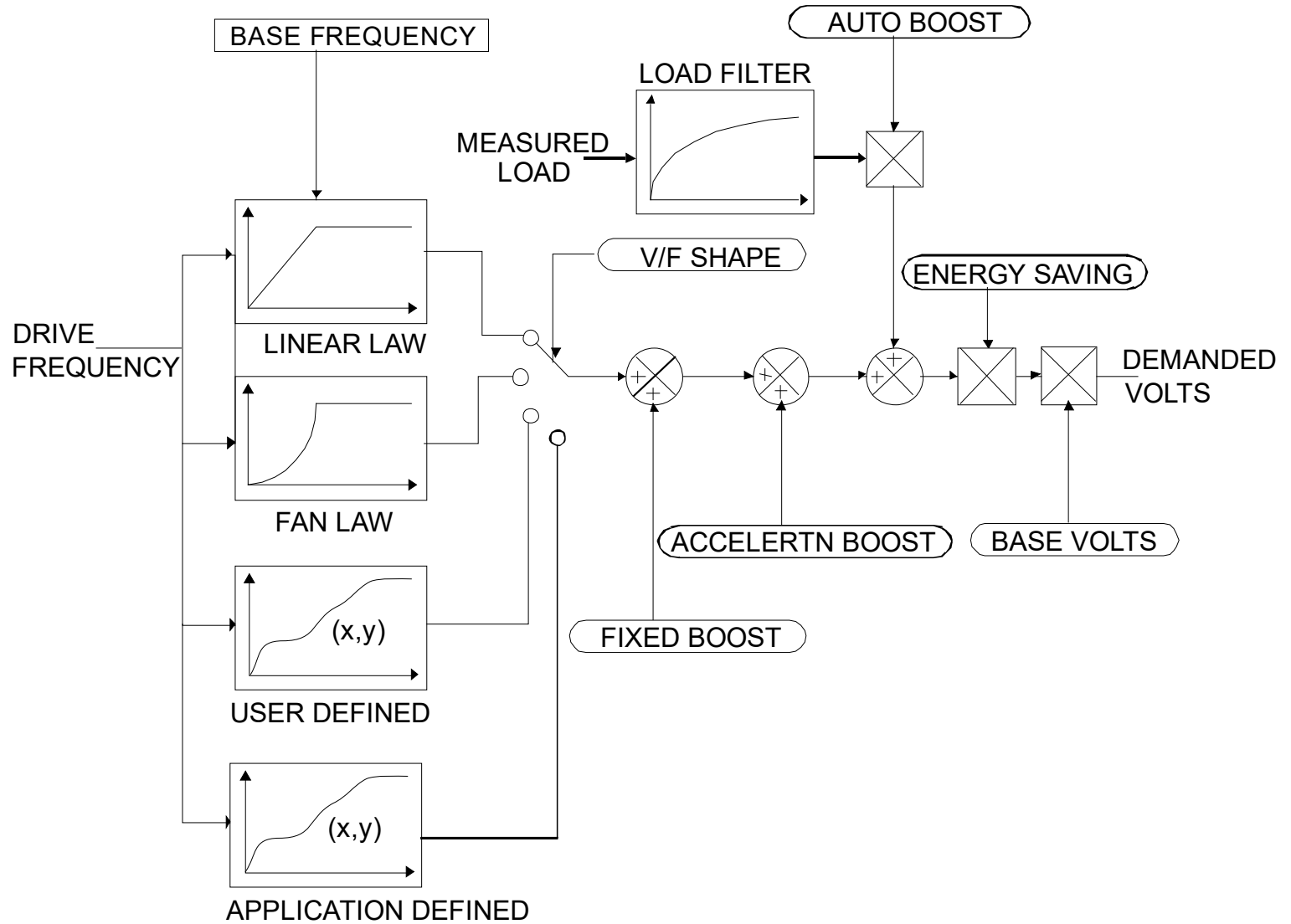

C-82 Parameter Reference

V/F Shape

The function allows the user to parameterise the Drive's conventional V/F motor fluxing scheme. Four V/F shapes are available, LINEAR LAW, FAN LAW, USER DEFINED, and APPLICATION DEFINED:

- ◆ Linear Law V/F shape should be used in applications requiring constant motor torque though out the speed range (e.g. machine tools or hoists).
- ◆ Fan Law V/F shape provides less torque capabilities for lower speeds, which means some energy savings can be achieved for fan or pump applications when they operate at lower speed/load setpoints. When choosing fan law shape the user should carefully consider if such profile is suitable for the overall load cycle of their application.
- ◆ User Defined V/F shape provides a method for the user to define any profile. 10 user definable (x,y) points are provided. Linear interpolation is used between each point. The drive also assumes the following points - (0%,0%) and (100%,100%) - though these may be overridden. For example, (USER FREQ 1 = 0%, USER VOLTAGE 1 = 5%) takes precedence over (0%, 0%).
- ◆ Application Defined V/F shape provides a method for the user to define any fluxing profile within the application layer. In the application the user can set desired voltage level for any operating frequency, and the application will dynamically provide that value to the firmware, via the "Application Volts" parameter. If this mode is used, it is recommended that such application is executed in 1ms time frame.

For any of these V/F shapes the **Base Frequency** parameter (in the **Motor Nameplate** function) which is the value of Drive output frequency at which maximum output volts is provided, can be set by the user.

Boost Parameters

- ◆ Correct no-load motor fluxing at low Drive output frequencies can be achieved by setting the **Fixed Boost** parameter.
- ◆ Correct motor fluxing under load conditions is achieved by setting the **Auto Boost** parameter. The motor is correctly fluxed when the **Actual Field Current** diagnostic in the **Feedbacks** function reads 100.0% .
- ◆ Additional **Fixed Boost** can be applied during acceleration by setting the **Acceleration Boost** parameter. This can be useful for starting heavy/high stiction loads.

Saving Energy

An **Energy Saving** mode is provided to allow the user to choose to optimize energy consumption under low load conditions in steady state. As soon as the load is increased or acceleration is required, the drive suspends energy saving mode, and returns to it only if the load conditions are such that it is allowed to do so. If enabled, energy saving mode is reducing the voltage of the motor to a level required to maintain specific setpoint speed at a particular low load. For sustained low load conditions it is not necessary to keep the motor fluxed for rated torque capabilities, so the motor voltage is reduced to a level that will still provide required torque, but not much more torque. This operation on the cusp of required torque is also the biggest weakness of energy saving mode. Energy saving procedure does monitor torque demand and as soon as it detects its rise the drive switches from energy saving mode to normal mode of operation. However, sudden increases in load may be too quick to be dealt with by energy saving mode, and may lead to stall or trip conditions. This will occur if the time to correctly re-flux the motor takes longer than the time of load increase, when there can be a window of time when the motor is simply not able to generate sufficient torque necessary for the new, increased load conditions. For this reason the user has to be very careful when choosing to utilize energy saving mode.

Energy saving mode should ideally be used in applications where there are prolonged periods of low load operation, with no fast excursions towards rated torque. The user always has to be certain that the overall load cycle for their application would still be correctly serviced if the energy saving mode is enabled, and that energy saving mode is not being incorrectly used at the expense of required performance.

Flycatching

Parameters::Motor Control::Flycatching

Only available if IM MOTOR selected in **Control Mode**

This feature performs a directional speed search. It allows the Drive to seamlessly catch a spinning motor before controlling the motor to the desired setpoint. This is especially useful for large inertia fan loads, where drafts in building air ducts can cause a fan to 'windmill'.

Parameter Name	No.	Path	Default	Range	Units	Writable
VHz Flying Start Enable	0310	Parameters::Motor Control::Flycatching	FALSE			ALWAYS
Enable flycatching in V/Hz control mode when TRUE						
VC Flying Start Enable	0311	Parameters::Motor Control::Flycatching	FALSE			ALWAYS
Enable flycatching in Vector control mode when TRUE						
Flying Start Mode	0312	Parameters::Motor Control::Flycatching	0	0:ALWAYS 1:TRIP OR POWER UP 2:TRIP		ALWAYS
Mode of operation - V/Hz control						
Search Mode	0313	Parameters::Motor Control::Flycatching	0	0:BIDIRECTIONAL 1:UNIDIRECTION		ALWAYS
The type of speed search carried out by the flycatching sequence.						
Search Volts	0314	Parameters::Motor Control::Flycatching	9.0	0.0 to 100.0	%	ALWAYS
Only under VHz control The percentage level of the search volts applied to the motor during the speed search phase of the flycatching sequence. Increasing this parameter improves the accuracy of the discovered motor speed but increases the braking influence of the speed search on the rotating motor.						
Search Boost	0315	Parameters::Motor Control::Flycatching	40.0	0.0 to 50.0	%	ALWAYS
Only under VHz control						

C-84 Parameter Reference

Parameter Name	No.	Path	Default	Range	Units	Writable
The level of search boost applied to the motor during the speed search phase of the flycatching sequence.						
Search Time	0316	Parameters::Motor Control::Flycatching	5.000	0.100 to 60.000	s	ALWAYS
<p>Only under VHz Control</p> <p>The search rate during the speed search phase of the flycatching sequence. Performing the flycatching speed search too quickly can cause the drive to inaccurately identify the motor speed. Refluxing at an inaccurate motor speed can cause the drive to trip on overvoltage. If this occurs, increasing this parameter will reduce the risk of tripping.</p>						
Min Search Speed	0317	Parameters::Motor Control::Flycatching	5	0 to 500	Hz	ALWAYS
<p>Only under VHz Control</p> <p>The lowest search speed before the speed search phase of the flycatching sequence is considered to have failed.</p>						
Flying Reflux Time	0318	Parameters::Motor Control::Flycatching	3.000	0.100 to 10.000	s	ALWAYS
<p>Only under VHz Control</p> <p>The rate of rise of volts from the search level to the working level after a successful speed search. Refluxing the motor too quickly can cause the Drive to trip on either overvoltage or overcurrent. In either case, increasing this parameter will reduce the risk of tripping.</p>						

Functional Description

The flycatching function enables the drive to be restarted smoothly into a spinning motor. It applies small search voltages to the motor whilst ramping the Drive frequency from maximum speed to zero. When the motor load goes from motoring to regenerating, the speed search has succeeded and is terminated. If the search frequency falls below the minimum search speed, the speed search has failed and the Drive will ramp to the speed setpoint from zero.

The flycatching sequence can be triggered by different starting conditions:

ALWAYS:	All starts (after controlled or uncontrolled stop, or after a power-up)
TRIP or POWER-UP:	After uncontrolled stop, i.e. trip or coast, or after a power-up
TRIP:	After uncontrolled stop, i.e. trip or coast

The type of speed sequence may be Bi-directional or Unidirectional:

Bi-directional

Initially, the search is performed in the direction of the speed setpoint. If the drive fails to identify the motor speed in this direction, a second speed search is performed in the reverse direction.

Unidirectional

The search is performed only in the direction of the speed setpoint.

General Purpose IO

Monitor::Inputs and Outputs

Parameters::Option IO::General Purpose IO

The General Purpose IO parameters configure the use of the four IO Options. This group of parameters is only visible when an IO Option is selected.

Parameter Name	No.	Path	Default	Range	Units	Writable
Anin 11 Value	1181	Monitor::Inputs and Outputs Parameters::Option IO::General Purpose IO	x.xx	-100.00 to 100.00	%	NEVER
(Terminal X21.2) - The input value expressed as a percentage of range, (+/- 100%), following Offset and Scale.						
Anin 12 Value	1182	Same as PNO 1181	x.xx	-100.00 to 100.00	%	NEVER
(Terminal X21.3) - The input value expressed as a percentage of range, (+/- 100%), following Offset and Scale.						
Anin 13 Value	1183	Same as PNO 1181	x.xx	-100.00 to 100.00	%	NEVER
(Terminal X21.4) - The input value expressed as a percentage of range, (+/- 100%), following Offset and Scale.						
Anin 11 Offset	1461	Setup::Inputs and Outputs::Option Parameters::Option IO::General Purpose IO	0.00	Min to Max	%	ALWAYS
The offset is expressed as a percentage of the hardware range. For example an offset of 10% is equivalent to 1V on the input. The offset is added to the measured value.						
Anin 11 Scale	1462	Same as PNO 1461	1.0000	Min to Max		ALWAYS
The scale is a simple multiplication factor. The input voltage is converted to a percentage value. 1461 Anin 11 Offset is added and the result is multiplied by Scale. The result is presented in parameter 1181 Anin 11 Value .						
Anin 12 Offset	1463	Same as PNO 1461	0.00	Min to Max	%	ALWAYS
The offset is expressed as a percentage of the hardware range. For example an offset of 10% is equivalent to 1V on the input. The offset is added to the measured value.						
Anin 12 Scale	1464	Same as PNO 1461	1.0000	Min to Max		ALWAYS

C-86 Parameter Reference

Parameter Name	No.	Path	Default	Range	Units	Writable
----------------	-----	------	---------	-------	-------	----------

The scale is a simple multiplication factor. The input voltage is converted to a percentage value. **1463 Anin 12 Offset** is added and the result is multiplied by Scale. The result is presented in parameter **1182 Anin 12 Value**.

Anin 13 Offset	1465	Same as PNO 1461	0.00	Min to Max	%	ALWAYS
-----------------------	------	------------------	------	------------	---	--------

The offset is expressed as a percentage of the hardware range. For example an offset of 10% is equivalent to 1V on the input. The offset is added to the measured value.

Anin 13 Scale	1466	Same as PNO 1461	1.0000	Min to Max		ALWAYS
----------------------	------	------------------	--------	------------	--	--------

The scale is a simple multiplication factor. The input voltage is converted to a percentage value. **1465 Anin 13 Offset** is added and the result is multiplied by Scale. The result is presented in parameter **1183 Anin 13 Value**.

RTC Trim	1187	Parameters::Option IO::General Purpose IO	0	-40 to 40		ALWAYS
-----------------	------	---	---	-----------	--	--------

A trim value that may be used to speed up or slow down the Real Time Clock on the IO option. A positive trim value will cause the RTC to run faster, an negative value causes the RTC to run slower. Refer to the AC30V General Purpose I/O Option manual for more details.

Once programmed, the RTC trim affects the operation of the RTC both in battery backed up mode and normal running mode.

Analog input Scale and Offset

The input signal is converted to a percentage of the hardware range, that is -10V...10V is represented as -100 to 100%. The Offset is then added to this input and the result of this is multiplied by the Scale factor. The result is presented in the Value parameter.

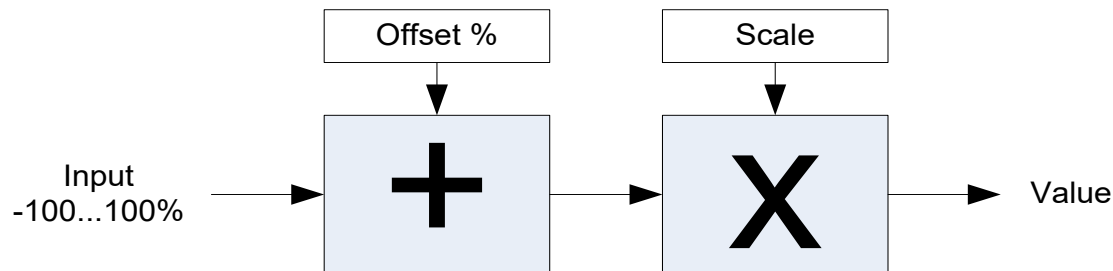

Graphical Keypad

Setup::Environment

Parameters::Keypad::Graphical Keypad

Parameter Name	No.	Path	Default	Range	Units	Writable
View Level	1141	Parameters::Keypad::Graphical Keypad	1	Same as PNO 945		ALWAYS

The view level may be used as a convenient method to hide menus and parameters not currently required. The view levels are:

0. Operator – only the “Control Screen”, “Favourites”, “Setup” and “Monitor” menus are visible.
1. Technician – additional menus are visible in the “Setup” and “Monitor” menus
2. Engineer – the “Parameters” menu is visible in addition to the above.

Startup Page	0982	Setup::Environment Parameters::Keypad::Graphical Keypad	80000000			ALWAYS
---------------------	------	--	----------	--	--	--------

On power-up the GKP briefly displays the drive name, rating and software version. After a short timeout the display automatically changes to the menu defined here. To set Startup Page, navigate to the position in the menu structure that is required, then press and hold the centre blue OK key for about 4 seconds, until the message “Startup Page” is shown.

The following special cases are defined for compatibility with previous versions of firmware.

```
80000000 Default
80000001 Control Screen
80000002 Favourites
80000003 Monitor
```

When Startup Page is set to “Default” the first menu will be:

- The “Control Screen” menu if the drive is in local sequencing mode, otherwise
- The “Favourites” menu if the Favourites menu is not empty, otherwise
- The “Monitor” menu.

Display Timeout	0983	Same as PNO 982	0.000	0.000 to 86400.000	s	ALWAYS
------------------------	------	-----------------	-------	--------------------	---	--------

When the GKP is idle, (no keys pressed), for a period longer than the Display Timeout, the display will automatically revert to the menu defined in the Startup Page parameter.

Setting the Display Timeout to zero defeats this feature.

GKP Password	1142	Setup::Environment Parameters::Keypad::Graphical Keypad	0000			ALWAYS
---------------------	------	--	------	--	--	--------

C-88 Parameter Reference

Parameter Name	No.	Path	Default	Range	Units	Writable
Password in Favourite	1097	Parameters::Keypad::Graphical Keypad	FALSE			ALWAYS
<p>Defines the password to be entered to allow modification to parameters using the GKP. This password does not affect access via the web page. A value of 0000, (the default value), inhibits the password feature. Entering a value other than 0000 causes the GKP to prompt for the password before proceeding to the parameter edit mode.</p> <p>Once a password has been entered the GKP remains unlocked. To re-lock the password return to the top of the menu tree then press Soft Key 1.</p> <p>When the GKP Password is active this parameter may be used to selectively defeat the password feature in the Favourites menu. By default this parameter is FALSE, meaning that the password is ignored when modifying Favourites parameters.</p>						
Password in Local	1098	Parameters::Keypad::Graphical Keypad	FALSE			ALWAYS
<p>When the GKP Password is active this parameter may be used to selectively defeat the password feature in the Control Screen menu. By default this parameter is FALSE, meaning that the password is ignored when modifying the Local Setpoint and other related parameters.</p>						
Technician Password	1099	Parameters::Keypad::Graphical Keypad	0000			ALWAYS
<p>The password required to change from Operator View level to Technician View Level. If this is zero then no password is required.</p>						
Engineer Password	1637	Parameters::Keypad::Graphical Keypad	0000			ALWAYS
<p>The password required to change from Operator or Technician View level to Engineer View Level. If this is zero then no password is required.</p>						
Version	1143	Parameters::Keypad::Graphical Keypad				NEVER
<p>Indicates the firmware version of the attached GKP.</p>						

Parameter Name	No.	Path	Default	Range	Units	Writable
Soft Key 2 Mode	1794	Parameters::Keypad::Graphical Keypad	0	0:LOCAL / REMOTE 1:FORWARD / REVERSE 2:CUSTOM		ALWAYS

Configures the use of Soft Key 2 when the GKP is being used to navigate through menus or parameters. When the GKP is being used to edit a parameter, or is showing the Welcome page the use of Soft Key 2 is pre-defined, as detailed in section 7.

- **LOCAL / REMOTE:** The key may be used to change the sequencing mode of the drive. When 1253 Local/Rem Key Active is FALSE this feature is disabled.
- **FORWARD / REVERSE:** The key may be used to change the direction of rotation of the drive. The icon shown above the icon indicates the direction that will be selected on pressing the key. This setting only applies in Local sequencing mode and when 1255 Local Dir Key Active is TRUE.
- **CUSTOM:** The key may be used to toggle 1795 Soft Key 2 Value. The icon shown above the soft key indicates the present state of this parameter.

Soft Key 2 Value	1795	Parameters::Keypad::Graphical Keypad	FALSE			ALWAYS
-------------------------	------	--------------------------------------	-------	--	--	--------

A parameter that is driven by Soft Key 2 when 1794 Soft Key 2 Mode is set to CUSTOM. This may be used within the configuration to allow keypad driven functionality.

C-90 Parameter Reference

Induction Motor Data

Setup::Motor Control::Induction Motor Data

Parameters::Motor Control::Induction Motor Data

Only available if IM MOTOR selected in **Control Mode**

Parameter Name	No.	Path	Default	Range	Units	Writable
Magnetising Current	0568	Parameters::Motor Control::Induction Motor Data	1.00	0.00 to 10000.00	A	ALWAYS
The no load current of the induction motor, defined as rotor flux / magnetising inductance, usually given the title "imr".						
Rotor Time Constant	0569	Parameters::Motor Control::Induction Motor Data	0.100	0.005 to 100.000	s	ALWAYS
Induction Motor rotor time constant.						
Leakage Inductance	0570	Parameters::Motor Control::Induction Motor Data	1.000	0.000 to 1000.000	mH	ALWAYS
Induction motor leakage inductance. Displayed as star or delta equivalent value according to "Per Phase Parameters" setting.						
Stator Resistance	0571	Parameters::Motor Control::Induction Motor Data	0.0000	0.0000 to 100.0000	Ohm	ALWAYS
Induction motor stator resistance. Displayed as star or delta equivalent value according to "Per Phase Parameters" setting.						
Stator Resistance	0571	Parameters::Motor Control::Induction Motor Data	0.0000	0.0000 to 100.0000	Ohm	ALWAYS
Induction motor rotor resistance. Displayed as an interim "by-product" of stationary autotune procedure. Not used in control functions.						
Mutual Inductance	0572	Parameters::Motor Control::Induction Motor Data	100.00	0.00 to 10000.00	mH	ALWAYS
Induction motor mutual inductance. Displayed as star or delta equivalent value according to "Per Phase Parameters" setting.						

Parameter Reference C-91

Parameter Name	No.	Path	Default	Range	Units	Writable
Stator Resistance	0571	Parameters::Motor Control::Induction Motor Data	0.0000	0.0000 to 100.0000	Ohm	ALWAYS

Induction motor wiring direction of the motor phases.

C-92 Parameter Reference

Inj Braking

Parameters::Motor Control::Inj Braking

Designed for VOLTS/Hz Motor Control Mode.

The injection braking feature provides a method of stopping spinning induction motors without returning the kinetic energy of the motor and load back in to the dc link of the Drive. This is achieved by running the motor highly inefficiently so that all the energy stored in the load is dissipated in the motor. Thus, high inertia loads can be stopped without the need for an external dynamic braking resistor.

Parameter Name	No.	Path	Default	Range	Units	Writable
DC Inj Deflux Time	0324	Parameters::Motor Control::Inj Braking	0.500	0.100 to 20.000	s	ALWAYS
Motor defluxed duration before starting injection braking						
DC Inj Frequency	0325	Parameters::Motor Control::Inj Braking	9	1 to 500	Hz	ALWAYS
Max frequency applied to the motor						
DC Inj Current Limit	0326	Parameters::Motor Control::Inj Braking	100.0	50.0 to 150.0	%	ALWAYS
Motor current value						
DC Pulse Time	0327	Parameters::Motor Control::Inj Braking	2.000	0.000 to 100.000	s	ALWAYS
Duration of dc pulse for motor speed below 20% of base speed						
Final DC Pulse Time	0328	Parameters::Motor Control::Inj Braking	1.000	0.000 to 10.000	s	ALWAYS
Duration of the final dc holding pulse						
DC Current Level	0329	Parameters::Motor Control::Inj Braking	3.0	0.0 to 25.0	%	ALWAYS
Level of dc pulse applied						

Parameter Reference C-93

Parameter Name	No.	Path	Default	Range	Units	Writable
DC Inj Timeout	0330	Parameters::Motor Control::Inj Braking	90.000	0.000 to 600.000	s	ALWAYS
Maximum time in the low frequency injection braking state						
DC Inj Base Volts	0331	Parameters::Motor Control::Inj Braking	100.00	0.00 to 115.47	%	ALWAYS
Maximum volts applied at base speed						

Note: DC injection braking procedure has higher percentage of successful stoppages for the lower power range (frames D-G), than at higher power range (frames H-K).

C-94 Parameter Reference

IO Configure

Setup::Inputs and Outputs

Parameters::Inputs And Outputs::IO Configure

These parameters are used to configure the input signal processing.

Parameter Name	No.	Path	Default	Range	Units	Writable
Anin 01 Type	0001	Setup::Inputs and Outputs::Base IO Parameters::Inputs And Outputs::IO Configure	0	0:-10..10 V 1:0..10 V 2:0..20 mA 3:4..20 mA		ALWAYS

Analog input 1 is associated with terminal X11.1

The signal processing electronics for analog input 1 supports four input ranges.

Anin 01 Offset	0957	Setup::Inputs and Outputs::Base IO Parameters::Inputs And Outputs::IO Configure	0.00	Min to Max	%	ALWAYS
-----------------------	------	---	------	------------	---	--------

The offset is expressed as a percentage of the hardware range selected by **0001 Anin 01 Type**. For example, with the 4..20mA range an offset of 10% is equivalent to 1.6mA on the input.

The offset is added to the measured value.

Anin 01 Scale	0958	Same as PNO 957	1.0000	Min to Max		ALWAYS
----------------------	------	-----------------	--------	------------	--	--------

The scale is a simple multiplication factor. The input voltage or current is converted to a percentage value. **0957 Anin 01 Offset** is added and the result is multiplied by **0958 Anin 01 Scale**. The result is presented in parameter **0039 Anin 01 Value**.

Anin 02 Type	0002	Same as PNO 1	0	0:-10..10 V 1:0..10 V		ALWAYS
---------------------	------	---------------	---	--------------------------	--	--------

Analog input 2 is associated with terminal X11.2

The signal processing electronics for analog input 2 supports two input ranges.

Parameter Name	No.	Path	Default	Range	Units	Writable
Anin 02 Offset	0959	Same as PNO 957	0.00	Min to Max	%	ALWAYS
<p>The offset is expressed as a percentage of the hardware range selected by 0002 Anin 02 Type. For example, with the -10..10V range an offset of 10% is equivalent to 1v on the input.</p> <p>The offset is added to the measured value.</p>						
Anin 02 Scale	0960	Same as PNO 957	1.0000	Min to Max		ALWAYS
<p>The scale is a simple multiplication factor. The input voltage is converted to a percentage value. 0959 Anin 02 Offset is added and the result is multiplied by 0960 Anin 02 Scale. The result is presented in parameter 0041 Anin 02 Value.</p>						
Anout 01 Type	0003	Same as PNO 1	0	0:-10..10 V 1:0..10 V 4:TORQUE OUT -10..10 V		ALWAYS
<p>Analog output 1 is associated with terminal X11.3 The signal processing electronics for analog output 1 supports two output ranges: 0. -10..10V 1. 0..10V 4. TORQUE OUT : output of the speed loop (torque setpoint) directly feeding the analog output 1. No delay.</p>						
Anout 01 Scale	0686	Setup::Inputs and Outputs::Base IO Parameters::Inputs And Outputs::IO Configure	1.0000	Min to Max		ALWAYS
<p>The scale is a simple multiplication factor applied to 0042 Anout 01 Value.</p>						
Anout 01 Offset	1108	Setup::Inputs and Outputs::Base IO Parameters::Inputs And Outputs::IO Configure	0.00	Min to Max	%	ALWAYS
<p>The offset is expressed as a percentage of the hardware range selected by 0003 Anout 01 Type. For example, with the -10..10V range an offset of 10% is equivalent to 1v on the output.</p> <p>The demand value 0042 Anout 01 Value is multiplied by 0686 Anout 01 Scale then added to the Offset. The resultant value is then limited to -100 to 100%, (for the -10..10V type) or 0..100%, (for the 0..10V range).</p>						

C-96 Parameter Reference

Parameter Name	No.	Path	Default	Range	Units	Writable
Anout 01 ABS	1441	Setup::Inputs and Outputs::Base IO Parameters::Inputs And Outputs::IO Configure	FALSE			ALWAYS
<p>When ABS is set TRUE, the absolute value of the result of combining 0042 Anout 01 Value, 0686 Anout 01 Scale and 1108 Anout 01 Offset is used to drive the output electronics.</p>						
Anout 02 Type	0004	Same as PNO 1	1	1:0..10 V 2:0..20 mA 3:4..20 mA		ALWAYS
<p>Analog output 1 is associated with terminal X11.4 The signal processing electronics for analog output 2 supports the three output ranges</p>						
Anout 02 Scale	1460	Same as PNO 1441	1.0000	Min to Max		ALWAYS
<p>The scale is a simple multiplication factor applied to 0043 Anout 02 Value.</p>						
Anout 02 Offset	1467	Same as PNO 1441	0.00	Min to Max	%	ALWAYS
<p>The offset is expressed as a percentage of the hardware range selected by 0004 Anout 02 Type. For example, with the 4..20mA range an offset of 10% is equivalent to 1.6mA on the output. The demand value 0043 Anout 02 Value is multiplied by 1460 Anout 02 Scale then added to the Offset. The resultant value is then limited to 0..100%.</p>						
Anout 02 ABS	1468	Same as PNO 1441	FALSE			ALWAYS
<p>When ABS is set TRUE, the absolute value of the result of combining 0043 Anout 02 Value, 1460 Anout 02 Scale and 1467 Anout 02 Offset is used to drive the output electronics.</p>						
Digin Invert	1294	Setup::Inputs and Outputs::Base IO Parameters::Inputs And Outputs::IO Configure	0000			ALWAYS
<p>Inverts all the digital inputs to the drive as a 16-bit word. The bits within the word may be accessed individually, or the entire word may be accessed as a group.</p>						

Parameter Name	No.	Path	Default	Range	Units	Writable
	Bit	Signal name	Terminal	Comment	PNO for individual bit access	
	0	Inv Digin 01	X13.2		1295	
	1	Inv Digin 02	X13.3		1296	
	2	Inv Digin 03	X13.4		1297	
	3	Inv Digin 04	X12.1	Common terminal with digital output 1	1298	
	4	Inv Digin 05	X12.2	Common terminal with digital output 2	1299	
	5	Inv Digin 06	X12.3	Common terminal with digital output 3	1300	
	6	Inv Digin 07	X12.4	Common terminal with digital output 4	1301	
	7	Inv STO Inactive	X10		1302	
	8	Inv Digin 11	X20.1	GPIO option	1303	
	9	Inv Digin 12	X20.2	GPIO option	1304	
	10	Inv Digin 13	X20.3	GPIO option	1305	
	11	Inv Digin 14	X20.4	GPIO option	1306	
	12	Inv Run Key	-	GKP Run key pressed*	1307	
	13	Inv Not Stop Key	-	GKP Stop key not pressed*	1308	
	14	Inv Stop Key	-	GKP Stop key pressed*	1309	

Digout Invert	1335	Setup::Inputs and Outputs::Base IO Parameters::Inputs And Outputs::IO Configure	0000	ALWAYS
----------------------	------	---	------	--------

Inverts the digital outputs from the drive as a 16-bit word. The bits within the word may be accessed individually, or the entire word may be accessed as a group.

Bit	Signal Name	Terminal	Comment	PNO for individual bit access
0	Inv Digout 01	X12.1	Common terminal with digital input 4	1336
1	Inv Digout 02	X12.2	Common terminal with digital input 5	1337
2	Inv Digout 03	X12.3	Common terminal with digital input 6	1338
3	Inv Digout 04	X12.4	Common terminal with digital input 7	1339
4	Inv Relay 01	X14.1&2		1340
5	Inv Relay 02	X14.3&4		1341
8	Inv Digout 11	X20.1	GPIO option	1344
9	Inv Digout 12	X20.2	GPIO option	1345
10	Inv Digout 13	X20.3	GPIO option	1346
11	Inv Digout 14	X20.4	GPIO option	1347
14	Inv Relay 11	X23.1 & 2	GPIO option	1350
15	Inv Relay 12	X23.3 & 4	GPIO option	1351

C-98 Parameter Reference

Functional Description

The values associated with each terminal are shown in the **IO Values** parameter (D-61).

Analog input

The input signal is converted to a percentage of the selected hardware range. For the -10V...10V range the input is represented as -100 to 100%, for all other ranges the input is represented as 0 to 100%. The Offset value is then added to this input and the result of this is multiplied by the scale factor. The result is presented in the Value parameter.

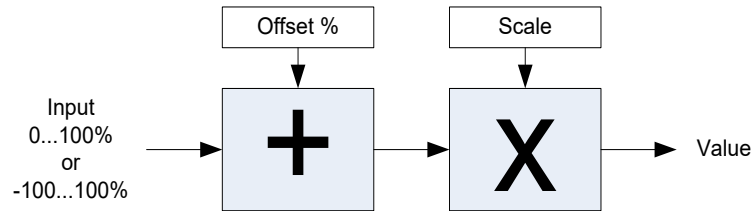

Analog output

The output demand value is multiplied by Scale before being added to the Offset. If ABS is TRUE the absolute value of this result is used. The output demand value is expressed as a percentage of the selected range.

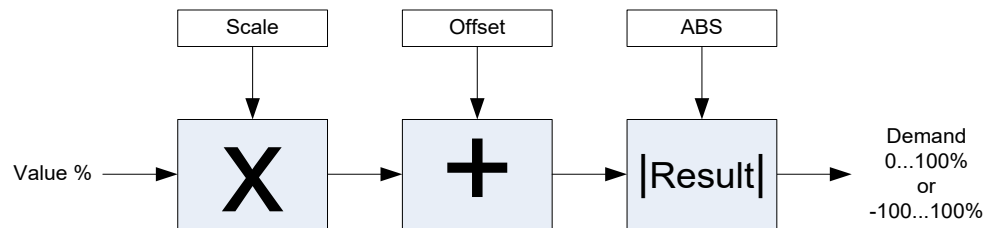

IO Option Common

Parameters::Option IO:: Option IO

Parameter Name	No.	Path	Default	Range	Units	Writable
Option IO Required	1178	Setup::Inputs and Outputs::Option Parameters::Option IO::Option IO	0	0:NONE 1:GENERAL PURPOSE 2:THERMISTOR 3:RTC AND THERMISTOR 4:PULSE ENCODER 5:RESOLVER AND THERMIST		STOPPED
Defines the type of IO option required by the configuration.						
Option IO Fitted	1179	Parameters::Option IO::Option IO		Same as PNO 1178		NEVER
Indicates the type of IO option that is currently fitted						
Option IO Diagnostic	1180	Parameters::Option IO::Option IO		0:OK 1:OPTION NOT FITTED 2:TYPE MISMATCH 3:TYPE UNKNOWN 4:HARDWARE FAULT		NEVER
Indicates the status of the IO option						

C-100 Parameter Reference

Functional Description

These parameters are used to set and verify the **IO Option** configuration. If the status parameter is not OK then the drive will not enter the Operational state.

Status	Description
OK	The configuration is valid. The status will always be OK if no IO option is required, even if one is fitted. Alternatively, if the IO option fitted is working correctly and supports the required functionality then the status will be OK For example, if the required type is THERMISTOR and the actual type is GENERAL PURPOSE then the status will be OK as the General Purpose option supports the thermistor functionality.
OPTION NOT FITTED	An option was required and none was detected
TYPE MISMATCH	The fitted option does not support the required features
TYPE UNKNOWN	The firmware in the drive does not recognise the fitted option
HARDWARE FAULT	The fitted option is not working as expected.

IO Values

Monitor::Inputs and Outputs

Parameters::Inputs and Outputs::IO Values

These parameters present the Input and Output values in a form suitable for processing by the application and fieldbus.

Parameter Name	No.	Path	Default	Range	Units	Writable
Digout Value	0022	Monitor::Inputs and Outputs Parameters::Inputs And Outputs::IO Values	0000	0:Digout 01 1:Digout 02 2:Digout 03 3:Digout 04 4:Relay 01 5:Relay 02 8:Digout 11 9:Digout 12 10:Digout 13 11:Digout 14 14:Relay 11 15:Relay 12		ALWAYS

Presents all the digital outputs from the drive as a 16-bit word. The bits within the word may be accessed individually, or the entire word may be accessed as a group.

Bit	Signal Name	Terminal	Comment	PNO for individual bit access
0	Digital Output 01	X12.1	Common terminal with digital input 4	0023
1	Digital Output 02	X12.2	Common terminal with digital input 5	0024
2	Digital Output 03	X12.3	Common terminal with digital input 6	0025
3	Digital Output 04	X12.4	Common terminal with digital input 7	0026
4	Relay 01	X14.1&2		0027
5	Relay 02	X14.3&4		0028
8	Digital Output 11	X20.1	GPIO option	0031
9	Digital Output 12	X20.2	GPIO option	0032
10	Digital Output 13	X20.3	GPIO option	0033
11	Digital Output 14	X20.4	GPIO option	0034
14	Relay 11	X23.1 & 2	GPIO option	0037
15	Relay 12	X23.3 & 4	GPIO option	0038

C-102 Parameter Reference

Parameter Name	No.	Path	Default	Range	Units	Writable
Digin Value	0005	Monitor::Inputs and Outputs Parameters::Inputs And Outputs::IO Values		0:Digin 01 1:Digin 02 2:Digin 03 3:Digin 04 4:Digin 05 5:Digin 06 6:Digin 07 7:STO Inactive 8:Digin 11 9:Digin 12 10:Digin 13 11:Digin 14 12:Run Key 13:Not Stop Key 14:Stop Key		NEVER

Presents all the digital inputs to the drive as a 16-bit word. The bits within the word may be accessed individually, or the entire word may be accessed as a group.

Bit	Signal name	Terminal	Comment	PNO for individual bit access
0	Digital Input 01	X13.2		0006
1	Digital Input 02	X13.3		0007
2	Digital Input 03	X13.4		0008
3	Digital Input 04	X12.1	Common terminal with digital output 1	0009
4	Digital Input 05	X12.2	Common terminal with digital output 2	0010
5	Digital Input 06	X12.3	Common terminal with digital output 3	0011
6	Digital Input 07	X12.4	Common terminal with digital output 4	0012
7	STO Inactive	X10		0013
8	Digital Input 11	X20.1	GPIO option	0014
9	Digital Input 12	X20.2	GPIO option	0015
10	Digital Input 13	X20.3	GPIO option	0016
11	Digital Input 14	X20.4	GPIO option	0017
12	Run Key	-	GKP Run key pressed*	0018
13	Not Stop Key	-	GKP Stop key not pressed*	0019
14	Stop Key	-	GKP Stop key pressed*	0020

* If the GKP is not fitted then both "Not Stop Key" and "Stop Key" will be 0. This condition may be used to detect a disconnected GKP.

Parameter Reference C-103

Parameter Name	No.	Path	Default	Range	Units	Writable								
Anin 01 Value	0039	Same as PNO 38	x.x	-100.0 to 100.0	%	NEVER								
Terminal X11.1 The value returned by the signal processing electronics. For unipolar ranges, (all except -10..10V), the value is expressed as a percentage of the hardware range. For the -10..10V range the full range signal is expressed as -100% to +100%.														
Anin 01 Break	0040	Same as PNO 38				NEVER								
When the input range is set to 4..20mA a break is defined as an input signal less than 3mA. Otherwise this parameter is set to FALSE.														
Anin 02 Value	0041	Same as PNO 38	x.x	-100.0 to 100.0	%	NEVER								
Terminal X11.2 The value returned by the signal processing electronics. For the 0..10V range the value is expressed as a percentage of the hardware range, (0 to 100%). For the -10..10V range the full range signal is expressed as -100% to +100%.														
Anout 01 Value	0042	Same as PNO 38	0.00	Min to Max	%	ALWAYS								
Terminal X11.3 The desired output value expressed as a percentage of the output range. <table border="1" data-bbox="537 957 1120 1101"> <thead> <tr> <th>Range</th> <th>Mapping</th> </tr> </thead> <tbody> <tr> <td>0..10V</td> <td>0% gives 0V, 100% gives 10V</td> </tr> <tr> <td>0..20mA</td> <td>0% gives 0mA, 100% gives 20mA</td> </tr> <tr> <td>4..20mA</td> <td>0% gives 4mA, 100% gives 20mA</td> </tr> </tbody> </table>							Range	Mapping	0..10V	0% gives 0V, 100% gives 10V	0..20mA	0% gives 0mA, 100% gives 20mA	4..20mA	0% gives 4mA, 100% gives 20mA
Range	Mapping													
0..10V	0% gives 0V, 100% gives 10V													
0..20mA	0% gives 0mA, 100% gives 20mA													
4..20mA	0% gives 4mA, 100% gives 20mA													
Anout 02 Value	0043	Same as PNO 38	0.00	Min to Max	%	ALWAYS								
Terminal X11.4 The desired output value expressed as a percentage of the output range. <table border="1" data-bbox="537 1276 1120 1388"> <thead> <tr> <th>Range</th> <th>Mapping</th> </tr> </thead> <tbody> <tr> <td>-10..10V</td> <td>-100% gives -10V, 100% gives 10V</td> </tr> <tr> <td>0..10V</td> <td>0% gives 0V, 100% gives 10V</td> </tr> </tbody> </table>							Range	Mapping	-10..10V	-100% gives -10V, 100% gives 10V	0..10V	0% gives 0V, 100% gives 10V		
Range	Mapping													
-10..10V	-100% gives -10V, 100% gives 10V													
0..10V	0% gives 0V, 100% gives 10V													

C-104 Parameter Reference

Keypad Override

Parameters::Keypad::Keypad Override

These parameters may be used to modify the behaviour of the Display/Keypad.

Parameter Name	No.	Path	Default	Range	Units	Writable
Green LED Force On	1862	Parameters::Keypad::Keypad Override	FALSE			ALWAYS
When TRUE, turns the LED under the RUN key on. It is not possible to force this LED off when the drive is running.						
Red LED Force Off	1863	Parameters::Keypad::Keypad Override	FALSE			ALWAYS
When TRUE, turns the LED under the STOP key off. It is not possible to force this LED on when the drive is running.						
Disable Keys	1865	Parameters::Keypad::Keypad Override	0000			ALWAYS
Mask to disable the normal operation of the selected keys. The corresponding bits are 2 - UP, 3 - DOWN, 4 - LEFT, 5 - RIGHT, 6 - OK. The mask is ignored when a parameter is being edited, or when an alert message or password entry is active. This parameter is not saved.						
Key Press	1866	Parameters::Keypad::Keypad Override				NEVER
Indicates which key(s) are pressed on the GKP. The corresponding bits are 0 - STOP, 1 - START, 2 - UP, 3 - DOWN, 4 - LEFT, 5 - RIGHT, 6 - OK, 7 - SOFT KEY 1, 8 - SOFT KEY 2						
Selected Parameter	1867	Parameters::Keypad::Keypad Override				NEVER
Shows the PNO of the parameter selected on the GKP. The value is zero when no parameter is selected, or when a parameter is being edited.						

Local Control

Parameters::Keypad::Local Control

These parameters configure the use of the GKP keys for local start / stop control of the drive.

Parameter Name	No.	Path	Default	Range	Units	Writable
Run Key Action	1140	Parameters::Keypad::Local Control	0	0:RUN 1:JOG		STOPPED
<p>Defines the use of the green run key in local mode.</p> <p>When RUN is selected, pressing the green Run key will start the drive using Local Reference as the active setpoint. To stop the drive press the RED Stop key.</p> <p>When JOG is selected, pressing the green Run key will start the drive running using the Jog Setpoint as the active setpoint. The drive will stop when the key is released.</p>						
Local/Rem Key <small>Active</small>	1253	Parameters::Keypad::Local Control	TRUE			ALWAYS
<p>Enables the L/R soft key function. This is used to change between Local and Remote sequencing modes from the GKP.</p>						
Local Dir Key <small>Active</small>	1255	Parameters::Keypad::Local Control	TRUE			ALWAYS
<p>Enables the ability to change the direction from the GKP when running in local sequencing mode. When FALSE the direction will always be positive.</p>						
Local Run Key <small>Active</small>	1239	Parameters::Keypad::Local Control	TRUE			ALWAYS
<p>Enables the green Run key function when in local sequencing mode. When FALSE the Run key is ignored, (for both RUN and JOG modes).</p>						
Local Reverse	1240	Parameters::Keypad::Local Control	FALSE			ALWAYS
<p>Used to change the direction the motor will rotate when in local sequencing mode. When FALSE the direction will be “Forwards”. When TRUE the direction will be reverse.</p>						

C-106 Parameter Reference

Maintenance Monitor

Parameters::Trips::Maintenance Monitor

Monitors various components of the drive. An indication is given if one of more components is near the end of its expected life.

Parameter Name	No.	Path	Default	Range	Units	Writable
Maintenance Warnings	0890	Parameters::Trips::Maintenance Monitor				NEVER
Indicates which components require replacing						
Maintenance Reporting	0891	Parameters::Trips::Maintenance Monitor	FFFF			ALWAYS
Enables the flashing maintenance icon. Clear the corresponding bit to zero to acknowledge the maintenance warning. When the warning is acknowledged the maintenance warning icon on the GKP is still shown, but no longer flashes.						
Maintenance Reset	0892	Parameters::Trips::Maintenance Monitor	0000			ALWAYS
Set the corresponding bit to 1 to reset the recorded age of the component.						
Ambient Temperature	0893	Parameters::Trips::Maintenance Monitor	25.0	-20.0 to 70.0	°C	ALWAYS
Enter the expected ambient temperature around the drive.						

A Warning is generated when any component is within 80% of its expected life.

Identification of drive components

Each of the monitored drive components is represented by a bit in the 16-bit words, "Maintenance Warnings" and "Maintenance Reset". Only the bottom 6 bits of these words have any meaning, the other bits are ignored. The table below indicates which components are selected for a given value.

Value	IO Option Relays	Control Board Relays	Main Fan	Auxiliary Fan	DC Link Capacitors ⁽¹⁾
xxx0		x	x	x	x
xxx1		x	x	x	✓
xxx2		x	x	✓	x
xxx3		x	x	✓	✓
xxx4		x	✓	x	x
xxx5		x	✓	x	✓
xxx6		x	✓	✓	x
xxx7		x	✓	✓	✓
xxx8		✓	x	x	x
xxx9		✓	x	x	✓
xxxA		✓	x	✓	x
xxxB		✓	x	✓	✓
xxxC		✓	✓	x	x
xxxD		✓	✓	x	✓
xxxE		✓	✓	✓	x
xxxF		✓	✓	✓	✓
xx0x	x				
xx1x	✓				

(1) For future use. The DC Link Capacitors are not monitored in version x.16

C-108 Parameter Reference

Minimum Speed

Setup::Application::Minimum Speed

Function availability depends on macro selected.

The minimum speed function is used to determine how the AC30V will follow a reference.

Parameter Name	No.	Path	Default	Range	Units	Writable
Minimum Speed Value	1906	Setup::Application::Minimum Speed	-100.0	-100.0 to 100.0	%	ALWAYS

Specifies the minimum output value.

Minimum Speed Mode	1907	Setup::Application::Minimum Speed	0	0:PROP WITH MINIMUM 1:LINEAR		ALWAYS
---------------------------	------	-----------------------------------	---	---------------------------------	--	--------

There are two modes of operation.

Functional Description

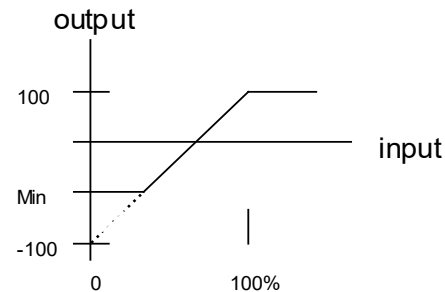

There are two operating modes for the **MINIMUM SPEED** function:

PROP WITH MINIMUM (proportional with minimum)

In this mode the **MINIMUM SPEED** function behaves like a simple clamp. The **Minimum Speed Value** has the valid range -100% to 100% and the output is always greater than or equal to the **Minimum Speed Value**.

LINEAR

In this mode the **MINIMUM SPEED** function first clamps the input to zero then rescales the input such that the output goes linearly between minimum and 100% for an input that goes from 0 to 100%.

Note the constraints:-

- min \geq 0
- input \geq 0
- max = 100%

Modbus

Monitor::Communications::Base Modbus
Setup::Communications::Base Modbus
Parameters::Base Comms::Modbus

[Refer to Appendix A Fieldbuses](#)

C-110 Parameter Reference

Modbus RTU Option

Monitor::Communications::Option

Setup::Communications::Option

Parameters::Option Comms::Comms

Parameters::Option Comms::Read Process

Parameters::Option Comms::Write Process

Parameters::Option Comms::Event

Parameters::Option Comms::Modbus RTU

[Refer to Modbus RTU Technical Manual HA501839U001](#)

Modbus TCP Option

Monitor::Communications::Option
Setup::Communications::Option
Parameters::Option Comms::Comms
Parameters::Option Comms::Read Process
Parameters::Option Comms::Write Process
Parameters::Option Comms::Event
Parameters::Option Comms::Option Ethernet
Parameters::Option Comms::Modbus TCP

[Refer to Modbus TCP Technical Manual HA501937U001](#)

C-112 Parameter Reference

Motor Load

Parameters::Motor Control::Motor Load

Motor Protection, function of the motor type.

The **Motor Load** parameters determines the allowed level of motor overload. This can be especially useful when operating with motors smaller than the drive rating.

For an IM, an IxT protection is used and provides a current reduction if the max overload level is reached.

The max overload level is calculated based on a 150% for 60s.

For a PMAC motor, the motor load is calculated using the rated motor current and the thermal time constant (2 parameters of the PMAC motor module). The Thermal time constant is used as the constant time of a simple 1st order low pass filter.

% Are all related to rated motor current.

Parameter Name	No.	Path	Default	Range	Units	Writable
100% Mot Current	0332	Parameters::Motor Control::Motor Load	x.x	0.0 to 10000.0		NEVER
Motor current in Amps rms corresponding to 100%						
Mot Inv Time Overload	0333	Parameters::Motor Control::Motor Load	x.	0 to 500	%	NEVER
Only available for IM motor						
Overload % of the motor inverse time protection						
Mot Inv Time Delay	0334	Parameters::Motor Control::Motor Load		6.000 to 60.000	s	ALWAYS
Only available for IM motor						
Overload time of the motor inverse time protection from cold state						

Parameter Reference C-113

Parameter Name	No.	Path	Default	Range	Units	Writable
Mot Inv Time Warning	0335	Parameters::Motor Control::Motor Load				NEVER
<p>Only available for IM motor</p> <p>Output information. Becomes TRUE when the overload is 5% of the maximum value before reducing the current</p>						
Mot Inv Time Active	0336	Parameters::Motor Control::Motor Load				NEVER
<p>Only available for IM motor</p> <p>Output information. Becomes TRUE when overload reaches 100% of the overload limit</p>						
Mot Inv Time Output %	0337	Parameters::Motor Control::Motor Load	x.x	0.0 to 600.0	%	NEVER
<p>Only available for IM motor</p> <p>Actual output limit of the inverse time motor protection.</p> <p>This value is compared to the Stack Inv Time current limit output to provide the internal limit to the current limit module.</p>						
Mot I2T TC	0338	Parameters::Motor Control::Motor Load		0.000 to 1000000.000	s	NEVER
<p>Only available for PMAC motor</p> <p>Time constant of the motor, define in the PMAC Motor Data module</p>						
Mot I2T Active	0340	Parameters::Motor Control::Motor Load				NEVER
<p>Only available for PMAC motor</p> <p>Motor load has reached 105%</p>						
Mot I2T Warning	0341	Parameters::Motor Control::Motor Load				NEVER
<p>Only available for PMAC motor</p> <p>Motor load has reached 95%</p>						

C-114 Parameter Reference

Parameter Name	No.	Path	Default	Range	Units	Writable
Mot I2T Enable	0342	Parameters::Motor Control::Motor Load				NEVER

Only available for PMAC motor
 Output information : Motor I2T protection is active.

Functional Description

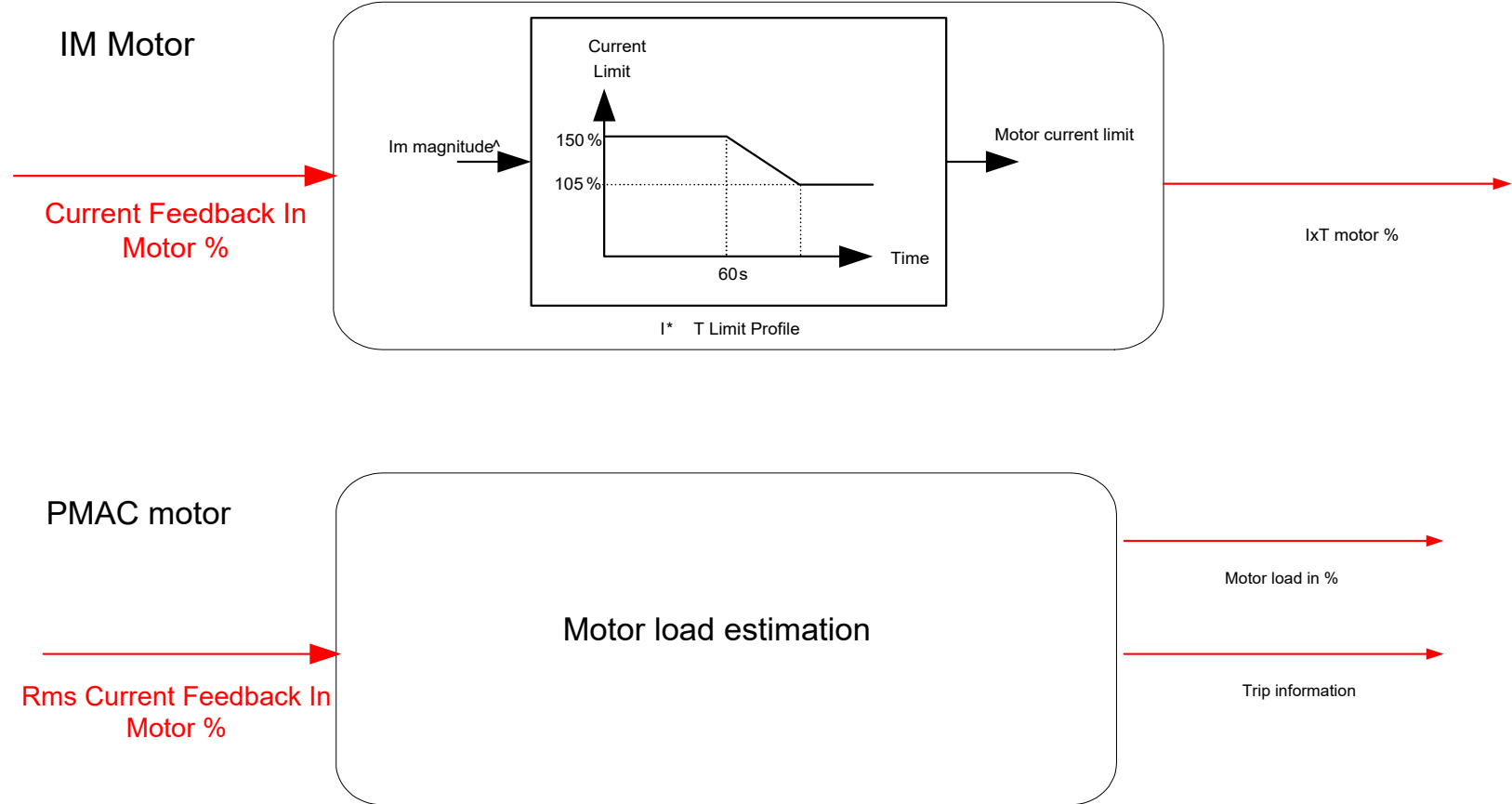

Motor Nameplate

Setup::Motor Control::Motor Nameplate

Parameters::Motor Control::Motor Nameplate

Only available if IM MOTOR selected in **Control Mode**.

In this function you enter the details of the motor under control and any available motor nameplate information.

Refer to Induction Motor Data parameters which are determined by the Auto Tune feature for example the **Magnetising Current, Stator Resistance, Leakage Inductance, Mutual Inductance and Rotor time Constant** for model parameters.

Note Do not attempt to control motors whose rated current is less than 25% of the drive rated current. Poor motor control or Autotune problems may occur if you do.

Parameter Name	No.	Path	Default	Range	Units	Writable
Rated Motor Current	0455	Setup::Motor Control::Motor Nameplate Parameters::Motor Control::Motor Nameplate	1.56	0.00 to 10000.00	A	STOPPED
Rated motor current on the name plate						
Base Voltage	0456	Same as PNO 455	400.00	0.00 to 1000.00	V	STOPPED
The rated motor voltage on the name plate						
Base Frequency	0457	Same as PNO 455	50.00	0.00 to 1000.00	Hz	STOPPED
The base motor frequency on the name plate						
Motor Poles	0458	Same as PNO 455	4,	2 to 1000		STOPPED
Motor poles on the nameplate						
Nameplate Speed	0459	Same as PNO 455	1450.00	0.00 to 100000.00	RPM	STOPPED
Rated motor speed on the name plate						

C-116 Parameter Reference

Parameter Name	No.	Path	Default	Range	Units	Writable
Motor Power	0460	Same as PNO 455	0.75	0.00 to 3000.00	kW	STOPPED
Motor power rating						
Power Factor	0461	Same as PNO 455	0.71	0.00 to 1.00		STOPPED
Only under VHz Control Motor power factor on the name plate						
Automatic Pole Pairs	1214	Same as PNO 455	TRUE			STOPPED
If TRUE Motor Poles (458) calculated automatically from Nameplate Speed (459). If FALSE the user has to input Motor Poles.						

Motor Sequencer

Parameters::Motor Control::Motor Sequencer

These parameters are associated to the internal motor sequencer states machine to start and stop the motor control.

Parameter Name	No.	Path	Default	Range	Units	Writable
Start Delay Enable	1560	Parameters::Motor Control::Motor Sequencer	FALSE			STOPPED
<p>Enable the delay to action “ramping to Setpoint” from the Run Command. This can allow a period for motor flux to establish (AC induction motor) before the ramp to setpoint</p>						
Start Delay	1634	Parameters::Motor Control::Motor Sequencer	0.000	0.000 to 30.000	s	STOPPED
<p>Time to delay the action of “ramping to Setpoint” from the Run Command in seconds.</p>						
Delay To Start	1635	Parameters::Motor Control::Motor Sequencer		0.000 to Max	s	NEVER
<p>Remaining time of the delay before “ramping to Setpoint” after the Run Command occurs.</p>						

C-118 Parameter Reference

MRAS

Parameters::Motor Control::MRAS

These parameters are associated to the internal induction motor speed estimator (MRAS) module.

Parameter Name	No.	Path	Default	Range	Units	Writable
MRAS Speed Percent	286	Parameters::Motor Control::MRAS	x.xx	Min to Max	%	NEVER
Diagnostic parameter that displays speed calculated by the estimator as percent.						
MRAS Speed RPM	1634	Parameters::Motor Control::MRAS	x.xx	0.000 to 30.000	s	NEVER
Diagnostic parameter that displays speed calculated by the estimator as RPM.						
MRAS Field Frequency	1635	Parameters::Motor Control::MRAS	x.xx	0.000 to 30.000	Hz	NEVER
Diagnostic parameter that displays field frequency (electrical frequency) that the estimator provides for vector rotation.						
MRAS Torque Percent	1560	Parameters::Motor Control::MRAS	x.xx	Min to Max	%	NEVER
Diagnostic parameter that displays torque calculated by the estimator as percent.						
MRAS Torque	1634	Parameters::Motor Control::MRAS	x.xx	0.000 to 30.000	Nm	NEVER
Diagnostic parameter that displays torque calculated by the estimator as Nm.						
Switchover Enable	1701 1635	Parameters::Motor Control::MRAS				ALWAYS
A boolean that enables or disables the ability to automatically switch into sensorless operation in the case of an encoder failure. Not on the AC30V						

Functional Description

The Switchover Enable parameter (1701) provides the user with the option to automatically, and as seamlessly as possible, continue operating in sensorless mode in case of an encoder failure. The MRAS estimator tracks the speed of the motor even if the drive uses encoder as its primary feedback for control. If the discrepancy between the speed measured by encoder and the estimated speed is greater than 300 RPM it is assumed that the encoder has malfunctioned and the control will automatically be transferred to use estimated speed as its feedback signal. The drive will continue to work in sensorless mode until the next stop cycle. There will be no attempt to 'reconnect' encoder on the fly even if its signal recovers. Upon the move to sensorless operation a warning will be issued that this has taken place.

The switchover will not be performed, even if enabled, during autotune sequence, if the flycatching is enabled, until the estimator converges to correct speed (typically within first 50-100ms after starting the drive), and until the motor has accelerated to 95% of its initial speed setpoint. The switchover will also not be performed if the setpoint speed is lower than the switchover threshold of 300 RPM.

C-120 Parameter Reference

Parameter Backup

Parameters::Device Manager::Parameter Backup

The parameter backup feature allows you to take a snapshot of a working set of parameters. This may be of particular interest after a successful auto-tune. The parameters may be restored as a complete set or as partial pre-defined groups. The parameter backup feature does not save the drive's configuration.

Parameter Name	No.	Path	Default	Range	Units	Writable
Backup Action	0182	Parameters::Device Manager::Parameter Backup	0	0:SAVE 1:LOAD ALL 2:LOAD POWER 3:LOAD OTHER 4:LOAD AUTOTUNE		ALWAYS
Defines the action that will be started on a change of FALSE to TRUE of Backup-Restore Start. The restore groups are identified in the NOTES in the parameter table at the end of this appendix.						
Backup-Restore Start	0183	Parameters::Device Manager::Parameter Backup	FALSE			ALWAYS
Initiates the selected Backup Action on a change from FALSE to TRUE						
Backup-Restore Status	0184	Parameters::Device Manager::Parameter Backup		0:IDLE 1:SAVING 2:RESTORING 3:VERIFYING 4:DONE 6:FAILED 8:VERIFY FAILED 15:PNET SECTION MISSING		NEVER
Indicates the progress of the backup or restore action.						

Pattern Generator

Parameters::Motor Control::Pattern Generator

The pattern generator function allows you to configure the Drive' PWM (Pulse Width Modulator) operation.

Parameter Name	No.	Path	Default	Range	Units	Writable
Stack Frequency	0412	Parameters::Motor Control::Pattern Generator	4.00	2.00 to 16.00	kHz	ALWAYS

This parameter selects the PWM switching frequency of the output power stack.

The higher the switching frequency, the lower the level of motor audible noise. However, this is only achieved at the expense of increased drive losses and reduced stack current rating.

Max value is **Control Mode** dependant.

Max value is also Stack size dependant.

Max value is also configuration dependant.

8kHz If a Resolver option board is fitted,

9kHz if an AC30A encoder – sincos type is fitted

Max PWM Frequency (kHz)		VHz	PMAC no option	IM no option	PMAC with pulse encoder	IM with pulse encoder	PMAC or IM with resolver	PMAC with Profinet	IM with Profinet
	AC30V	12	10	12	10	12	8		
	AC30P	12	9	10	9	10	8	8	10
	AC30D	12	8	10	8	10	8	8	10
	AC30A	12	9	9	9	9	8	8	9

If the Peer To Peer feature is enabled, then the switching frequency is limited to 8kHz

Max value may also be adapted by the user related to the drive load in term of processing, due to application size and hardware settings.

The user may have to reduce it to get the system working.

Random Pattern IM	0413	Parameters::Motor Control::Pattern Generator	TRUE			ALWAYS
--------------------------	------	--	------	--	--	--------

This parameter selects between random pattern (quiet motor noise) or the more conventional fixed carrier PWM strategies, for induction motor only. When TRUE, random pattern is enabled. For Induction Motor Control, random pattern is only suitable for Stack Frequency <=12kHz. Default value for induction motors is TRUE.

C-122 Parameter Reference

Parameter Name	No.	Path	Default	Range	Units	Writable
----------------	-----	------	---------	-------	-------	----------

Random Pattern PMAC	1268	Parameters::Motor Control::Pattern Generator	FALSE			ALWAYS
----------------------------	------	--	-------	--	--	--------

This parameter selects between random pattern (quiet motor noise) or the more conventional fixed carrier PWM strategies, for PMAC motor only. When TRUE, random pattern is enabled. For PMAC SVC control random pattern is only suitable for Stack Frequency <=8kHz. Default value for PMAC motors is FALSE.

If the Peer To Peer feature is enabled, random pattern is only suitable for Stack Frequency <= 6 kHz

Deflux Delay	0414	Parameters::Motor Control::Pattern Generator	1.000	0.000 to 60.000	s	STOPPED
---------------------	------	--	-------	-----------------	---	---------

Sets the minimum allowed delay between disabling and then re-enabling PWM production (i.e. stopping and starting the drive).

Functional Description

The Drive provides a unique quiet pattern PWM strategy in order to reduce audible motor noise. The user is able to select between the quiet pattern or the more conventional fixed carrier frequency method. With the quiet pattern strategy selected (RANDOM PATTERN enabled), audible motor noise is reduced to a dull hiss.

In addition, the user is able to select the PWM carrier frequency. This is the main switching frequency of the power output stage of the Drive. A high setting of carrier frequency (e.g. 6kHz) reduces audible motor noise but only at the expense of higher Drive losses and smooth motor rotation at low output frequencies. A low setting of carrier frequency (e.g. 3kHz), reduces Drive losses but increases audible motor noise.

Peer to Peer

***Setup::Communications::Peer to Peer
Monitor:: Communications::Peer to Peer
Parameters::Base Comms::Peer to Peer***

Refer to Chapter 8 “Ethernet”.

C-124 Parameter Reference

PID

Setup::Application::PID

Monitor::Application::PID*

This function allows the AC30V to be used in applications requiring a trim to the reference, depending on feedback from an external measurement device. Typically this will be used for process control, i.e. pressure or flow.

Parameter Name	No.	Path	Default	Range	Units	Writable
Setpoint						
This is connected to an Analog Input as part of the selected macro.						
Feedback						
This is connected to an Analog Input as part of the selected macro.						
Enable						
This is connected to a Digital Input as part of the selected macro. It globally resets the PID output and integral term when FALSE. Enable must be TRUE for the PID to operate.						
Integral Defeat						
This may be connected to a Digital Input as part of the selected macro. It resets the p integral term when FALSE.						
PID Setpoint Negate	1926	Monitor::Application::Preset Speeds	REAL	-100.0 to 100.0	%	NEVER
Changes the sign of the Setpoint input						
PID Feedback Negate	1927	Setup::Application::PID	BOOL			ALWAYS
Changes the sign of the Negate input						
PID Proportional Gain	1928	Setup::Application::PID	REAL			ALWAYS
This is the true proportional gain of the PID controller. When set to zero the PID Output is zero.						

Functional Description

Parameter Reference C-125

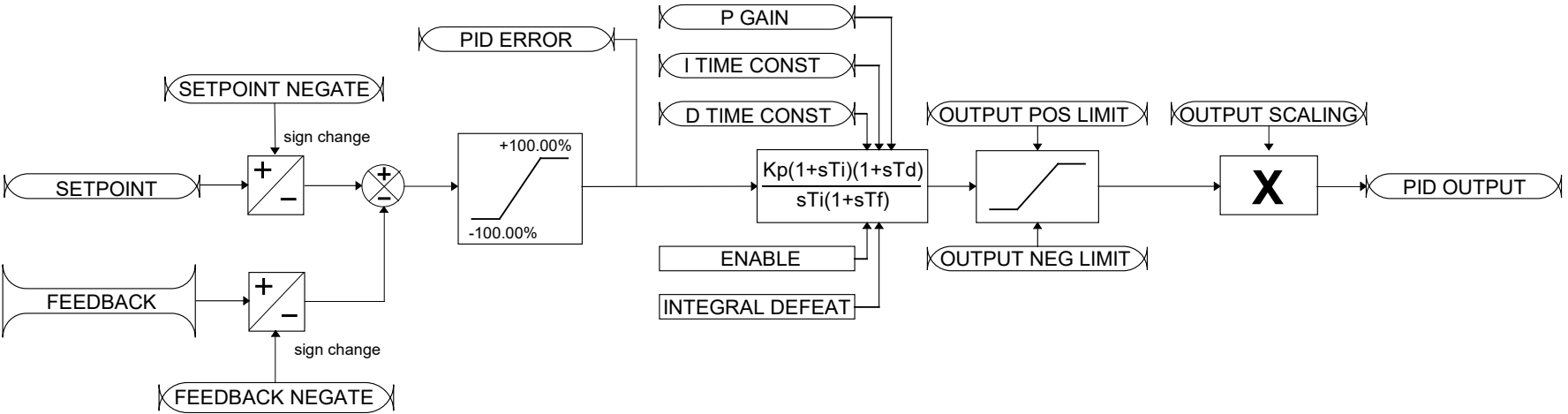

C-126 Parameter Reference

PMAC Flycatching

Parameters::Motor Control::PMAC Flycatching

Only available if PMAC MOTOR selected in **Control Mode**.

This block performs a directional speed search. It allows the Drive to seamlessly catch a spinning motor before controlling the motor to the desired setpoint. This is especially useful for large inertia fan loads, where drafts in building air ducts can cause a fan to 'windmill'.

Parameter Name	No.	Path	Default	Range	Units	Writable
PMAC Flycatching Enable	0689	Parameters::Motor Control::PMAC Flycatching	FALSE			ALWAYS

Enable the flycatching for PMAC motor

PMAC Fly Search Mode	0690	Parameters::Motor Control::PMAC Flycatching	0	Same as PNO 312		ALWAYS
-----------------------------	------	---	---	-----------------	--	--------

The PMAC Flycatching sequence can be triggered by different starting conditions:

ALWAYS: All starts (after controlled or uncontrolled stop, or after a power-up)

TRIP or POWER-UP: After uncontrolled stop, i.e. trip or coast, or after a power-up

TRIP: After uncontrolled stop, i.e. trip or coast

PMAC Fly Search Time	0691	Parameters::Motor Control::PMAC Flycatching	0.200	0.100 to 60.000	s	ALWAYS
-----------------------------	------	---	-------	-----------------	---	--------

PMAC Fly Search Time to catch the right speed

PMAC Fly Load Level	0692	Parameters::Motor Control::PMAC Flycatching	5.0	-50.0 to 50.0	%	ALWAYS
----------------------------	------	---	-----	---------------	---	--------

PMAC Fly Load Level during fly catching

PMAC Fly Active	0693	Parameters::Motor Control::PMAC Flycatching				NEVER
------------------------	------	---	--	--	--	-------

Diagnostic to show if the PMAC fly catching is active or inactive

Parameter Reference C-127

Parameter Name	No.	Path	Default	Range	Units	Writable
PMAC Fly Setpoint	0694	Parameters::Motor Control::PMAC Flycatching	x.	-1000 to 1000	Hz	NEVER

PMAC Fly Setpoint

Functional Description

The flycatching function enables the drive to be restarted smoothly into a spinning motor.

C-128 Parameter Reference

PMAC Motor Advanced

Parameters::Motor Control::PMAC Motor Advanced

Only available if PMAC Motor selected in **Control Mode**.

The PMAC Motor Advanced allows to move the current setpoint of a PMAC Motor to the D and Q axis, adding a predictive phase shift to the current. The phase shift is proportional to the current level.

By default, values are set to Zero.

Only change values if data are from the motor manufacturer.

Parameter Name	No.	Path	Default	Range	Units	Writable
Phase at Rated Current	1858	Parameters::Motor Control::PMAC Motor Advanced	0.0	0.0 to 90.0	deg	STOPPED

Phase advance in electrical degrees on current at rated current level. The value applied is proportional to the current level.

The current setpoint is separated into D and Q axis :

Cos of the angle is applied to the Q axis.

Sin of the angle is applied to the D axis.

Max Phase	1859	Same as PNO 1858	0.0	0.0 to 90.0	deg	STOPPED
------------------	------	------------------	-----	-------------	-----	---------

Max phase advance applied to the current.

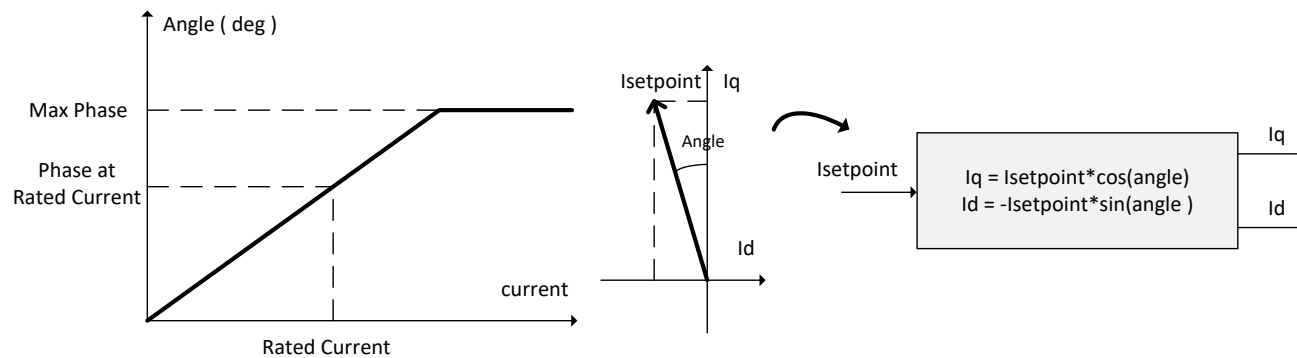

PMAC Motor Data

Setup::Motor Control::MotorData PMAC
Parameters::Motor Control::PMAC Motor Data

Only available if PMAC Motor selected in **Control Mode**.

The PMAC Motor Data contains the parameters needed to run and control of a PMAC motor. A PMAC motor is a Permanent Magnet AC Motor with sinusoidal back EMF.

Parameter Name	No.	Path	Default	Range	Units	Writable
PMAC Max Speed	0555	Setup::Motor Control::Motor Data PMAC Parameters::Motor Control::PMAC Motor Data	3000	0 to 100000	RPM	ALWAYS
Set the motor's rated speed in rpm.						
PMAC Max Current	0556	Same as PNO 555	4.50	0.00 to 5000.00	A	ALWAYS
Set the motor's maximum current (Amps rms).						
PMAC Rated Current	0557	Same as PNO 555	4.50	0.00 to 5000.00	A	ALWAYS
Set the motor's rated current (Amps rms). Refer to Motor Current Percent in the Feedbacks function. A value of 100% = PMAC rated Current.						
PMAC Rated Torque	0558	Same as PNO 555	4.50	0.00 to 30000.00	Nm	ALWAYS
Set the motor's rated torque. Refer to Actual Torque in the Feedbacks function. A value of 100% = PMAC Rated Torque.						
PMAC Motor Poles	0559	Same as PNO 555	10	0 to 400		ALWAYS
Set the number of motor poles, e.g. for a 4 poles motor enter "4".						
PMAC Back Emf Const KE	0560	Same as PNO 555	60.0	0.0 to 30000.0	V	ALWAYS

C-130 Parameter Reference

Parameter Name	No.	Path	Default	Range	Units	Writable
Set the motor's Back EMF line to line, rms value (Ke, Volts rms per 1000 rpm)						
PMAC Winding Resistance	0561	Same as PNO 555	6.580	0.000 to 500.000	Ohm	ALWAYS
Set the motor's resistance, line to line at 25 °C.						
PMAC Winding Inductance	0562	Same as PNO 555	20.00	0.00 to 1000.00	mH	ALWAYS
Set the motor's inductance line to line at maximum current. This parameter is used within the current loop and is related to the overall proportional gain.						
PMAC Torque Const KT	0563	Same as PNO 555	1.00	0.00 to 10000.00	Nm/A	ALWAYS
Torque constant (Kt, Nm/A rms). This parameter is used to compute the current demand given a torque demand : Torque demand = KT x Current demand						
PMAC Motor Inertia	0564	Same as PNO 555	0.00100	0.00000 to 100.00000	kgm ²	ALWAYS
Rotor inertia of motor.						
PMAC Therm Time Const	0565	Same as PNO 555	62.000	0.000 to 10000.000	s	ALWAYS
Copper Thermal Time constant(s). If not known set to 300s. This parameter is used for the motor thermal protection : Refer to Motor Load module. It represents the time needed to reach 63% of the rated load of the motor if 100% of the rated current is applied to the motor (typical time constant of a first order low pass filter).						

Parameter Reference C-131

Parameter Name	No.	Path	Default	Range	Units	Writable
PMAC Base Volt	1387	Setup::Motor Control::Motor Data PMAC Parameters::Motor Control::PMAC Motor Data	400.00	0.00 to 1000.00	V	ALWAYS
Rated motor rated voltage in Volt rms						
PMAC Encoder Offset	1808	Setup::Motor Control::Motor Data PMAC Parameters::Motor Control::PMAC Motor Data	0.0	-180.0 to 180.0	deg	ALWAYS
<p>Only available if 1533 Control Type = ENCODER FEEDBACK</p> <p>Electrical position Offset between encoder Zero position and motor Back EMF</p> <p>Automatically set up if Alignment sequence runs and completed</p>						
PMAC Wiring	1809	Setup::Motor Control::Motor Data PMAC Monitor::Motor and Drive Parameters::Motor Control::PMAC Motor Data	0	Same as PNO 1804		ALWAYS
<p>Only available if 1533 Control Type = ENCODER FEEDBACK</p> <p>Wiring direction of the motor phase :</p> <ul style="list-style-type: none"> - STANDARD : U V W - REVERSE : U W V <p>Allow to change connection of phase V and W internally to the drive. No external action required.</p> <p>Automatically set up if Alignment sequence runs and completed.</p> <p>Changing this parameter will change the direction of motor rotation. Please verify if the new direction is compatible with your application.</p>						

C-132 Parameter Reference

Functional Description

By definition, the motor Vector Control is based on the assumption that the back EMF is crossing the 0V line in a positive direction when the electrical position is also crossing the 0° line in a positive way. Another requirement is to insure a positive 'encoder/resolver' rotation with a positive electrical motor rotation (U, V, W).

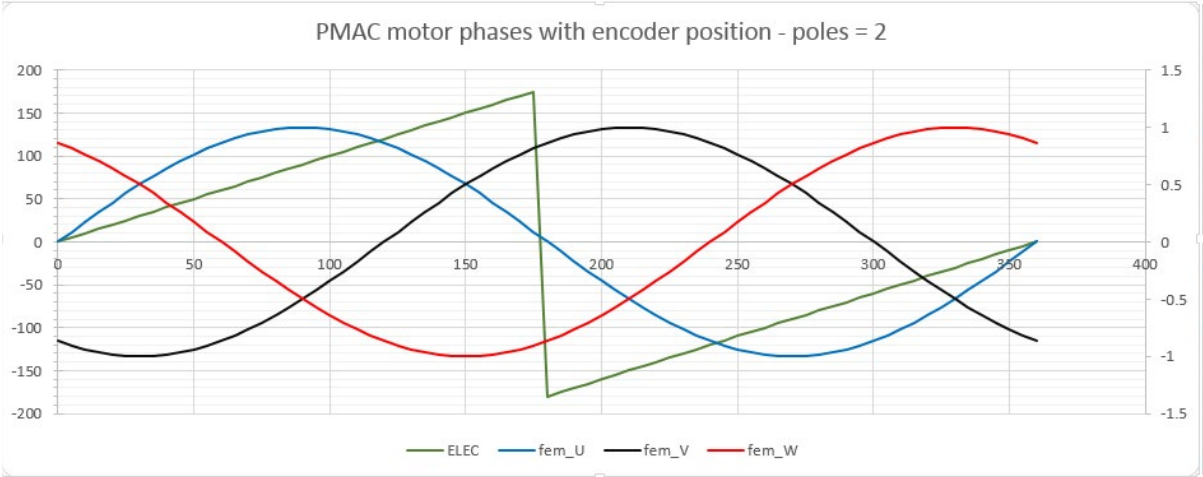

PMAC SVC**Parameters::Motor Control::PMAC SVC**

Only available if PMAC MOTOR selected in **Control Mode**.

Parameters related to the **SVC Control mode** of a PMAC Motor

Parameter Name	No.	Path	Default	Range	Units	Writable
PMAC SVC Auto Values	0467	Parameters::Motor Control::PMAC SVC	TRUE			ALWAYS

Selection of pre-calculated values

When selected, do some pre-calculations of the following PMAC SVC parameters:

PMAC SVC LPF Speed Hz**PMAC SVC P Gain****PMAC SVC I Gain Hz**

PMAC SVC LPF Speed Hz	0468	Parameters::Motor Control::PMAC SVC	60.00	0.00 to 10000.00	Hz	ALWAYS
------------------------------	------	-------------------------------------	-------	------------------	----	--------

Set the Low Pass Filter frequency of the estimated speed.

PMAC SVC P Gain	0469	Parameters::Motor Control::PMAC SVC	2.42	0.00 to 10000.00		ALWAYS
------------------------	------	-------------------------------------	------	------------------	--	--------

Set the Proportional gain of the PI corrector used for extracting speed and position.

PMAC SVC I Gain Hz	0470	Parameters::Motor Control::PMAC SVC	20.00	0.00 to 10000.00	Hz	ALWAYS
---------------------------	------	-------------------------------------	-------	------------------	----	--------

Set the Integral frequency of the PI corrector used for extracting speed and position.

PMAC SVC Open Loop Strt	0476	Parameters::Motor Control::PMAC SVC	TRUE			ALWAYS
--------------------------------	------	-------------------------------------	------	--	--	--------

This parameter is used to enable/disable a specific startup procedure when the motor/drive is switched ON (starting rotation). This parameter is also used to work in up – down motion, where we need to go down to zero speed or crossing the zero speed point.

When set TRUE, the following procedure is applied each time the motor is switched on and before closing the speed loop, based on the external speed setpoint.

C-134 Parameter Reference

Parameter Name	No.	Path	Default	Range	Units	Writable
-----------------------	------------	-------------	----------------	--------------	--------------	-----------------

The drive must be used in speed loop mode.

When the drive is switched ON, the system is placed in open loop control.

Step 1:

For a time equal to the 'PMAC SVC Start Time' parameter, the current is ramped to the **PMAC SVC Start Cur** value. The sign is dependent upon the speed loop setpoint. A normal value is between 0.5 to 1s.

Step 2:

Once Step 1 is complete, the position is ramped in such a way as to follow the speed setpoint generated, based on the configuration (ramp, etc...), until the **PMAC SVC Start Speed** value is reached. The speed loop is then closed.

The ramp value must be kept low to ensure the motor follows the speed setpoint.

For a positive speed setpoint when the drive is switched ON :

Parameter Name	No.	Path	Default	Range	Units	Writable
----------------	-----	------	---------	-------	-------	----------

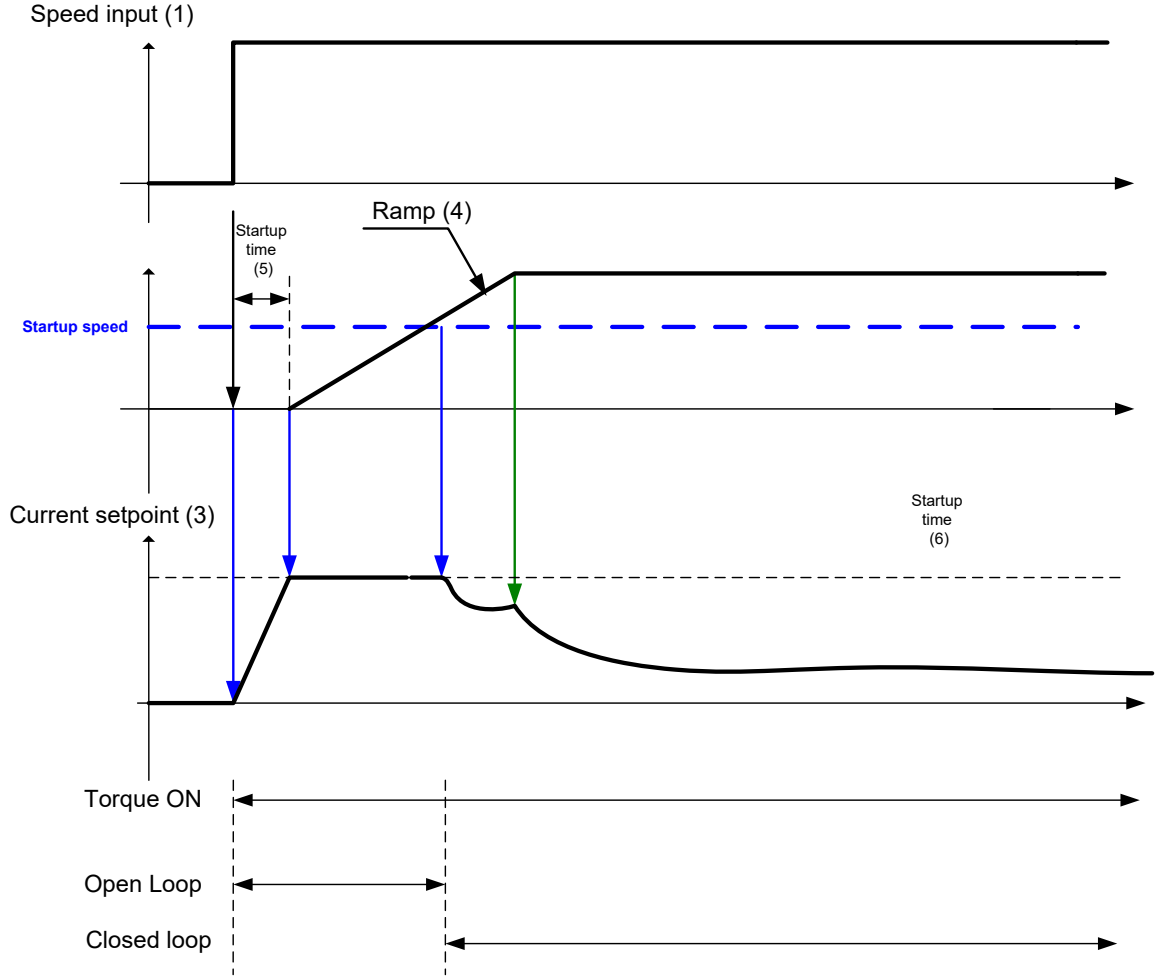

- (1) : User speed setpoint
- (2) : Internal speed setpoint
- (3) : Internal current setpoint
- (4) : ramps are generated based on ramp parameters
- (5) : startup procedure : a current is smoothly installed into the motor
- (6) : startup procedure : the motor is rotated for one electrical turn

C-136 Parameter Reference

Parameter Name	No.	Path	Default	Range	Units	Writable
----------------	-----	------	---------	-------	-------	----------

For a negative speed setpoint when the drive is switched ON :

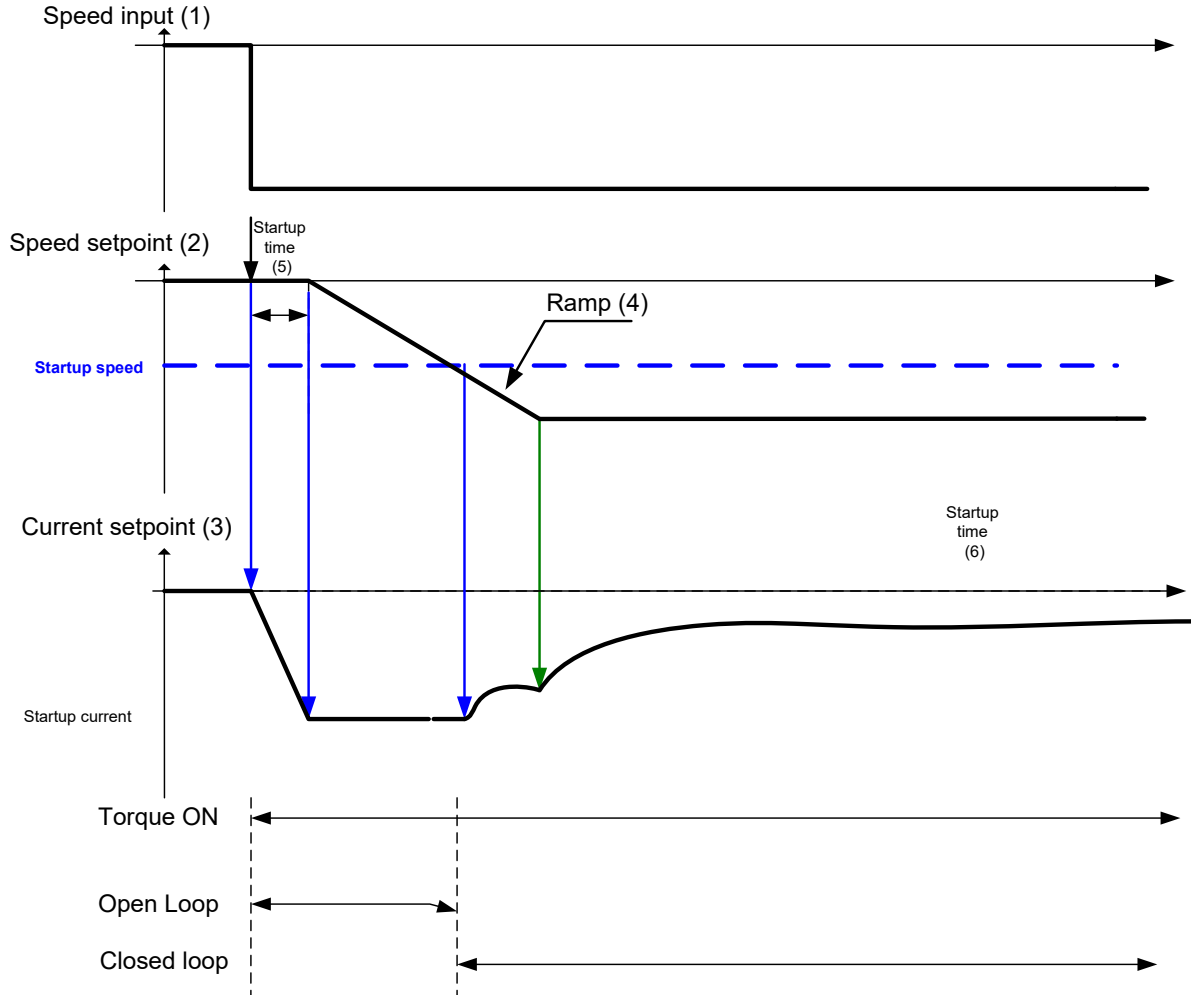

- (1) : User speed setpoint
- (2) : Internal speed setpoint
- (3) : Internal current setpoint
- (4) : ramps are generated based on ramp parameters
- (5) : startup procedure : a current is smoothly installed into the motor
- (6) : startup procedure : the motor is rotated for one electrical turn

Parameter Name	No.	Path	Default	Range	Units	Writable
PMAC SVC Start Time	0477	Parameters::Motor Control::PMAC SVC	0.500	0.000 to 1000.000	s	ALWAYS

This parameter is used in conjunction with the **PMAC SVC Open Loop Strt** parameter. It selects the duration of Step 1 in the startup procedure used for starting motors:

The value should be set up relatively to the motor inertia + load inertia.

PMAC SVC Start Cur	0478	Setup::Motor Control::SVC PMAC Parameters::Motor Control::PMAC SVC	10.0	0.0 to 600.0	%	ALWAYS
---------------------------	------	---	------	--------------	---	--------

This parameter is used in conjunction with the **PMAC SVC Open Loop Strt** parameter. It selects the current level during the startup procedure used for starting motors.

The percentage value is a percentage of the nominal motor current (**PMAC Rated Current** of the **PMAC Motor Data** functions).

The default value of 10% is considered appropriate for most applications with light load, very low friction and low acceleration.

The value should be adapted to the starting conditions.

PMAC SVC Start Speed	0479	Same as PNO 478	5	0 to 200	%	ALWAYS
-----------------------------	------	-----------------	---	----------	---	--------

This parameter is used in conjunction with the **PMAC SVC Open Loop Strt** parameter. It selects the speed setpoint at which the speed control is switched from an open loop mode to a closed loop mode during the startup procedure used for starting motors.

The percentage value is a percentage of the maximum application speed (**100% Speed in RPM** of the **Scale Setpoint** functions). It should be set to an equivalent of 5% of the **PMAC Max Speed** of **PMAC Motor Data** function.

In open loop mode, the system is not controlled in speed mode. It must only be used to 'start' the motor under heavy conditions, or to transitorily reach the zero speed or crossing the zero speed setpoint. It is not intended to be used to control accurately a motion.

C-138 Parameter Reference

Parameter Name	No.	Path	Default	Range	Units	Writable
----------------	-----	------	---------	-------	-------	----------

Up and Down Motion - Positive speed

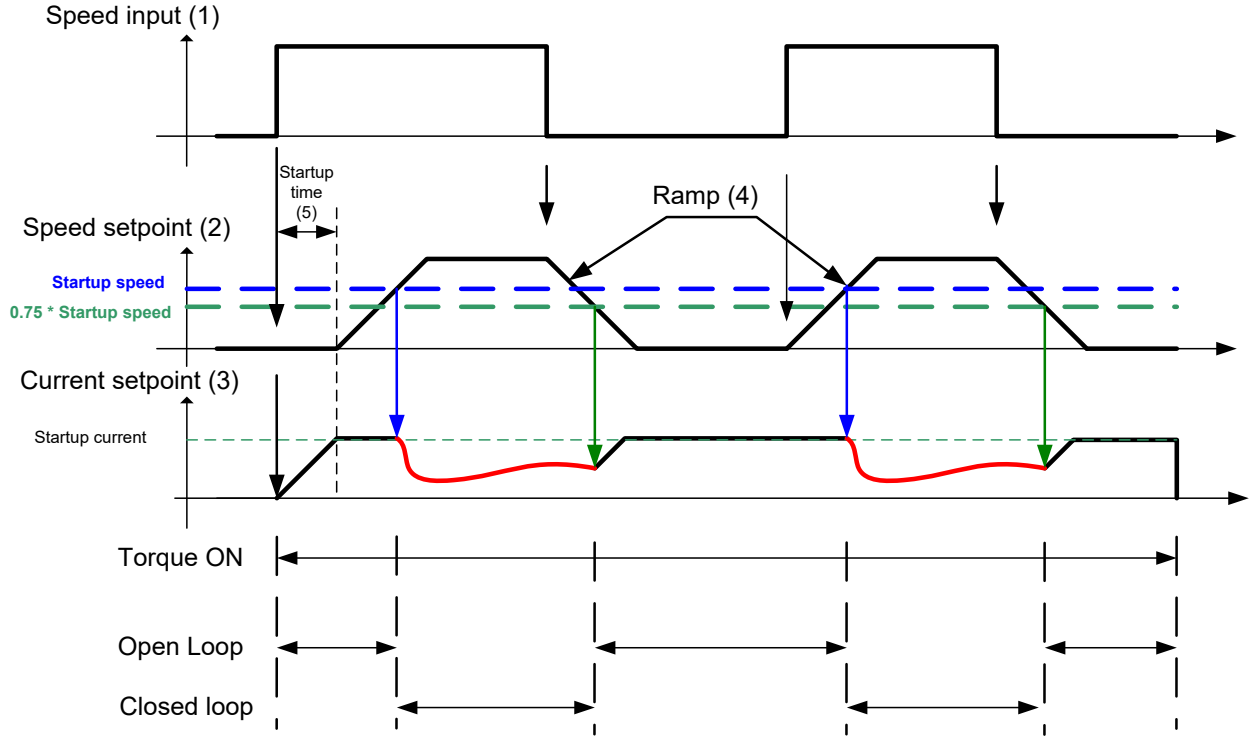

- (1) : User speed setpoint
- (2) : Internal speed setpoint
- (3) : Internal current setpoint
- (4) : ramps are generated based on ramp parameters
- (5) : startup procedure : a current is smoothly installed into the motor

Parameter Name	No.	Path	Default	Range	Units	Writable
----------------	-----	------	---------	-------	-------	----------

Negative Speed

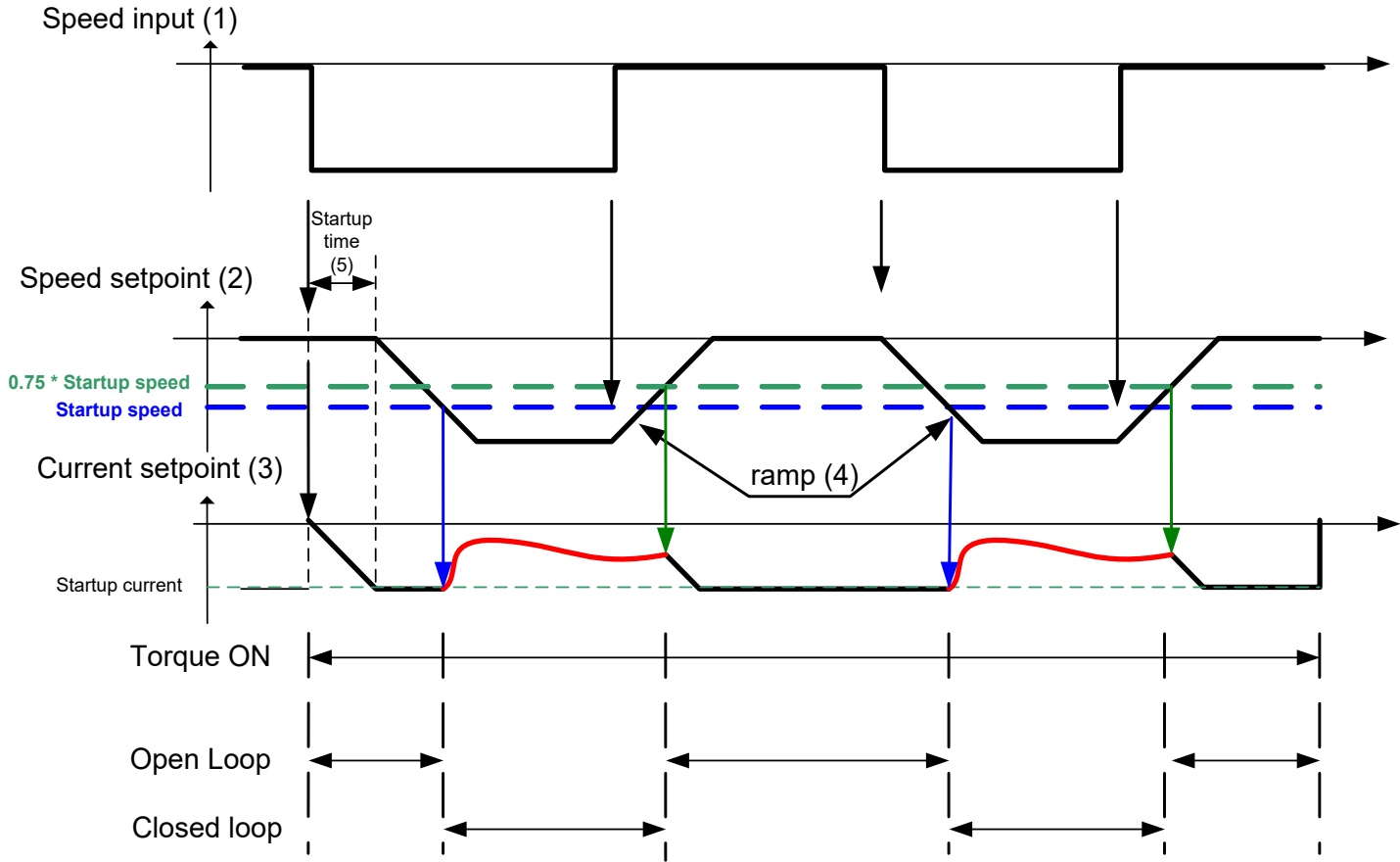

- (1) : User speed setpoint
- (2) : Internal speed setpoint
- (3) ; Internal current setpoint
- (4) : ramps are generated based on ramp parameters
- (5) : startup procedure : a current is smoothly installed into the motor

C-140 Parameter Reference

Parameter Name	No.	Path	Default	Range	Units	Writable
----------------	-----	------	---------	-------	-------	----------

Crossing zero speed

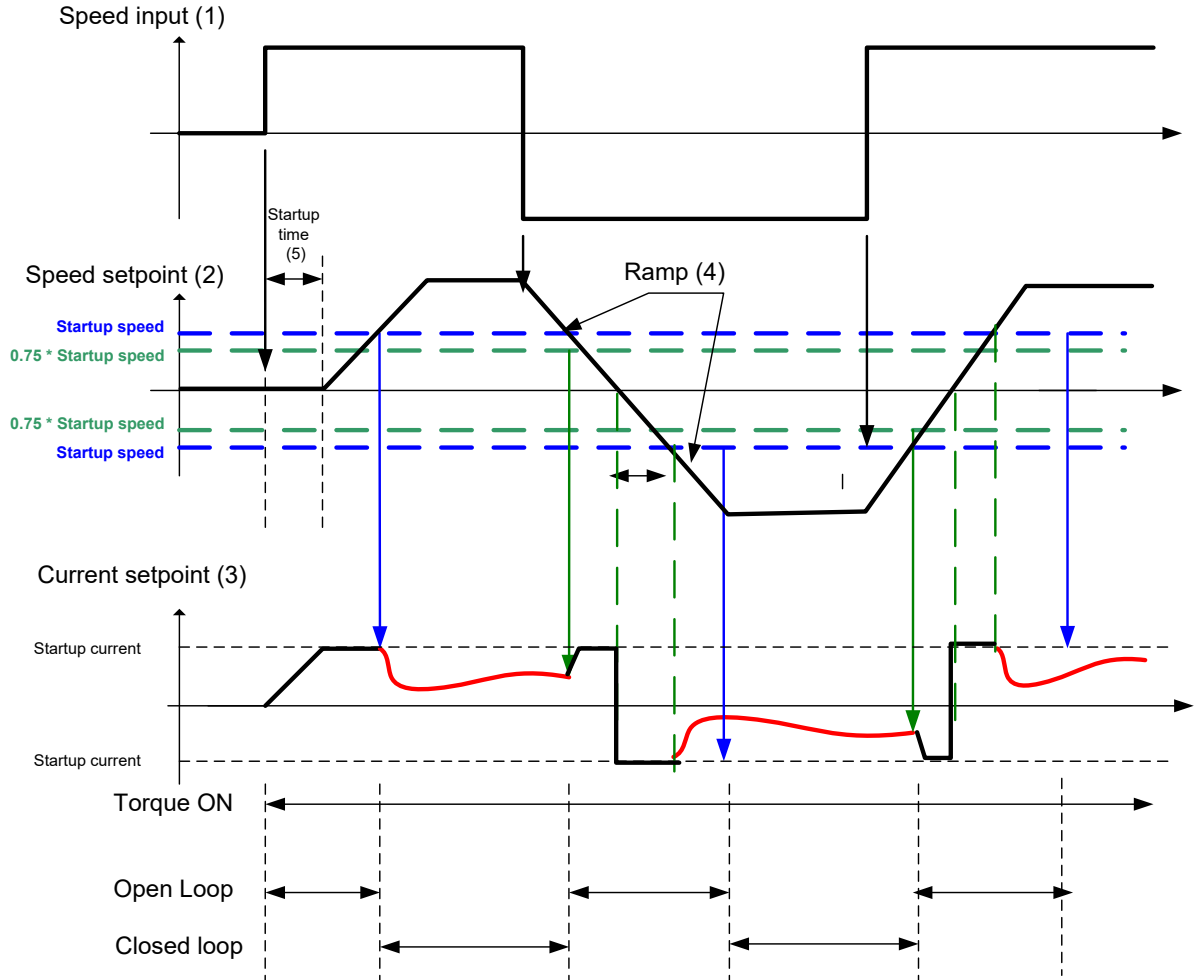

- (1) : User speed setpoint
- (2) : Internal speed setpoint
- (3) : Internal current setpoint
- (4) : ramps are generated based on ramp parameters
- (5) : startup procedure : a current is smoothly installed into the motor
- (6) : zero crossing for the speed input : the current must be inverted into the motor

Pos Fbk Alignment

Parameters::Motor Control::Pos Fbk Alignment

Only available if PMAC MOTOR selected in **Control Mode** and **Control Type** set to ENCODER FEEDBACK .

Vector Control of a PMAC motor needs to know the relative position between the rotor and the stator.

By definition, the AC30 Vector Control for a PMAC Motor is based on the assumption that the motor back EMF is crossing the 0V line in a positive direction when the electrical position is also crossing the 0° line in a positive way. Another requirement is to insure a positive ‘encoder/resolver’ rotation with a positive electrical motor rotation (U, V, W).

This feature is used to automatically calculate any offset between the encoder absolute position and the motor back EMF, as well as selecting the correct wiring of the motor (U, V, W sequence) with the encoder position.

The feature needs to be run at least once with a PMAC motor associated to an absolute encoder type.

The feature needs to be run after each power cycle with a PMAC motor associated to a relative encoder type (pulse encoder for example)

The feature is run on a motor free to rotate, no load attached to the motor shaft.

Regardless of the Alignment Method selected, the motor should move during the sequence.

If Alignment Method is set to AUTOMATIC, it is possible that the direction of motor rotation for a positive setpoint could be reversed. The parameter 1809 PMAC Wiring can be changed and overwritten by the sequence if an incompatibility of direction between the encoder and the motor phases wiring is found.

Parameter Name	No.	Path	Default	Range	Units	Writable
Alignment Enable	1798	Setup::Motor Control::Pos Fbk Alignment Parameters::Motor Control::Pos Fbk Alignment	FALSE			STOPPED
Enable the Alignment sequence.						
Alignment On Power On	1796	Setup::Motor Control::Pos Fbk Alignment Parameters::Motor Control::Pos Fbk Alignment	FALSE			STOPPED

C-142 Parameter Reference

Parameter Name	No.	Path	Default	Range	Units	Writable
----------------	-----	------	---------	-------	-------	----------

Set to TRUE, this parameter automatically trips the drive after a power up on a Start command until an Alignment sequence is run and completed successfully.

This is useful when the PMAC motor is associated to a relative encoder type and the position synchronism between encoder and motor is lost due to power off.

Alignment On Power On	1797	Setup::Motor Control::Pos Fbk Alignment Parameters::Motor Control::Pos Fbk Alignment	FALSE	0 : MANUAL 1 : AUTOMATIC 2 : DIRECTION TEST		STOPPED
------------------------------	------	---	-------	---	--	---------

Each Method is extensively described in the [Functionnal Description](#).

MANUAL :

allows to place the motor in the selected position defined by the parameter "Alignment On Motor". This method should be selected for multi poles resolver with non integer value.

AUTOMATIC:

Sequence runs automatically by the drive, on a start command from the user.

Allows to set up correctly the 'encoder/resolver' and the motor by :

- Changing the motor phase connection of phase V and W internally to the drive if a mismatch is found between 'encoder/resolver' positive direction and positive motor electrical position
- Automatically calculate the offset of position to align zero 'encoder/resolver' to U motor phase.

DIRECTION TEST :

Allows to verify the direction of positive electrical position by slowly rotating the motor. A correct wiring of the motor phases should turn the motor in a clockwise direction looking at the front shaft of the motor

Alignment Level	1799	Same as PNO 1796	50	0 to 150	%	ALWAYS
------------------------	------	------------------	----	----------	---	--------

Level of current applied to the motor.

Motor amps% of rated motor amps, limited to rated drive amps

Parameter Reference C-143

Parameter Name	No.	Path	Default	Range	Units	Writable
Alignment Ramp Time	1800	Same as PNO 1796	1.000	0.000 to 30.000	s	ALWAYS
Time to install the amps into the motor phase with a linear ramp.						
Alignment On Motor	1801	Same as PNO 1796	0	0:PHASE U 1:PHASE V 2:PHASE W		ALWAYS
Selection of the motor phase when MANUAL method is selected. Can be <u>PHASE U</u> : “Alignment Elec Pos” should be 90° - <u>PHASE V</u> : “Alignment Elec Pos” should be 210° or -150° <u>PHASE W</u> : “Alignment Elec Pos” should be 330° or -30°						
Alignment Offset	1802	Parameters::Motor Control::Pos Fbk Alignment	x.x	-180.0 to 180.0	deg	NEVER
Represents the offset value needed to align Zero position to motor Back EMF <u>MANUAL</u> : Value is calculated and passed back to 1808 PMAC Encoder Offset . <u>AUTOMATIC</u> : Value that has been applied to align the ‘encoder/resolver’ to the motor phase U with controls on position and motor phases. If the Alignment is completed, then this parameter is written back to 1808 PMAC Encoder Offset						
Alignment Elec Pos	1803	Parameters::Motor Control::Pos Fbk Alignment	x.x	-180.0 to 180.0	deg	NEVER
Actual electrical position						
Alignment Direction	1804	Parameters::Motor Control::Pos Fbk Alignment		0:STANDARD 1:REVERSE		NEVER

C-144 Parameter Reference

Parameter Name	No.	Path	Default	Range	Units	Writable
----------------	-----	------	---------	-------	-------	----------

Wiring direction of the motor phase :

- STANDARD : U V W : position and phase U V W are rotating in the same direction
- REVERSE : U W V : position and phase U V W are not rotating in the same direction. V and W have been inverted internally to the drive.

If the Alignment is completed, then this parameter is written back to **1809 PMAC Wiring**

Alignment State	1805	Parameters::Motor Control::Pos Fbk Alignment		0:OFF 1:ON MANUAL 2:ON AUTO 3:ERROR 4:ENDED		NEVER
------------------------	------	---	--	---	--	-------

State of Alignment sequence :

OFF : No Alignment sequence

ON MANUAL : **Alignment Method** = MANUAL or DIRECTION TEST + **Alignment Enable** = TRUE.

ON AUTO : **Alignment Method** = AUTOMATIC + **Alignment Enable** = TRUE.

ERROR : An error occurred during the Alignment. See Alignment error for possible diagnostics

ENDED : When Alignment sequence is run and successfully completed

Alignment Ended	1806	Parameters::Motor Control::Pos Fbk Alignment				NEVER
------------------------	------	---	--	--	--	-------

TRUE : Alignment sequence ended successfully.

FALSE : No Alignment sequence or Alignment sequence in progress

Parameter Reference C-145

Parameter Name	No.	Path	Default	Range	Units	Writable
Alignment Error	1807	Parameters::Motor Control::Pos Fbk Alignment		0:NO ERROR 1:SHAFT LOCKED 2:AMPS 3:LOAD 4:POLES 5:MOTOR UNCONNECTED 6:ENCODER 7:INIT NEEDED		NEVER

Details of the last error recorded.

Reset to NO ERROR by running a new Alignment sequence.

NO ERROR : Everything ok. Alignment sequence is running

SHAFT LOCKED : the drive is locked in position.

AMPS : Not enough Amps to move the motor. **Alignment Level too small**

LOAD : Not enough Amps to move the motor. Is the motor free to rotate? Is there a load on the motor?

POLES : Bad motor poles number.

MOTOR UNCONNECTED : Motor phases disconnected. Verify the motor wiring

ENCODER : Something wrong detected on encoder speed and/or position.

INIT NEEDED : When **Alignment On Power On** = TRUE and a Start command has been detected. The drive should have tripped on **46 PMAC ALIGN ERROR**

C-146 Parameter Reference

Functional Description

The feature needs to be run after each power cycle with a PMAC motor associated to a relative encoder type (pulse encoder for example).

The feature is run on a motor free to rotate, no load attached to the motor shaft.
Regardless of the Alignment Method selected, the motor should move during the sequence.

The sequence is validated by **Alignment Enable** input.
The drive waits for a START condition to start the cycle.
The sequence can be stopped by a STOP command anywhere during the cycle.
A successful sequence sets **Alignment Ended = TRUE**.

A TORQUE OFF command is needed to stop the sequence.

If Alignment Method is set to AUTOMATIC, it is possible that the direction of motor rotation for a positive setpoint could be reversed. The parameter PMAC Wiring can be changed by the sequence if an incompatibility of direction between the encoder and the motor phases wiring is found.

Alignment Method = MANUAL

The motor is moved to an electrical position corresponding to the motor phase selected by **Alignment On Motor** parameter.
This electrical position depends on the PMAC Wiring type selected and on the real motor phase wiring.

PMAC Encoder Offset is calculated by looking at real position from the active encoder compared to theoretical position where the motor is.
So, it depends also on the encoder settings (inverted or not).

For standard connections (correct U, V, W motor wiring sequence and position from encoder varying in a positive way looking at the motor front shaft), position offset is extracted and written back into PMAC Encoder Offset.

Correct connection of the encoder means that a clockwise rotation of the motor front shaft equals a positive position variation.

Correct motor wiring means phase U, V, W rotating in a correct sequence for a clock wise rotation of the motor front shaft.

Considering a standard connection, the following table gives possible encoder and **PMAC Wiring** settings and results on speed control :

1809 PMAC Wiring	Active Encoder Invert*	Correct speed control	Positive Speed setpoint **
STANDARD	FALSE	YES	Clockwise direction
STANDARD	TRUE	NO***	
REVERSE	FALSE	NO***	
REVERSE	TRUE	YES	Counter clockwise direction

* Active Encoder Invert refers to the active speed feedback invert parameter.

** Looking the front shaft of the motor

*** **The motor is uncontrolled. It could overspeed, be stalled, or running at constant speed without any control.**

Alignment Method = DIRECTION TEST

The motor is slowly rotates with the following sequence U, V, W, U, V, W.....

It allows to verify the rotation direction and detect any wiring inversion on the motor phases.

Active encoder Invert parameter has no effect during this test.

Looking at the position form the active encoder may help to know if the active encoder is correctly wired.

Considering a correct connection of the motor phases :

1809 PMAC Wiring	Motor Rotation direction
STANDARD	Clockwise
REVERSE	Counter Clockwise

When running this Method, either set **1257 Seq Stop Method** to DISABLE VOLTAGE or **0505 Zero Speed Threshold** to 1% otherwise you may end up with a motor rotating at slow speed for 60s without any possibility to stop it.

Alignment Method = AUTOMATIC

In case of a correct wiring of encoder and/or motor phases, the sequence is as follows :

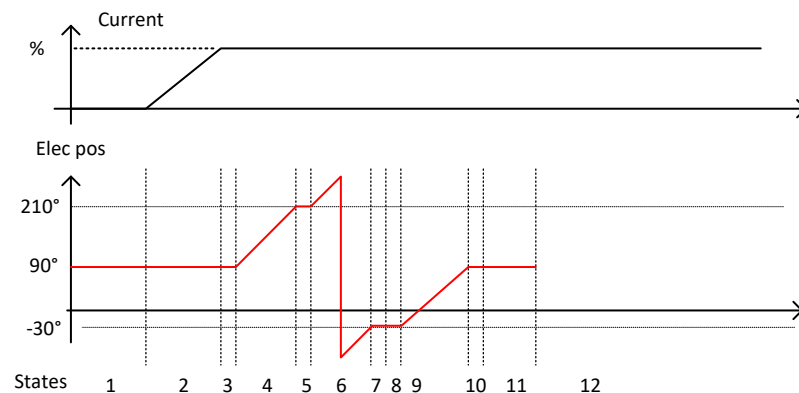

During the final state (11), the Alignment Offset is automatically calculated and is passed back to **1808 PMAC Encoder Offset**
 Also **1809 PMAC Wiring** is set to STANDARD

C-148 Parameter Reference

In the case of a wrong wiring of encoder and/or motor phases, the sequence is as follows :

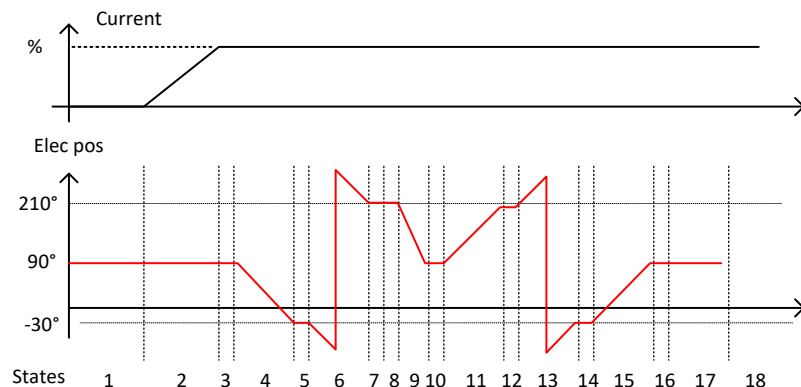

From State 4 to 9, a wrong direction as been detected, and the direction should be reverted. **Alignment Direction** is set to REVERSE. During the final state (17), the Alignment Offset is automatically calculated and is passed back to **1808 PMAC Encoder Offset** Also **1809 PMAC Wiring** is set to REVERSE.

In that case, the direction of motor rotation has been changed during the Pos Alignment sequence. Please verify if the new direction is compatible with your application.

If you want to change it, please change the Invert parameter of the active encoder used to control the motor and run again the Pos alignment sequence.

Drive settings during Pos Alignment :

Some errors may occur during the Alignment sequence which are related to the setting of the drive. Please be aware of the following

- It's better to run it with a speed setpoint at 0% (Speed Error could end up the sequence before end)
- When running **Alignment Method = DIRECTION TEST**, either set **1257 Seq Stop Method** to DISABLE VOLTAGE or **0505 Zero Speed Threshold** to 1%
- When a resolver is used, the filter on the speed should be left at default values or set to good known values.

Power Loss Ride Thru

Parameters::Motor Control::Power Loss Ride Thru

The block controls the behaviour of the drive during a power outage.

When enabled, the drive attempts to keep the dc link high by regeneratively recovering the kinetic energy in the motor load in the event of a main power supply loss.

Parameter Name	No.	Path	Default	Range	Units	Writable
Pwrl Enable	1645	Parameters::Motor Control::Power Loss Ride Thru	FALSE			STOPPED
Enable the Power Loss Ride Through feature.						
Pwrl Trip Threshold	1646	Parameters::Motor Control::Power Loss Ride Thru	52.0	20.0 to 60.0	%	STOPPED
Determines the dc link volts at which the Power Loss Ride Through sequence is triggered. % of the max dc link voltage (drive overvoltage level = 100%)						
Pwrl Control Band	1647	Parameters::Motor Control::Power Loss Ride Thru	2.0	0.0 to 20.0	%	STOPPED
Determines the band while the speed setpoint is ramped down. % of the max dc link voltage (drive overvoltage level = 100%) Once the dclink falls down below Pwrl TripThreshold , the speed septoint is ramped to zero until the dc link rises above Pwrl trip Threshold + Pwrl Control Band . Then the speed septoint is hold, waiting either to continue ramping down if the dc link is still moving down or ramped back to the speed septoint if the supply returns.						
Pwrl Accel Rate	1648	Parameters::Motor Control::Power Loss Ride Thru	100	1 to 500	Hz/s	STOPPED
Rate in Hz/s (electrical frequency/ second) at which the speed septoint is ramped back to the speed demand						

C-150 Parameter Reference

Parameter Name	No.	Path	Default	Range	Units	Writable
Pwrl Decel Rate	1649	Parameters::Motor Control::Power Loss Ride Thru	100	1 to 500	Hz/s	STOPPED
<p>Rate in Hz/s (electrical frequency/ second) at which the speed septoint is ramped to Zero</p> <p>If this value is set too low, then the deceleration will may be not enough high for having regenerative condition to maintain the dc link.</p>						
Pwrl Time Limit	1650	Parameters::Motor Control::Power Loss Ride Thru	30.000	0.000 to 300.000	s	STOPPED
<p>Maximum allowed time in second of the Power Loss Ride Through sequence</p> <p>If this value is reached, the the drive will trip on POWER LOSS STOP.</p>						
Pwrl Active	1651	Parameters::Motor Control::Power Loss Ride Thru				NEVER
<p>This diagnostic is TRUE while the Power Loss Ride Through is active</p>						

Functional Description

When **Pwrl Enable** is set to TRUE, the block controls the behaviour of the drive during a power outage.

This is achieved by ramping the speed setpoint to zero(**Pwrl Decel Rate**).

The dc link fall detection is triggered by **Pwrl Trip Threshold**. **Pwrl Control Band** determines the band of dc link (between by **Pwrl Trip Threshold** and **Pwrl trip Threshold + Pwrl Control Band**) while the speed septoint is ramped down to zero using **Pwrl Decel Rate** to try recovering the kinetic energy.

If during the outage the supply returns, the speed is automatically ramped back (**Pwrl Accel Rate**) to the speed setpoint.

The condition to validate the supply returns is met if the dc link is kept higher than (**Pwrl trip Threshold + Pwrl Control Band**) for more than 500ms. During this time, the speed setpoint is hold.

Pwrl Time Limit determines the maximum time of the Power Loss Ride Through sequence. If this time is exceeded, the drive will trip on POWER LOSS STOP.

During the Power Loss Ride Through sequence, **Pwrl Active** becomes TRUE.

When **Pwrl Enable** is set to FALSE, the drive will trip on UNDERVOLTS if the main supply is removed.

This feature is run at a rate of 1 milli-second.

IMPORTANT: If **DC Link Volts Limit** feature enabled, **Pwrl Accel Rate** and **Pwrl Decel Rate** really applied to the speed setpoint are limited by **Acceleration Time** and **Deceleration Time** of the Ramp.

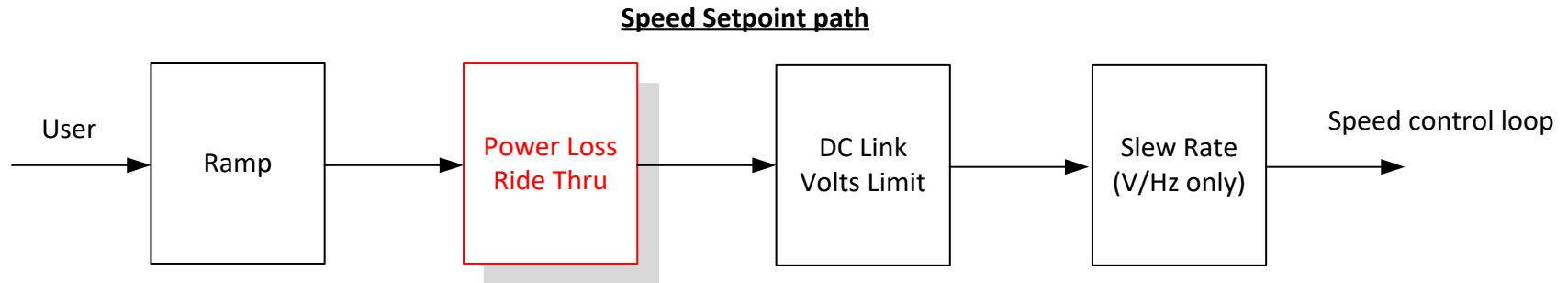

C-152 Parameter Reference

Precision Time Protocol (PTP)

Setup::Communications::PTP

Monitor:: Communications::PTP

Parameters::Base Comms::PTP

Refer to Chapter 8 “Ethernet”.

Preset Speeds

Setup::Application::Preset Speeds
Monitor::Application::Preset Speeds*

This function is available when the **Presets** macro is selected.

The **Presets** function selects 1 of 8 values to be used as a reference.

Parameter Name	No.	Path	Default	Range	Units	Writable
Preset Speed 0 Preset Speed Output when Selected Preset equals 0	1916	Setup::Application::Preset Speeds	0.0	-100.0 to 100.0	%	ALWAYS
Preset Speed 1 Preset Speed Output when Selected Preset equals 1	1917	Setup::Application::Preset Speeds	0.0	-100.0 to 100.0	%	ALWAYS
Preset Speed 2 Preset Speed Output when Selected Preset equals 2	1918	Setup::Application::Preset Speeds	0.0	-100.0 to 100.0	%	ALWAYS
Preset Speed 3 Preset Speed Output when Selected Preset equals 3	1919	Setup::Application::Preset Speeds	0.0	-100.0 to 100.0	%	ALWAYS
Preset Speed 4 Preset Speed Output when Selected Preset equals 4	1920	Setup::Application::Preset Speeds	0.0	-100.0 to 100.0	%	ALWAYS
Preset Speed 5 Preset Speed Output when Selected Preset equals 5	1921	Setup::Application::Preset Speeds	0.0	-100.0 to 100.0	%	ALWAYS
Preset Speed 6 Preset Speed Output when Selected Preset equals 6	1922	Setup::Application::Preset Speeds	0.0	-100.0 to 100.0	%	ALWAYS
Preset Speed 7 Preset Speed Output when Selected Preset equals 7	1923	Setup::Application::Preset Speeds	0.0	-100.0 to 100.0	%	ALWAYS
Selected Preset* Monitor showing selected preset number	1924	Monitor::Application::Preset Speeds		0 to 7		NEVER
Preset Speed Output Monitor showing selected preset value	1925	Monitor::Application::Preset Speeds		-100.0 to 100.0	%	NEVER

Select 0

This is connected to a Digital Input as part of the selected macro. It provides bit 0 of the Selected Preset number.

Select 1

This is connected to a Digital Input as part of the selected macro. It provides bit 1 of the Selected Preset number.

Select 2

This is connected to a Digital Input as part of the selected macro. It provides bit 2 of the Selected Preset number.

C-154 Parameter Reference

Functional Description

Select 2	Select 1	Select 0	Selected Preset
FALSE	FALSE	FALSE	Preset Speed 0
FALSE	FALSE	TRUE	Preset Speed 1
FALSE	TRUE	FALSE	Preset Speed 2
FALSE	TRUE	TRUE	Preset Speed 3
TRUE	FALSE	TRUE	Preset Speed 4
TRUE	TRUE	FALSE	Preset Speed 5
TRUE	FALSE	FALSE	Preset Speed 6
TRUE	FALSE	FALSE	Preset Speed 7

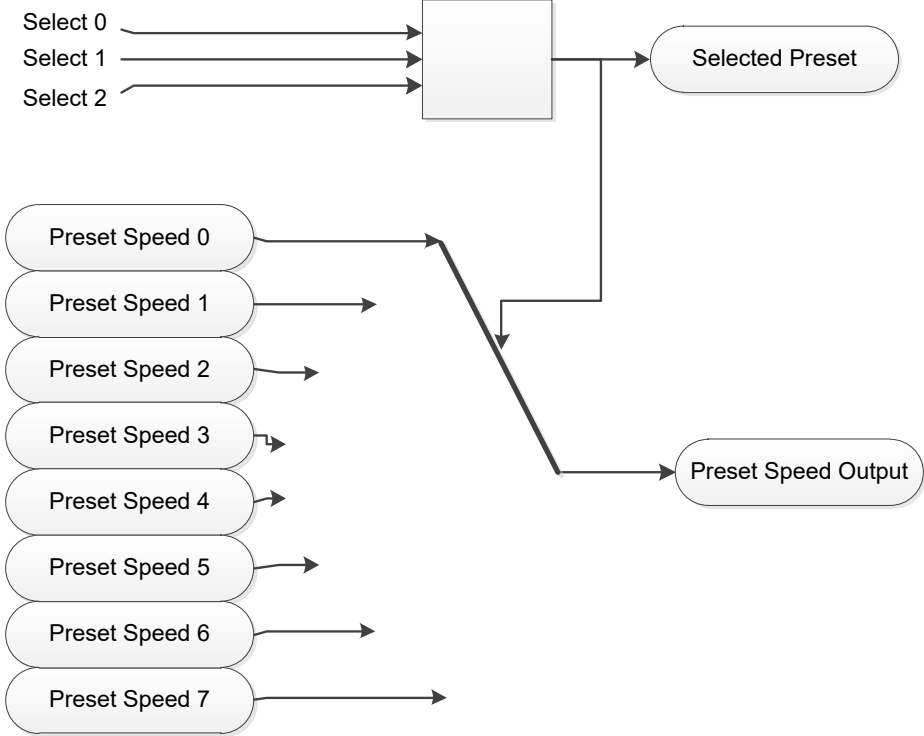

Profibus DP-V1 Option

Monitor::Communications::Option

Setup::Communications::Option

Parameters::Option Comms::Comms

Parameters::Option Comms::Read Process

Parameters::Option Comms::Write Process

Parameters::Option Comms::Event

Parameters::Option Comms::Profibus

[Refer to Profibus DP-V1 Technical Manual HA501837U001](#)

C-156 Parameter Reference

PROFINET IO Option

Monitor::Communications::Option
Setup::Communications::Option
Parameters::Option Comms::Comms
Parameters::Option Comms::Read Process
Parameters::Option Comms::Write Process
Parameters::Option Comms::Event
Parameters::Option Comms::Option Ethernet
Parameters::Option Comms::PROFINET IO

[Refer to Profinet IO Technical Manual HA501838U001](#)

Raise Lower

Setup::Application::Raise Lower
Monitor::Application::Raise Lower*

Appears when the **Raise/Lower** macro is selected.

The **Raise/Lower** function acts as an internal motorised potentiometer (MOP) used as a reference source.

Parameter Name	No.	Path	Default	Range	Units	Writable
RL Ramp Time	1901	Setup::Application::Raise Lower	10.0	0.0 to 600.0	s	ALWAYS
Rate of change of the Output . Defined as the time to change from 0.00% to 100.00% . Note that the raise and lower rates are always the same.						
RL Reset Value	1902	Setup::Application::Raise Lower	0.0	-500.0 to 500.0	%	ALWAYS
The value Output is set to when the Reset Input is TRUE.						
RL Maximum Value	1903	Setup::Application::Raise Lower	100.0	-500.0 to 500.0	%	ALWAYS
The maximum value to which Output will ramp up to.						
RL Minimum Value	1904	Setup::Application::Raise Lower	-100.0	-500.0 to 500.0	%	ALWAYS
The minimum value to which Output will ramp down to.						
Reset Input						
This is connected to a Digital Input as part of the selected Macro. When TRUE forces Output to track Reset Value .						
Raise Input						
This is connected to a Digital Input as part of the selected Macro. When TRUE causes Output to ramp up.						

C-158 Parameter Reference

Parameter Name	No.	Path	Default	Range	Units	Writable
----------------	-----	------	---------	-------	-------	----------

Lower Input

This is connected to a Digital Input as part of the selected Macro. When TRUE causes **Output** to ramp down.

Raise Lower Output	1905	Monitor::Application::Raise Lower	0.0	-500.0 to 500.0		NEVER
---------------------------	------	-----------------------------------	-----	-----------------	--	-------

The ramp output monitor. **Output** is preserved during the power-down of the Drive.

Functional Description

The table below describes how **Output** is controlled by **Raise Input**, **Lower Input** and **Reset Input**.

Reset	Raise Input	Lower Input	Action
TRUE	Any	Any	Output tracks Reset Value
FALSE	TRUE	FALSE	Output ramps up to Maximum Value at Ramp Time
FALSE	FALSE	TRUE	Output ramps down to Minimum Value at Ramp Time
FALSE	FALSE	FALSE	Output not changed. *
FALSE	TRUE	TRUE	Output not changed. *

* If **Output** is greater than **Maximum Value** the **Output** will ramp down to **Maximum Value** at **Ramp Time**. If **Output** is less than **Minimum Value** the **Output** will ramp up to **Minimum Value** at **Ramp Time**.

IMPORTANT: *If **Maximum Value** is less than or equal to **Minimum Value**, then **Output** is set to **Maximum Value**.*

Ramp

Parameters::Motor Control::Ramp

This function forms part of the reference generation. It provides the facility to control the rate at which the Drive will respond to a changing setpoint demand.

Parameter Name	No.	Path	Default	Range	Units	Writable
Seq Stop Method VHz	0484	Setup::Motor Control::Control and Type Parameters::Motor Control::Ramp	1	0:DISABLED VOLTAGE 1:RAMP 2:STOP RAMP 3:DC INJECTION		ALWAYS

Volts/Hz control mode only

Selects stopping mode that the controller will use once the run command has been removed. The choices are:

Enumerated Value : Stopping Mode

Seq Stop Method SVC	1257	Setup::Motor Control::Control and Type Parameters::Motor Control::Ramp	1	0:DISABLED VOLTAGE 1:RAMP 2:STOP RAMP		ALWAYS
----------------------------	------	---	---	---	--	--------

All Control modes except Volts/Hz

Selects stopping mode that the controller will use once the run command has been removed. The choices are:

Enumerated Value : Stopping Mode

When DISABLED VOLTAGE (COAST) is selected the motor will free-wheel. When RAMP is selected the Drive will decelerate using the reference ramp deceleration time, provided it is non-zero. When STOP RAMP is selected the motor will decelerate in **Stop Ramp Time**.

Acceleration Time	0486	Same as PNO 484	10.000	0.000 to 3000.000	s	ALWAYS
--------------------------	------	-----------------	--------	-------------------	---	--------

The time that the Drive will take to ramp the setpoint from 0.00% to 100.00% when **Ramp Type** is LINEAR.

Deceleration Time	0487	Same as PNO 484	10.000	0.000 to 3000.000	s	ALWAYS
--------------------------	------	-----------------	--------	-------------------	---	--------

The time that the Drive will take to ramp the setpoint from 100.00% to 0.00% when **Ramp Type** is LINEAR.

C-160 Parameter Reference

Parameter Name	No.	Path	Default	Range	Units	Writable
Symmetric Mode	0488	Parameters::Motor Control::Ramp	FALSE			ALWAYS
<p>Select whether to use Acceleration Time and Deceleration Time pair of ramp rates, or to use Symmetric Time to define the ramp rate for the Drive.</p>						
Ramp Type	0485	Parameters::Motor Control::Ramp	0	0:LINEAR 1:S RAMP		ALWAYS
<p>Selects the ramp type</p>						
Symmetric Mode	0488	Parameters::Motor Control::Ramp	FALSE			ALWAYS
Symmetric Time	0489	Parameters::Motor Control::Ramp	10.000	0.000 to 3000.000	s	ALWAYS
<p>The time that the Drive will take to ramp from 0.00% to 100.00% and from 100.00% to 0.00% when Symmetric Mode is TRUE.</p>						
Sramp Continuous	0490	Parameters::Motor Control::Ramp	FALSE			ALWAYS
<p>When TRUE, and S ramp is selected in Ramp Type, forces a smooth transition if the speed setpoint is changed when ramping. The curve is controlled by the Sramp Acceleration and Sramp Jerk1 to Sramp Jerk 4 parameters. When FALSE, there is an immediate transition from the old curve to the new curve.</p>						
Sramp Acceleration	0491	Parameters::Motor Control::Ramp	10.0	0.0 to 100.0	%/s ²	ALWAYS
<p>Sets the acceleration rate in units of percent per second², i.e. if the full speed of the machine is 1.25m/s then the acceleration will be: $1.25 \times 75.00\% = 0.9375\text{m/s}^2$</p>						
Sramp Deceleration	0492	Parameters::Motor Control::Ramp	10.0	0.0 to 100.0	%/s ²	ALWAYS
<p>This functions in the same way as Sramp Acceleration above.</p>						

Parameter Reference C-161

Parameter Name	No.	Path	Default	Range	Units	Writable
Sramp Jerk 1	0493	Parameters::Motor Control::Ramp	10.0	0.0 to 100.0	%/s ³	ALWAYS
<p>Rate of change of acceleration for the first segment of the curve in units of percent per second³, i.e. if the full speed of the machine is 1.25m/s then the jerk will be: $1.25 \times 50.00\% = 0.625\text{m/s}^3$</p>						
Sramp Jerk 2	0494	Parameters::Motor Control::Ramp	10.0	0.0 to 100.0	%/s ³	ALWAYS
<p>Rate of change of acceleration in units of percent per second³ for segment 2</p>						
Sramp Jerk 3	0495	Parameters::Motor Control::Ramp	10.0	0.0 to 100.0	%/s ³	ALWAYS
<p>Rate of change of acceleration in units of percent per second³ for segment 3</p>						
Sramp Jerk 4	0496	Parameters::Motor Control::Ramp	10.0	0.0 to 100.0	%/s ³	ALWAYS
<p>Rate of change of acceleration in units of percent per second³ for segment 4</p>						
Ramp Hold	0497	Parameters::Motor Control::Ramp	FALSE			ALWAYS
<p>When TRUE the output of the ramp is held at its last value</p>						
Ramping Active	0498	Parameters::Motor Control::Ramp				NEVER
<p>Set TRUE when ramping.</p>						
Ramp Spd Setpoint Input	0499	Parameters::Motor Control::Ramp	x.x	-200.0 to 200.0	%	NEVER
<p>Input speed setpoint to the ramp</p>						

C-162 Parameter Reference

Parameter Name	No.	Path	Default	Range	Units	Writable
Ramp Speed Output	0500	Parameters::Motor Control::Ramp	x.x	-200.0 to 200.0	%	NEVER
Output speed						
Jog Setpoint	0501	Parameters::Motor Control::Ramp	10.0	0.0 to 100.0	%	ALWAYS
The setpoint is the target reference that the Drive will ramp to						
Jog Acceleration Time	0502	Parameters::Motor Control::Ramp	1.000	0.000 to 3000.000	s	ALWAYS
The time that the Drive will take to ramp the jog setpoint from 0.00% to 100.00%.						
Jog Deceleration Time	0503	Parameters::Motor Control::Ramp	1.000	0.000 to 3000.000	s	ALWAYS
The time that the Drive will take to ramp the jog setpoint from 100.00% to 0.00%.						
Stop Ramp Time	0504	Same as PNO 484	10.000	0.000 to 600.000	s	ALWAYS
Rate at which the demand is ramped to zero after the ramp has been quenched						
Zero Speed Threshold	0505	Parameters::Motor Control::Ramp	0.1	0.0 to 100.0	%	ALWAYS
Hold for zero speed detection used by stop sequences						
Zero Speed Stop Delay	0506	Parameters::Motor Control::Ramp	0.500	0.000 to 30.000	s	ALWAYS
Sets the time at which the Drive holds zero speed before quenching after a normal stop or a jog stop. This may be particularly useful if a mechanical brake requires time to operate at zero speed, or for jogging a machine to position						

Parameter Reference C-163

Parameter Name	No.	Path	Default	Range	Units	Writable
Quickstop Time Limit	0507	Parameters::Motor Control::Ramp	30.000	0.000 to 3000.000	s	ALWAYS
Maximum time that the Drive will try to Quickstop, before quenching						
Quickstop Ramp Time	0508	Parameters::Motor Control::Ramp	0.100	0.000 to 600.000	s	ALWAYS
Rate at which the Speed Demand is ramped to zero when Quickstop is active						
Final Stop Rate	0509	Parameters::Motor Control::Ramp	1200	1 to 4800	Hz/s	ALWAYS
Rate at which any internally generated setpoint trims are removed. For example, the trim due to the slip compensation in Volts/Hz control mode.						

C-164 Parameter Reference

Functional Description

The s-ramp output takes the form shown below.

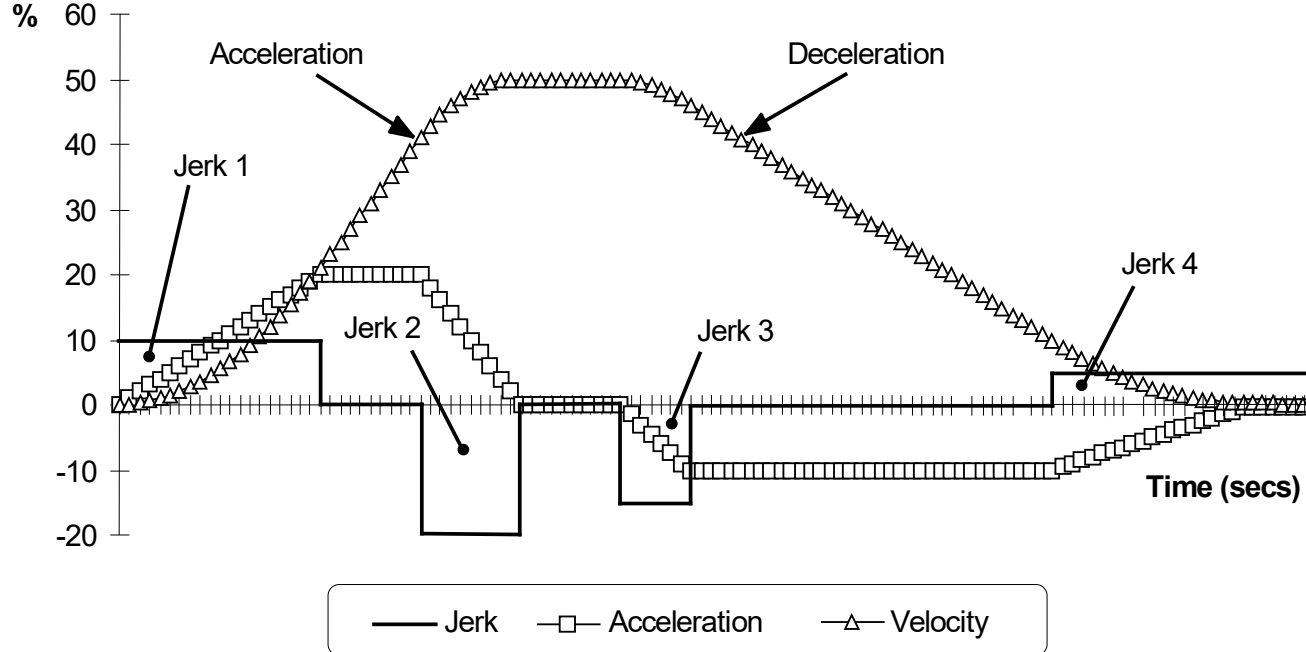

Real Time Clock

Parameters::Device Manager::Real Time Clock

Parameter Name	No.	Path	Default	Range	Units	Writable
Time and Date	1186	Parameters::Device Manager::Real Time Clock	1970/01/01	1970/01/01 to 2038/01/19		ALWAYS
Time and Date in the format yyyy/mm/dd hh:mm:ss						
Time Zone Offset	1228	Parameters::Device Manager::Real Time Clock	0.00	-14.00 to 14.00		ALWAYS
A value in hours that defines the difference between Coordinated Universal Time, (UTC), and local time. UTC is equivalent to Greenwich Mean Time, (GMT). This value is required when the time is to be set from a network source using the SNTP client.						
DST Active	1225	Parameters::Device Manager::Real Time Clock	FALSE			ALWAYS
When TRUE, one hour is added to the internal time before being presented as the value in "Time and Date".						

Functional Description

IO Option Fitted with Real Time Clock

When an IO Option is fitted, (part number 7004-01-00 or 7004-02-00), "Time and Date" reports the time from the associated Real Time Clock hardware. On receiving an IO Option from the factory the time is not set and the value will be fixed at 1970/01/01 00:00:00. To set the correct time write to parameter 1186, or enable the SNTP client if an NTP master is available. Once set the RTC hardware on the IO option will maintain the time even when power to the drive is removed.

SNTP Client

When the SNTP client is enabled, "Time and Date" is updated from the NTP master, adjusted for Time Zone and DST.

SNTP Server

When the SNTP server is enabled, the value of "Time and Date" is adjusted for Time Zone and DST then transmitted to any requesting clients.

No IO Option

When no IO Option is fitted "Time and Date" may be used as the destination of a broadcast time from a communications master.

C-166 Parameter Reference

Resolver

Setup::Inputs and Outputs::Option

Parameters::Option IO::Resolver

Parameter Name	No.	Path	Default	Range	Units	Writable
Resolver Voltage	1790	Setup::Inputs and Outputs::Option Parameters::Option IO::Resolver	4	0:0V 1:4V 2:5V 3:6V 4:7V 5:8V 6:9V 7:10V 8:11V 9:12V		STOPPED

The r.m.s. amplitude of the sinusoidal excitation voltage output.
This is set to the resolver's requirement.
Setting 0V will disable the excitation output.

Resolver Frequency	1791	Same as PNO 1790	8.0	2.0 to 20.0	kHz	STOPPED
---------------------------	------	------------------	-----	-------------	-----	---------

The frequency of the sinusoidal excitation voltage output.
This is set to the resolver's requirement.

Resolver Ratio	1792	Same as PNO 1790	0.50	0.15 to 3.00		STOPPED
-----------------------	------	------------------	------	--------------	--	---------

The ratio of the amplitudes of the sine / cosine feedbacks to the excitation voltage output.
This is set to the resolver's characteristic.

Resolver Max Speed	1825	Setup::Inputs and Outputs::Option Parameters::Option IO::Resolver	20000	0 to 120000	RPM	STOPPED
---------------------------	------	---	-------	-------------	-----	---------

The maximum operating resolver shaft speed required.
This is set to the application requirements, which must be no greater than the resolver rating.
If the resolver is not the active feedback, this is used to auto-select the best possible speed / position resolution.

Parameter Reference C-167

Parameter Name	No.	Path	Default	Range	Units	Writable
Resolver Poles	1793	Same as PNO 1790	2,	2 to 100		STOPPED
<p>The number of poles in the resolver. This is set to the resolver's characteristic A 2-pole resolver has one sine / cosine amplitude cycle for each mechanical rotation of the shaft.</p>						
Resolver Speed Hz	1822	Parameters::Option IO::Resolver	x.x		Hz	NEVER
<p>The mechanical gearing of the resolver, reflecting resolver shaft turns per resolver coil turn. This is set to the resolver's characteristic. For example, a multi-turn 2-pole resolver, that requires 10 resolver shaft rotations for each sine / cosine amplitude cycle, would use value 10.0.</p>						
Resolver Invert	1810	Same as PNO 1790	FALSE			STOPPED
<p>Used to set the direction of rotation which results in the position increasing positively, and the speed reporting as positive.</p>						
Resolver Position	1824	Same as PNO 1811				NEVER
<p>(ENGINEER view level only.) Actual resolver coil position, expressed as a count value, where one complete amplitude cycle is 65536 counts.</p>						
Resolver Turns	1811	Monitor::Inputs and Outputs Parameters::Option IO::Resolver				NEVER
<p>The integer number of completed resolver shaft mechanical turns.</p>						
Resolver Fraction Turns	1812	Same as PNO 1811				NEVER
<p>The fractional part of the number of resolver shaft mechanical turns.</p>						
Resolver Speed Filter	1815	Same as PNO 1790	1000	10 to 10000	%	ALWAYS
<p>The corner frequency of the speed-tracking, single-order filter applied to the raw resolver speed, before it is reported in the Resolver Speed parameters or used as speed feedback. Expressed in terms of the ratio of filter corner frequency to raw resolver cycle frequency. Used to remove speed ripple caused by the resolver measurement, particularly when the option is used as a reference speed input.</p>						

C-168 Parameter Reference

Parameter Name	No.	Path	Default	Range	Units	Writable
Resolver Min Filter	1851	Same as PNO 1825	100	10 to 1000	Hz	ALWAYS
Limit applied as the minimum corner frequency of the speed-tracking, single-order filter applied to the raw resolver speed. Used to prevent the speed-tracking filter from causing control instabilities at low speed.						
Resolver Actual Filter	1826	Parameters::Option IO::Resolver	x.	20 to 8000	Hz	NEVER
The actual corner frequency being used for the speed-tracking, single-order filter applied to the raw resolver speed. The actual filter corner frequency is limited to 8000Hz maximum.						
Resolver Speed RPM	1813	Parameters::Option IO::Resolver	x.x		RPM	NEVER
Resolver mechanical speed diagnostic / output.						
Resolver Speed %	1814	Same as PNO 1811	x.x		%	NEVER
Resolver mechanical speed diagnostic / output.						
Resolver Speed Hz	1821	Parameters::Option IO::Resolver	x.x		Hz	NEVER
Resolver mechanical speed diagnostic / output.						
Resolver Speed Ripple	1823	Parameters::Option IO::Resolver	x.xx	0.00 to 1000.00	%	NEVER
The peak-to-peak ripple in resolver speed samples. Used to assist the trimming process which gain matches the sine to cosine inputs. Calculated from max. speed – min. speed over last 128 samples on a 1ms sampling interval. % is scaled by 464 100% Speed in RPM						
Resolver Resolution	1816	Same as PNO 1790	0	0:AUTO 1:12 BITS 2:14 BITS 3:16 BITS		STOPPED
The target resolution setting for the speed / position feedback. See 'Specifications' for limitations, prior to changing this parameter. The 'AUTO' setting is used to automatically select the best, allowable resolution, given other parameter settings. The resolution setting affects the dynamic performance of the feedback. In 'AUTO' mode, the actual resolution in use may be different from the target resolution, depending on other parameter settings. Only change this parameter when motor is stopped / torque is off.						

Parameter Reference C-169

Parameter Name	No.	Path	Default	Range	Units	Writable
Resolver Active Resol	1827	Parameters::Option IO::Resolver		Same as PNO 1816		NEVER
<p>The actual resolution setting for the speed / position feedback. The resolution setting affects the dynamic performance of the feedback. In 'AUTO' mode, the actual resolution in use may be different from the target resolution, depending on other parameter settings :</p> <p>12 BITS only use for excitation between 6kHz and 20kHz.</p> <p>14 BITS only use for excitation between 3kHz and 12kHz, and <i>max. speed parameter</i> set < 30000rpm. Max speed* set up < 30000RPM</p> <p>16 BITS only use for excitation between 2kHz and 10kHz, and <i>max. speed parameter</i> set < 7500rpm. Max speed* set up < 7500RPM</p> <p>(*) : if the option is the active feedback, then Max speed = 464 100% Speed in RPM If the option is not the active feedback, then Max speed = 1825 Resolver Max Speed</p>						
Resolver State	1817	Parameters::Option IO::Resolver		0:POWER_ON 1:RESET 2:ACTIVE 3:TRIPPED 4:RESTART		NEVER
<p>The state of the Resolver Feedback Option. ACTIVE = Operating TRIPPED = Not-Operating due to a detected fault (see parameter Resolver Trip Type). ¹A fault detected when the option is being used as the active feedback will cause a drive trip, stopping the motor.</p>						
Resolver Turns Reset	1818	Parameters::Option IO::Resolver	FALSE			ALWAYS
<p>Used to reset both the Resolver Turns and Fraction Turns to zero, and Resolver Trip Type. The turns count parameters are held at zero whilst this parameter is held TRUE. The state of this parameter does not affect the operation of the resolver as a speed / position feedback, it only affects the turn count diagnostics.</p>						
Resolver Reset Power On	1819	Parameters::Option IO::Resolver	FALSE			STOPPED
<p>When TRUE the Resolver Turns and Resolver Fraction Turns parameters are reset to zero on drive power-on. When FALSE the Resolver Turns and Resolver Fraction Turns parameters will persist through power cycling. The absolute shaft position will be retained, provided that no more than 180° of resolver coil rotation has occurred during the power-off state.</p>						

C-170 Parameter Reference

Parameter Name	No.	Path	Default	Range	Units	Writable
Resolver Trip Type	1820	Parameters::Option IO::Resolver		0:NONE 1:PARITY 2:PHASE ERROR 3:MAX VELOCITY 4:TRACKING ERROR 5:SIN COS MISMATCH 6:SIN COS OVERRANGE 7:SIN COS BELOW LOS 8:SIN COS CLIPPED		NEVER

Diagnostic that indicates the current (or most recent) trip type on the resolver option.

May be reset to NONE by using parameter 'Resolver Turns Reset'.

Value meanings:

PARITY : Parity error in the configuration register of the option. Contact Parker for assistance.

PHASE ERROR : Phase lag from excitation output to sin / cos inputs exceeds operating limit. Check resolver specification.

MAX VELOCITY : Velocity exceeds maximum tracking rate. Select resolver with built-in gearing to reduce resolver velocity.

TRACKING ERROR : Position tracking phase locked loop has exceeded its maximum error limit. Use a lower acceleration rate or select a lower target resolution.

SIN COS MISMATCH : The amplitudes of the sine and cosine inputs differ excessively. Check input connections, and gain matching potentiometer setting.

SIN COS OVERRANGE : One or both of the sine / cosine input signals is overrange. Check that the Resolver Ratio parameter is set correctly, and that the input signals do not exceed 12.5Vrms.

SIN COS BELOW LOS : One or both of the sine / cosine input signals is underrange. Check that the Resolver Ratio parameter is set correctly, and that the input signals are at least 1.6Vrms.

SIN COS CLIPPED : One or both of the sine / cosine input signals is overrange and being clipped. Check that the Resolver Ratio parameter is set correctly, and that the input signals do not exceed 12.5Vrms.

Runtime Statistics

Parameters::Device Manager::Runtime Statistics

Parameter Name	No.	Path	Default	Range	Units	Writable
Control Board Up Time	1139	Parameters::Device Manager::Runtime Statistics		0 to Max	s	NEVER
The total time in seconds for which the control module has been powered, either by 24v or from the 3-phase supply. Set to zero during manufacture.						
Time Since Power-On	1733	Parameters::Device Manager::Runtime Statistics		0.000 to Max	s	NEVER
The time in seconds since power was applied to the control module, either by 24v or from the 3-phase supply.						
HV SMPS Up Time	1252	Parameters::Device Manager::Runtime Statistics		0 to Max	s	NEVER
The time in seconds for which the drive has been powered from the 3-phase supply.						
HV Power On Count	1406	Parameters::Device Manager::Runtime Statistics		0 to 65535		NEVER
The number of times that the drive has been powered up from the 3-phase supply						
Motor Run Time	1407	Parameters::Device Manager::Runtime Statistics		0 to Max	s	NEVER
The time in seconds for which the drive has been controlling a motor						
Motor Start Count	1732	Parameters::Device Manager::Runtime Statistics		0 to Max		NEVER
The total number of motor starts, (from when the control card was manufactured).						

C-172 Parameter Reference

Parameter Name	No.	Path	Default	Range	Units	Writable
Time Since Power-On	1733	Parameters::Device Manager::Runtime Statistics		0.000 to Max	s	NEVER

The time in seconds since power was applied to the control module, (either 24v or 3-phase power).

Functional Description

The Runtime Statistics group of parameters indicate the working age of the drive. The Control Board Up Time value is used as a reference when recording the time at which a trip occurs. Similarly, the HV SMPS Up Time is used as a reference when recording the time at which a disabled trip event occurs when the drive is operating in Fire Mode, (see *Chapter 13: Fire Mode*, and HA502134U002 “Fan Control Application” manual).

SB Digital IO

Parameters::System Board:: SB Digital IO

Parameter Name	No.	Path	Default	Range	Units	Writable
SB Digital Input 1	1759	Monitor::Inputs and Outputs Parameters::System Board::SB Digital IO				NEVER
Digital input from X30.1, TRUE for a high voltage and FALSE for a low voltage.						
SB Digital Input 2	1722	Monitor::Inputs and Outputs Parameters::System Board::SB Digital IO				NEVER
Digital input from X30.2, TRUE for a high voltage and FALSE for a low voltage.						
SB Digital Input 3	1723	Same as PNO 1722				NEVER
Digital input from X30.3, TRUE for a high voltage and FALSE for a low voltage.						
SB Digital Input 4	1365	Monitor::Inputs and Outputs Parameters::System Board::SB Digital IO				NEVER
Digital input from X34.5, TRUE for a high voltage and FALSE for a low voltage. Shared with SB Digital Output 1						
SB Digital Input 5	1366	Same as PNO 1365				NEVER
Digital input from X34.6, TRUE for a high voltage and FALSE for a low voltage. Shared with SB Digital Output 2						
SB Digital Input 6	1367	Same as PNO 1365				NEVER
Digital input from X34.7, TRUE for a high voltage and FALSE for a low voltage. Shared with SB Digital Output 3						

C-174 Parameter Reference

Parameter Name	No.	Path	Default	Range	Units	Writable
SB Digital In 1 Invert	1332	Parameters::System Board::SB Digital IO	FALSE			ALWAYS
Inverts the value of SB Digital Input 1						
SB Digital In 2 Invert	1333	Parameters::System Board::SB Digital IO	FALSE			ALWAYS
Inverts the value of SB Digital Input 2						
SB Digital In 3 Invert	1334	Parameters::System Board::SB Digital IO	FALSE			ALWAYS
Inverts the value of SB Digital Input 3						
SB Digital In 4 Invert	1368	Parameters::System Board::SB Digital IO	FALSE			ALWAYS
Inverts the value of SB Digital Input 4						
SB Digital In 5 Invert	1369	Parameters::System Board::SB Digital IO	FALSE			ALWAYS
Inverts the value of SB Digital Input 5						
SB Digital In 6 Invert	1370	Parameters::System Board::SB Digital IO	FALSE			ALWAYS
Inverts the value of SB Digital Input 6						
SB Digital Output 1	1371	Parameters::System Board::SB Digital IO	FALSE			ALWAYS
The value to output on X34.5. TRUE for a high voltage, FALSE for zero volts. Shares the terminal with SB Digital Input 4.						

Parameter Reference C-175

Parameter Name	No.	Path	Default	Range	Units	Writable
SB Digital Output 2	1372	Parameters::System Board::SB Digital IO	FALSE			ALWAYS
The value to output on X34.6. TRUE for a high voltage, FALSE for zero volts. Shares the terminal with SB Digital Input 5.						
SB Digital Output 3	1373	Parameters::System Board::SB Digital IO	FALSE			ALWAYS
The value to output on X34.7. TRUE for a high voltage, FALSE for zero volts. Shares the terminal with SB Digital Input 6.						
SB Dig Out 1 Invert	1374	Parameters::System Board::SB Digital IO	FALSE			ALWAYS
Inverts the value to be used for SB Digital Output 1						
SB Dig Out 2 Invert	1375	Parameters::System Board::SB Digital IO	FALSE			ALWAYS
Inverts the value to be used for SB Digital Output 2						
SB Dig Out 3 Invert	1376	Parameters::System Board::SB Digital IO	FALSE			ALWAYS
Inverts the value to be used for SB Digital Output 2						

Functional Description

These parameters are used to configure the system board outputs and to monitor the system board inputs.

C-176 Parameter Reference

SB Encoder

Setup:: Inputs and Outputs::SB Encoder

Monitor::SB Encoder

Parameters::System Board::SB Encoder

The AC30A Encoder block provides the means for selecting the type of Encoder connected on the AC30A system board type

Parameter Name	No.	Path	Default	Range	Units	Writable
Encoder Supply	1874	Setup::Inputs and Outputs::SB Encoder Parameters::System Board::SB Encoder	0	0:5V 1:10V		STOPPED
Allows the user to select the correct supply voltage for the pulse encoder.						
Encoder Type	1875	Same as PNO 1874	0	0:SIN COS 1: ENDAT 2.1 ST 2: ENDAT 2.1 MT		STOPPED
Allows the user to select the encoder type connected. SINCOS type is incremental encoder type. Associated to a PMAC motor, setting up the position offset needs to be done at each drive power on or after a trip related to the encoder. ENDAT 2.1 ST is endat single turn encoder type. ENDAT2.1 MT is endat mutli turn encoder type.						
Encoder Lines	1876	Same as PNO 1874	512	1 to 1048576		STOPPED
Allows the user to select the correct number of lines per one encoder revolution.						
Encoder Invert	1877	Same as PNO 1874	FALSE			STOPPED
Reverses the encoder direction if set to TRUE. The encoder direction needs to be correct if encoder feedback is used to control the motor in vector mode. The autotune identifies whether the parameter is in the correct state required to control the motor, and changes it if necessary (for Induction motor only). It is possible to do this manually, by attempting to run the motor, and changing the parameter if necessary until the motor is controlled correctly.						
Encoder Speed	1892	Same as PNO 1878	x.		RPM	NEVER
The encoder mechanical speed measured by the encoder, in revolutions per minute.						

Parameter Reference C-177

Parameter Name	No.	Path	Default	Range	Units	Writable
Encoder Speed Percent	1893	Parameters::System Board::SB Encoder	x.xx		%	NEVER
<p>The encoder mechanical speed measured by the encoder, in %. 100% refers to 100% Speed in RPM (0464)</p>						
Encoder Count	1878	Monitor::System Board::SB Encoder Parameters::System Board::SB Encoder				NEVER
<p>The encoder count will increment and decrement with the encoder lines multiplied by 4, up to encoder lines by 4 or down to zero. It provides the line count on one mechanical encoder revolution and is the absolute position in case of Absolute encoder.</p>						
Encoder Rev Count	1879	Same as PNO 1878				NEVER
<p>The encoder count is a 32 bit counter which will increment and decrement with the encoder rev. When using a SinCos, the count may vary between 0 to 4095.</p>						
Encoder Position	1310	Parameters::System Board::SB Encoder	x.xx	-180.00 to 180.00	deg	NEVER
<p>Mechanical encoder position in degrees on one mechanical encoder turn</p>						
Enc To Mot Shaft Ratio	1231	Setup::Inputs and Outputs::SB Encoder Parameters::System Board::SB Encoder	1	1 to 50		STOPPED
<p>Ratio between encoder turn and shaft motor turn in case of pulley belt system. Represents the number of encoder turn for a shaft motor turn. This value must be compatible with the number of motor poles : dividing the number of motor poles by this number should give an integer value.</p>						
Motor Count	1898	Parameters::System Board::SB Encoder				NEVER
<p>32 bit counter reflecting the motor equivalent encoder lines count times 4 and times the encoder to motor shaft ratio. Reset when Reset Motor Count is active.</p>						

C-178 Parameter Reference

Parameter Name	No.	Path	Default	Range	Units	Writable
Motor Position	1230	Parameters::System Board::SB Encoder	x.xx	-180.00 to 180.00	deg	NEVER
Motor position in degrees on one motor mechanical turn						
Mechanical Offset	1229	Parameters::System Board::SB Encoder	x			NEVER
Represents the offset in count between the Motor Count and the Total Encoder Count (Encoder Rev Count * Encoder Lines * 4 + Encoder Count)						
Motor Count Reset	1894	Same as PNO 1874	FALSE			ALWAYS
Resets the Motor Count parameter at the actual motor mechanical position. The reset action may cause a value of 0,1,2 or 3. This is related to the actual sin and cos informations. The count reset only resets the count line, not the sub count line.						
Encoder Status	1232	Parameters::System Board::SB Encoder		0:OK 1:SIN COS ISSUE 2:OK WITH COMMS WARNING 3:COMMS ERROR 4:CALIB IN PROGRESS 5:CALIB ERROR 6:NOT DETECTED		NEVER
Status of the encoder connected.						

SB Encoder Slot 1**Parameters::System Board::Encoder Slot 1**

This feature allows you to setup and monitor the operation of the encoder attached to slot 1 of the system board.

Parameter Name	No.	Path	Default	Range	Units	Writable
Encoder Supply	1663	Setup::Inputs and Outputs::SB Encoder Slot1 Parameters::System Board::SB Encoder Slot 1	0	0:5 V 1:12 V 2:15 V 3:20 V		STOPPED
Configures the encoder supply for both Encoder 1 <i>and Encoder 2</i>						
Encoder Lines	1664	Same as PNO 1663	2048	1 to 100000		STOPPED
The number of lines per encoder revolution						
Encoder Invert	1665	Same as PNO 1663	FALSE			STOPPED
Reverses the encoder direction if TRUE.						
Encoder Type	1666	Same as PNO 1663	0	0:QUADRATURE 1:CLOCK/DIRECTION		
Normally the encoder will be quadrature. Exceptionally, eg if a proximity sensor or other pulse train is used, it needs to be clock / direction.						
High Input Threshold	1667	Same as PNO 1663	FALSE			STOPPED
Changes the threshold level for the encoder pulses between 1.8 V and 6.5 V typical. For encoders powered from 5 V the low threshold should be used. For other supply voltages the high threshold will provide greater noise immunity.						
Encoder Speed	1668	Monitor::System Board::SB Encoder Slot 1 Parameters::System Board::SB Encoder Slot 1			RPM	NEVER
The speed measured by the encoder, in revolutions per minute.						

C-180 Parameter Reference

Parameter Name	No.	Path	Default	Range	Units	Writable
Encoder Speed Percent	1855	Parameters::Option IO::Encoder			%	NEVER
The speed measured by the encoder, as a percentage of 100% Speed.						
Encoder Count Reset	1669	Same as PNO 1663	FALSE			ALWAYS
Resets the encoder count.						
Encoder Count	1670	Same as PNO 1668		Min to Max		NEVER
The encoder count is a 32 bit count which will increment and decrement with the encoder pulses, up to (or down to) 2^{31} .						

SB Encoder Slot 2

Parameters::System Board::Encoder Slot 2

This feature allows you to setup and monitor the operation of the encoder attached to slot 2 of the system board.

Parameter Name	No.	Path	Default	Range	Units	Writable
Encoder Lines	1671	Setup::Inputs and Outputs::SB Encoder Slot2 Parameters::System Board::SB Encoder Slot 2	2048	1 to 100000		STOPPED
The number of lines per encoder revolution						
Encoder Invert	1672	Same as PNO 1671	FALSE			STOPPED
Reverses the encoder direction if TRUE.						
Encoder Type	1673	Same as PNO 1671	0	0:QUADRATURE 1:CLOCK/DIRECTION		STOPPED
Normally the encoder will be quadrature. Exceptionally, eg if a proximity sensor or other pulse train is used, it needs to be clock / direction.						
High Input Threshold	1674	Same as PNO 1671	FALSE			STOPPED
Changes the threshold level for the encoder pulses between 1.8 V and 6.5 V typical. For encoders powered from 5 V the low threshold should be used. For other supply voltages the high threshold will provide greater noise immunity.						
Encoder Speed	1675	Monitor::System Board::SB Encoder Slot 2 Parameters::System Board::SB Encoder Slot 2			RPM	NEVER
The speed measured by the encoder, in revolutions per minute.						
Encoder Count Reset	1676	Same as PNO 1671	FALSE			ALWAYS
Resets the encoder count.						
Encoder Count	1677	Same as PNO 1675		Min to Max		NEVER
The encoder count is a 32 bit count which will increment and decrement with the encoder pulses, up to (or down to) 2 ³¹ .						

C-182 Parameter Reference

SB Retransmit

Parameters::System Board::System Board IO

Parameter Name	No.	Path	Default	Range	Units	Writable
Output Enable	1678	Setup::Inputs and Outputs::System Board Option Parameters::System Board::SB Retransmit	FALSE			ALWAYS
Turns on the system board A, B and Z outputs.						
Output Source	1679	Same as PNO 1678	0	0:SYSTEM BOARD SLOT 1 1:SYSTEM BOARD SLOT 2 2:SYNTHETIC ENCDR 3:DIGITAL OUTPUTS 4:MAIN SPD FEEDBACK		STOPPED
Selects the source of the retransmit output. i.e. Slot 1, Slot 2, synthetic encoder, or the Encoder fitted into the main speed feedback. If SYSTEM BOARD SLOT 1 or SYSTEM BOARD SLOT 2 is selected, the output number of lines is a copy of the source number of lines. If MAIN SPD FEEDBACK is selected, then the output number of lines can be set up independantly of the source number of lines (limited to a max value of 16384)						
Output Voltage	1680	Same as PNO 1678	0	0:5 V 1:12 V 2:15 V 3:20 V		ALWAYS
Sets the voltage output of the system board encoder retransmit.						
Synth Encoder Lines	1696	Same as PNO 1678	2048	1 to 15000000		ALWAYS
Number of lines per revolution to be simulated by the synthetic encoder function. This affects the Z output pulse.						
Synth Encoder Speed	1698	Same as PNO 1678	0	0 to 15000000	RPM	ALWAYS
Simulated speed to output when the synthetic encoder mode is selected.						

Parameter Name	No.	Path	Default	Range	Units	Writable
Synth Encoder Invert	1702	Same as PNO 1678	FALSE			ALWAYS
Sets the direction of the synthetic encoder rotation.						
Z Pulse	1870	Setup::Inputs and Outputs::System Board Option Parameters::System Board::SB Retransmit	FALSE			ALWAYS
Only available is Output Source is set to SYNTHETIC ENCDR or MAIN SPD FEEDBACK Allows to set up the Z pulse signals. It occurs on the falling edge (TRUE to FALSE) of this parameter.						
Z Pulse Init Done	1872	Setup::Inputs and Outputs::System Board Option Parameters::System Board::SB Retransmit	FALSE			ALWAYS
Only available is Output Source is set to MAIN SPD FEEDBACK TRUE if initialisation of Z pulse position has been run successfully. FALSE during initialisation phase : at start up or during selection of a new Z pulse position.						
Output A	1756	Setup::Inputs and Outputs::System Board Option Parameters::System Board::SB Retransmit	FALSE			ALWAYS
Value presented on terminal X33.1 with respect to X33.2 when "1679 Output Source" is set to DIGITAL OUTPUTS						
Output B	1757	Same as PNO 1756	FALSE			ALWAYS
Value presented on terminal X33.3 with respect to X33.4 when "1679 Output Source" is set to DIGITAL OUTPUTS						
Output Z	1758	Same as PNO 1756	FALSE			ALWAYS
Value presented on terminal X33.5 with respect to X33.6 when "1679 Output Source" is set to DIGITAL OUTPUTS						

C-184 Parameter Reference

Parameter Name	No.	Path	Default	Range	Units	Writable
Output A Invert	1291	Parameters::System Board::SB Retransmit	FALSE			ALWAYS
Inverts the value from Output A when "1679 Output Source" is set to DIGITAL OUTPUTS						
Output B Invert	1292	Parameters::System Board::SB Retransmit	FALSE			ALWAYS
Inverts the value from Output B when "1679 Output Source" is set to DIGITAL OUTPUTS						
Output Z Invert	1293	Parameters::System Board::SB Retransmit	FALSE			ALWAYS
Inverts the value from Output Z when "1679 Output Source" is set to DIGITAL OUTPUTS						
Output Z Invert	1870	Parameters::System Board::SB Retransmit	FALSE			ALWAYS
<p>TRUE to FALSE to validate the actual position of the Synthetic encoder as the Zero position. Synthetic encoder output will generate a Zpulse every turn. Synthetic encoder position is reset to Zero. The position is validated on a TRUE to FALSE change of this parameter.</p> <p>If MAIN SPD FEEDBACK, the Z pulse position is kept in memory during power cycle.</p>						
Output Z Invert	1871	Parameters::System Board::SB Retransmit	FALSE			ALWAYS
<p>Synthetic encoder count. Values are limited to +/- 1024 turns.</p> <p>Only available if the Output Source of the retransmit Output is set to MAIN SPD FEEDBACK.</p> <p>Valus is reset to Zero on a TRUE to FALSE transition of the Z pulse Input.</p>						
Output Z Invert	1872	Parameters::System Board::SB Retransmit	FALSE			ALWAYS
TRUE if initialisation of Z pulse position has been run successfully. FALSE during initialisation phase : at start up or after selection of a new Z pulse position.						

Functional Description

These parameters are used to configure the system board retransmit outputs.

Scale Setpoint

Parameters::Motor Control::Scale Setpoint

This function defines 100% speed in RPM.

Parameter Name	No.	Path	Default	Range	Units	Writable
100% Speed in RPM	464	Setup::Motor Control::Control and Type Parameters::Motor Control::Scale Setpoint	1500.0	0.0 to 100000.0	RPM	ALWAYS
Speed in RPM equivalent to a setpoint of 100%						
Speed Demand RPM	465	Parameters::Motor Control::Scale Setpoint	x.x		RPM	NEVER
Setpoint scaled to RPM						
Speed Demand Hz	466	Parameters::Motor Control::Scale Setpoint	x.x		Hz	NEVER
Setpoint scaled to electrical Hz.						

Functional Description

The Drive is commanded to run the motor at a certain speed, which is derived from various sources, such as comms, analog inputs, commands from the keypad, etc. All these speed commands are expressed as a percentage. The percentage is referenced to parameter PNO 0464. So, for example, if PNO 0464 is set to 3000 rpm, and the user commands 100% speed, then the motor should turn at 3000rpm.

The user should be aware of what PNO 0464 means for different control options:

- For vector control (both for PMAC and IM) for 100% demand the motor will provide the actual shaft speed of the value that is set in PNO 0464.
- For V/Hz control (IM only) for 100% demand the actual shaft speed will be the value set in this parameter less than the slip of the motor. So, in order to achieve rated speed at rated torque in V/Hz mode, the user should set PNO 0464 to an RPM value that corresponds to the base frequency of the motor with the number of pole pairs taken into account, or in other words, '100% Speed in RPM' should be set to synchronous speed. *(For example, a 50Hz, 4 pole induction motor, with rated speed of 1450RPM, should have its '100% Speed in RPM' value set to 1500. This will ensure that in V/Hz mode when the motor is loaded with rated load the actual speed of the shaft will be 1450 RPM!)*

This parameter also represents the maximum speed available, since (apart from a small allowance for process trims) the speed commands are not allowed to exceed 100%.

C-186 Parameter Reference

SD Card

Parameters::Device Manager::SD Card

Details of the SD Card fitted in the Drive.

Parameter Name	No.	Path	Default	Range	Units	Writable
Card State	1033	Parameters::Device Manager::SD Card		0:NO CARD 1:INITIALISING 2:READY 3:CARD FAULT		NEVER
The state of the SD Card will either be:						
0: NO CARD no card detected in slot						
1: INITIALISING a card has been detected but is still preparing for use						
2: READY the card inserted can be used						
3: CARD FAULT the card inserted is faulty and cannot be used. Check "Extended Support" below.						
Card Name	1034	Parameters::Device Manager::SD Card				NEVER
The Volume Label read from the card. This is normally entered when formatting the card. It may be left blank.						
Firmware	1038	Parameters::Device Manager::SD Card				NEVER
TRUE indicates that the firmware upgrade file (firmware.30x) is present on the inserted SD Card.						
Application Archive	1039	Parameters::Device Manager::SD Card				NEVER
TRUE indicates that the project archive file (archive.prj) is present on the inserted SD Card and that the contents of this file matches the loaded Project.						
FALSE indicates that either the project archive file is not on the SD Card or that the archive file does not contain the archive of the loaded Project.						
Extended Support	0117	Parameters::Device Manager::SD Card	TRUE			ALWAYS
Set TRUE to support a wider range of SD Cards. This parameter is ignored if Precision Time Protocol, (PTP), is enabled.						

Sequencing

Parameters::Motor Control::Sequencing

These parameters allow the user of the AC30V to monitor the status and affect the behaviour of the DS402 drive state machine as described in detail in Appendix B "Sequencing Logic".

Parameter Name	No.	Path	Default	Range	Units	Writable
Local	0591	Parameters::Motor Control::Sequencing	FALSE			STOPPED
Local (GKP) of Control and Reference.						
Local Power Up Mode	1565	Parameters::Motor Control::Sequencing	0	0:AS WHEN POWERED DOWN 1:LOCAL 2:REMOTE		ALWAYS
<p>The initial value of 0591 Local can be selected by the User using this enumerated parameter.</p> <p>0: AS WHEN POWERED DOWN the state when the Drive was powered down (default) 1: LOCAL always powers up with 0591 Local set to TRUE 2: REMOTE always powers up with 0591 Local set to FALSE</p>						
Local Reference	0592	Parameters::Motor Control::Sequencing	0.00	0.00 to 100.00	%	ALWAYS
Local Reference from GKP.						
App Control Word	0610	Parameters::Motor Control::Sequencing	0000	0:SWITCH ON 1:ENABLE VOLTAGE 2:NOT QUICKSTOP 3:ENABLE OPERATION 7:RESET FAULT 8:EXTERNAL FAULT 12:USE JOG REFERENCE 13:REVERSE DIRECTION 14:AUTO INITIALISE 15:EVENT TRIGGERED OP		ALWAYS
Control Word from Application (Terminals).						

C-188 Parameter Reference

Parameter Name	No.	Path	Default	Range	Units	Writable
Comms Control Word	0627	Parameters::Motor Control::Sequencing	0000	0:SWITCH ON 1:ENABLE VOLTAGE 2:NOT QUICKSTOP 3:ENABLE OPERATION 7:RESET FAULT 8:EXTERNAL FAULT 10:USE COMMS CONTROL 11:USE COMMS REFERENCE 12:USE JOG REFERENCE 13:REVERSE DIRECTION 14:AUTO INITIALISE 15:EVENT TRIGGERED OP		ALWAYS

Control Word from Fieldbus.

Control Word	0644	Parameters::Motor Control::Sequencing		0:SWITCH ON 1:ENABLE VOLTAGE 2:NOT QUICKSTOP 3:ENABLE OPERATION 7:RESET FAULT 8:EXTERNAL FAULT 10:USE COMMS CONTROL 11:USE COMMS REFERENCE 12:USE JOG REFERENCE 13:REVERSE DIRECTION 14:AUTO INITIALISE 15:EVENT TRIGGERED OP		NEVER
---------------------	------	---------------------------------------	--	--	--	-------

Monitor (read-only) Control Word updated from the active source.

Parameter Reference C-189

Parameter Name	No.	Path	Default	Range	Units	Writable
Status Word	0661	Parameters::Motor Control::Sequencing		0:READY TO SWITCH ON 1:SWITCHED ON 2:OPERATION ENABLED 3:FAULTED 4:VOLTAGE ENABLED 5:QUICKSTOP INACTIVE 6:SWITCH ON DISABLED 9:CONTROL FROM COMMS 12:JOG OPERATION 13:REVERSE OPERATION 14:REFERENCE FROM COMMS 15:STOPPING		NEVER

This is the DS402 Status Word

Sequencing State	0678	Parameters::Motor Control::Sequencing		0:NOT READY TO SWITCH ON 1:SWITCH ON DISABLED 2:READY TO SWITCH ON 3:SWITCHED ON 4:OPERATION ENABLED 5:QUICKSTOP ACTIVE 6:FAULT REACTION ACTIVE 7:FAULTED		NEVER
-------------------------	------	---------------------------------------	--	--	--	-------

Drive DS402 Sequencing State.

Switch On Timeout	0679	Parameters::Motor Control::Sequencing	0.000	0.000 to 100.000	s	ALWAYS
<p>Time allowed for line contactor to close when entering the Switched On state from Switched Off state. If this time is non-zero, a Line Contactor trip will occur if the DC Link Voltage remains low until the timeout expires. If the timeout is set to zero, an Under Voltage trip will occur immediately.</p>						

App Reference	0680	Parameters::Motor Control::Sequencing	0.00	-110.00 to 110.00	%	ALWAYS
<p>Reference from terminals (via. the application)</p>						

C-190 Parameter Reference

Parameter Name	No.	Path	Default	Range	Units	Writable
Comms Reference	0681	Parameters::Motor Control::Sequencing	0.00	-110.00 to 110.00	%	ALWAYS

Reference from Fieldbus

Reference	0682	Parameters::Motor Control::Sequencing	x.xx	-110.00 to 110.00	%	NEVER
------------------	------	---------------------------------------	------	-------------------	---	-------

Monitor (read-only) Reference updated from the active source. This will either be the value of the **0592 Local Reference**, **0680 App Reference** (terminals) or **0681 Comms Reference** depending on which source is currently selected.

Setup Wizard

Parameters::Device Manager::Setup Wizard

These parameters configure the operation of the **Setup Wizard**.

Parameter Name	No.	Path	Default	Range	Units	Writable
Enable Auto Save	1738	Parameters::Device Manager::Setup Wizard	TRUE			ALWAYS
<p>Control how parameter values are saved when modified via the GKP or the Web Page.</p> <p>TRUE: Parameter values are saved automatically when they are entered.</p> <p>FALSE: Parameter values are not saved automatically. To save parameters using the GKP navigate to the Welcome page by pressing the soft left key repeatedly, then press the save icon  for approximately 1s. (Note: If the GKP password is active and unlocked it will be necessary to lock the GKP password before the save icon is presented).</p>						
Auto Hide	1779	Parameters::Device Manager::Setup Wizard	TRUE			ALWAYS
<p>In normal operation, parameters that are not relevant to the configuration are saved. For example, parameters relating to the Thermistor IO option are only visible when that option is enabled. Clearing "Parameter Auto Hide" shows all parameters in the drive at ENGINEER view level. At other view levels the Auto Hide feature is always enabled.</p>						
Scaled PNO Access	1861	Parameters::Device Manager::Setup Wizard	0	0:BASE UNITS 1:SELECTED UNITS		ALWAYS
<p>This parameter may be used when the application makes use of selectable units, (for example: to display a value in either °C or °F). When Scaled PNO Access is "BASE UNITS" the value returned when reading a rescaled parameter over fieldbus communications is always in the base, (unscaled), units. When Scaled PNO Access is "SELECTED UNITS" the value returned when reading a rescaled parameter over fieldbus communications is in the selected units.</p>						

C-192 Parameter Reference

Parameter Name	No.	Path	Default	Range	Units	Writable
Language	1005	Parameters::Device Manager::Setup Wizard	0	0:ENGLISH 1:FRANCAIS 2:DEUTSCH 3:ESPANOL 4:ITALIANO 5:CHINESE 6:L 6 7:L 7 8:L 8 9:L 9		STOPPED
Identifies the currently selected language, refer to chapter 7, Graphical Keypad, for details on changing the selected language.						
Run Wizard?	1006	Parameters::Device Manager::Setup Wizard	1	0:NO 1:YES		ALWAYS
Changing this parameter to TRUE will cause the GKP to re-start the Setup Wizard. This parameter is automatically reset to FALSE on exiting the Setup Wizard.						
Save is Required	0411	Parameters::Device Manager::Setup Wizard				NEVER
Indicates that auto save is off, and a parameter has been changed. Used by PDD and PDQ to see if a parameter has been changed via the GKP or web page.						

Functional Description

The operation of the Setup Wizard is described in Chapter 9.

Skip Frequencies

Setup::Application::Skip Frequencies

Function availability depends on macro selected.

This function is used to prevent the Drive operating at frequencies that cause mechanical resonance in the load.

Parameter Name	No.	Path	Default	Range	Units	Writable
Skip Band 1	1908	Setup::Application::Skip Frequencies	0.0	0.0 to 1000.0	Hz	ALWAYS
The width of skip band 1 in Hz.						
Skip Frequency 1	1909	Setup::Application::Skip Frequencies	0.0	0.0 to 1000.0	Hz	ALWAYS
The centre frequency of skip band 1 in Hz.						
Skip Band 2	1910	Setup::Application::Skip Frequencies	0.0	0.0 to 1000.0	Hz	ALWAYS
The width of skip band 2 in Hz.						
Skip Frequency 2	1911	Setup::Application::Skip Frequencies	0.0	0.0 to 1000.0	Hz	ALWAYS
The centre frequency of skip band 2 in Hz.						
Skip Band 3	1912	Setup::Application::Skip Frequencies	0.0	0.0 to 1000.0	Hz	ALWAYS
The width of skip band 3 in Hz.						
Skip Frequency 3	1913	Setup::Application::Skip Frequencies	0.0	0.0 to 1000.0	Hz	ALWAYS
The centre frequency of skip band 3 in Hz.						
Skip Band 4	1914	Setup::Application::Skip Frequencies	0.0	0.0 to 1000.0	Hz	ALWAYS
The width of skip band 4 in Hz.						
Skip Frequency 4	1915	Setup::Application::Skip Frequencies	0.0	0.0 to 1000.0	Hz	ALWAYS
The centre frequency of skip band 4 in Hz.						

C-194 Parameter Reference

Functional Description

Four programmable skip frequencies are available to avoid resonances within the mechanical system. Enter the value of frequency that causes the resonance using a **Frequency** parameter and then program the width of the skip band using its **Band** parameter. The Drive will then avoid sustained operation within the forbidden band as shown in the diagram. The skip frequencies are symmetrical and thus work in forward and reverse.

Setting a **Frequency** to 0 disables the corresponding band. Setting a **Band** to 0 causes the value of **Band 1** to be used for this band.

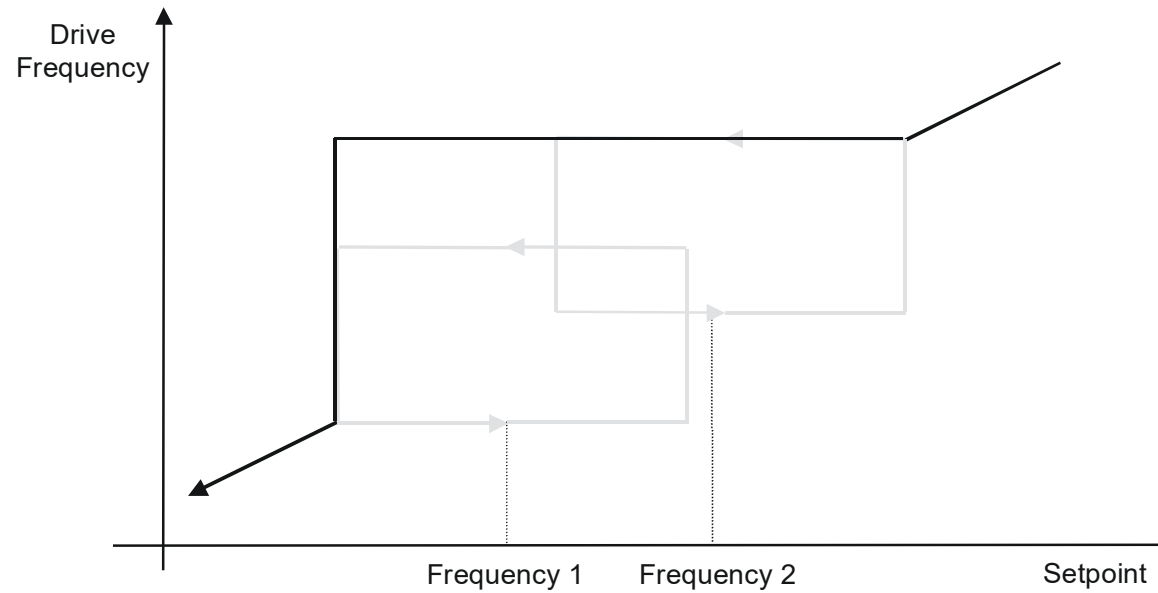

The behaviour of this function is illustrated below.

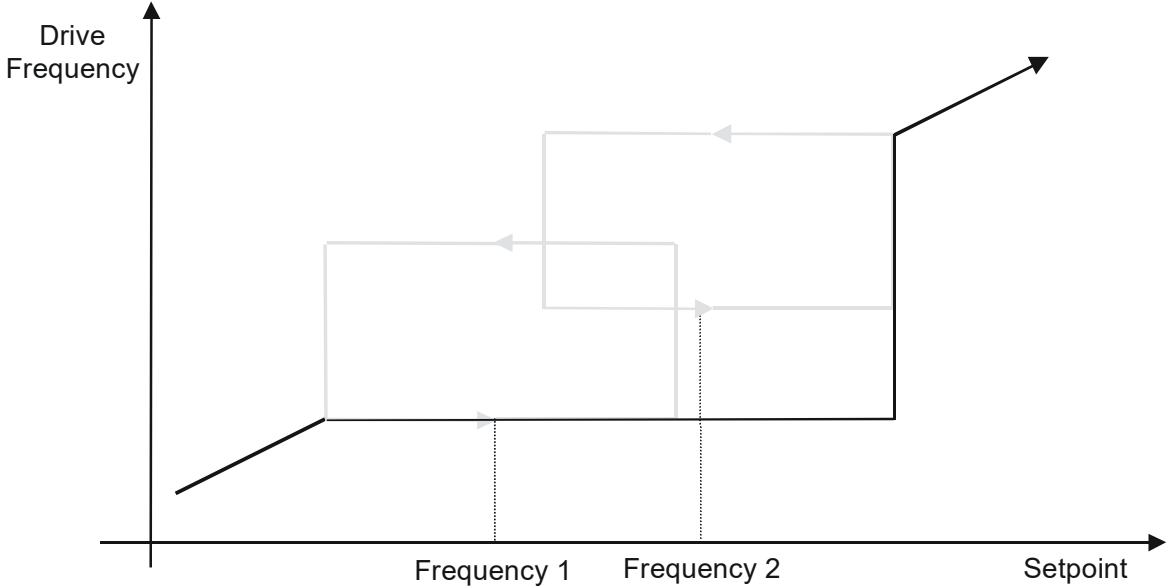
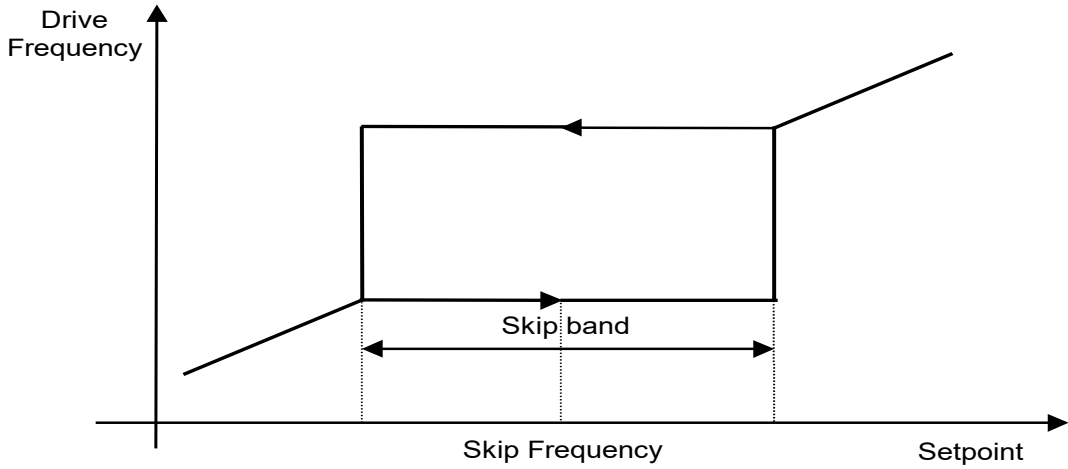

C-196 Parameter Reference

Slew Rate

Parameters::Motor Control::Slew Rate

Designed for VOLTS/Hz motor Control Mode.

This function prevents over-current and over-voltage faults occurring due to a rapidly changing setpoint.

Parameter Name	No.	Path	Default	Range	Units	Writable
Slew Rate Enable	0360	Parameters::Motor Control::Slew Rate	TRUE			ALWAYS
Enable/Disable slew rate limit						
Slew Rate Accel Limit	0361	Parameters::Motor Control::Slew Rate	500	1 to 1200	Hz/s	ALWAYS
Maximum rate at which the setpoint can be changed away from zero						
Slew Rate Decel Limit	0362	Parameters::Motor Control::Slew Rate	500	1 to 1200	Hz/s	ALWAYS
Maximum rate at which the setpoint can be changed towards zero						

Functional Description

The **Slew Rate** limit obtains the setpoint from the output of the application, correctly scaled by the **Reference** feature and already processed by the Power Loss Ride Thru and the **DC Link Volts Limit** features (if enabled). The rate of change limits are applied and the setpoint is then passed on for further processing.

When the braking feature determines that the internal dc link voltage is too high it issues a Hold signal. This causes the **Slew Rate** limit function to hold the setpoint at its current value. This typically lasts for only 1ms, time for the excess energy to be dumped into the dynamic braking resistor.

Speed Setpoint path

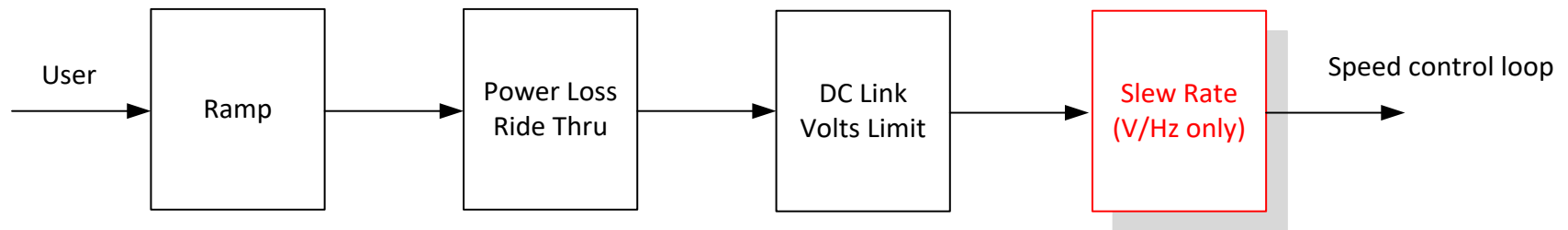

Slip Compensation

Parameters::Motor Control::Slip Compensation

Designed for VOLTS/Hz motor Control Mode.

The slip compensation function allows the Drive to maintain motor speed in the presence of increased load.

Parameter Name	No.	Path	Default	Range	Units	Writable
Slip Compensatn Enable	0354	Parameters::Motor Control::Slip Compensation	FALSE			ALWAYS
Enable/Disable slip compensation						
SLP Motoring Limit	0356	Parameters::Motor Control::Slip Compensation	150	0 to 600	RPM	ALWAYS
Maximum compensated speed in motor control						
SLP Regen Limit	0357	Parameters::Motor Control::Slip Compensation	150	0 to 600	RPM	ALWAYS
Maximum compensated speed in regen mode						

Functional Description

Based on the rated speed, the no load speed and the rated load of the motor, the **Slip Compensation** feature adjusts the demand frequency to compensate for any speed reduction resulting from the load.

C-198 Parameter Reference

SNTP Client

Parameters::Base Comms::STNP Client

Refer to Chapter 8: Ethernet

SNTP Server

Parameters::Base Comms::STNP Server

Refer to Chapter 8: Ethernet

Soft Menus

Parameters::Device Manager::Soft Menus

Parameter Name	No.	Path	Default	Range	Units	Writable
Control Screen Mode	0908	Parameters::Device Manager::Soft Menus	1	0:DISABLED 1:AUTO 2:CUSTOM		STOPPED

Defines the operation of the Control Screen

0. DISABLED
1. AUTO
2. CUSTOM

When set to DISABLED, the Control Screen menu is hidden.

When set to AUTO, the contents of the Control Screen menu depends on the sequencing mode of the drive, (local, remote or communications).

When set to CUSTOM, the contents of the Control Screen may be defined by writing parameter numbers to the elements of the **1352 Control Screen** array. Note that the contents of the **1352 Control Screen** array are not saved in non-volatile memory, so the values need to be initialised following a power-on reset.

Control Screen	1352	Parameters::Device Manager::Soft Menus				ALWAYS
-----------------------	------	--	--	--	--	--------

An array of PNOs that identifies the parameters to be shown in the Control Screen. The contents of this screen are set automatically by the AC30 firmware when the control mode is changed.

Favourites	1188	Parameters::Device Manager::Soft Menus				ALWAYS
-------------------	------	--	--	--	--	--------

An array of PNOs that identifies the parameters to be shown in the Favourites menu

Setup	1311	Parameters::Device Manager::Soft Menus				ALWAYS
--------------	------	--	--	--	--	--------



An array of PNOs that identifies the parameters to be shown in the Setup menu

C-200 Parameter Reference

Parameter Name	No.	Path	Default	Range	Units	Writable
Monitor	1270	Parameters::Device Manager::Soft Menus				ALWAYS

An array of PNOs that identifies the parameters to be shown in the Monitor menu

Functional Description

The Soft Menus group of parameters are used to populate the associated menus depending on the associated application, (Control Screen, Setup and Monitor) or the requirements of the location, (Favourites). The contents of the Setup and Monitor menus may only be set by the application itself. The contents of the Favourites menu may be set by writing to the parameters in the Favourites array. Alternatively parameters may be added to or removed from the Favourites menu by use of the GKP. Navigate to the parameter of interest and hold the OK key until the attributes screen is shown. If the parameter is not already in the Favourites menu a pressing Soft Key 2 adds the parameter to Favourites. This operation is indicated by the icon . Similarly, to remove a parameter from Favourites, navigate to the parameter in the Favourites menu then press OK until the parameter attributes are shown. Remove the parameter from Favourites by pressing Soft Key 2. This operation is indicated by the icon .

Spd Direct Input

Parameters::Motor Control::Spd Direct Input

Only apply to SVC control mode, IM or PMAC.

Parameter Name	No.	Path	Default	Range	Units	Writable
Direct Input Select	0528	Parameters::Motor Control::Spd Direct Input	0	0:NONE 1:ANIN1 2:ANIN2		ALWAYS

The direct input to the speed loop is an analog input which is sampled synchronously with the speed loop. This ensures that the speed loop always has the most up-to-date value of the input, allowing it to respond faster. Either of the two analog inputs can be selected as the direct input. If NONE is selected, the input is set to zero. When not in use, it should be disabled by selecting NONE.

Direct Input Ratio	0529	Parameters::Motor Control::Spd Direct Input	1.0000	-10.0000 to 10.0000		ALWAYS
---------------------------	------	---	--------	---------------------	--	--------

The Direct Input is multiplied by this parameter.

Direct Input Pos Lim	0530	Parameters::Motor Control::Spd Direct Input	110.00	-600.00 to 600.00	%	ALWAYS
-----------------------------	------	---	--------	-------------------	---	--------

This limits the upper value of the Direct Input.

Direct Input Neg Lim	0531	Parameters::Motor Control::Spd Direct Input	-110.00	-600.00 to 600.00	%	ALWAYS
-----------------------------	------	---	---------	-------------------	---	--------

This limits the lower value of the Direct Input.

Functional Description

The Drive is commanded to run the motor at a certain speed, which is derived from various sources, such as comms, analog inputs, commands from the keypad, etc. Most of these are derived from sources which respond relatively slowly, eg every 1ms. For processes which require a faster response, the direct input is provided. This is an analog input which is sampled synchronously with the speed loop, as described above. It is added on to the other sources of speed command to give a total speed command.

C-202 Parameter Reference

Spd Loop Diagnostics

Parameters::Motor Control::Spd Loop Diagnostics

Refer to the diagram in **Spd Loop Settings** function.

Only applies to SVC control mode, IM or PMAC.

Parameter Name	No.	Path	Default	Range	Units	Writable
Total Spd Demand RPM	0533	Parameters::Motor Control::Spd Loop Diagnostics	x.xx	-100000.00 to 100000.00	RPM	NEVER
This diagnostic shows the final values of the speed demand in rpm obtained after summing all sources. This is the value which is presented to the speed loop						
Total Spd Demand %	0534	Parameters::Motor Control::Spd Loop Diagnostics	x.xx	-200.00 to 200.00	%	NEVER
This diagnostic shows the final values of the speed demand as a % of 100% Speed in RPM of the Scale Setpoint obtained after summing all sources. This is the value which is presented to the speed loop.						
Speed Loop Error	0535	Parameters::Motor Control::Spd Loop Diagnostics	x.xx	-600.00 to 600.00	%	NEVER
This diagnostic shows the difference between the total speed demand and the speed feedback						
Speed PI Output	0536	Parameters::Motor Control::Spd Loop Diagnostics	x.xx	-600.00 to 600.00	%	NEVER
This diagnostic shows the difference between the total speed demand and the speed feedback						
Speed Limiter Active	0536	Parameters::Motor Control::Spd Loop Diagnostics	x.xx	-600.00 to 600.00	%	NEVER
This diagnostic is TRUE if the drive is in Torque Control mode (i.e. Sel Torq Ctrl Only is TRUE), the speed limiter validated (i.e. Spd Limiter Torq Ctrl is TRUE) and the drive is in speed limit condition.						

Spd Loop Settings

Parameters::Motor Control::Spd Loop Settings

This function block controls the speed of the motor by comparing the actual speed to the demanded speed, and applying more or less torque in response to the error.

Only applies to SVC control mode, IM or PMAC.

Parameter Name	No.	Path	Default	Range	Units	Writable
Speed Loop Auto Set	1246	Parameters::Motor Control::Spd Loop Settings	TRUE			ALWAYS
<p>Only for PMAC Motor</p> <p>TRUE : Allows to automatically calculate speed loop control parameters : Speed Loop Pgain and Speed Loop I Time.</p> <p>To do a correct estimation, Ratio Load Mot Inert should be correctly filled in.</p> <p>FALSE : no automatic calculation</p>						
Ratio Load Mot Inert	1247	Parameters::Motor Control::Spd Loop Settings	1.0	0.1 to 100.0		ALWAYS
<p>Only for PMAC Motor</p> <p>Enter the correct inertia ratio between the load and the motor (For a no load condition, a value of 0.1 should be used).</p> <p>This is used to automatically estimate the correct Speed Loop Pgain and Speed Loop I Time.</p>						
Speed Loop Bandwidth	1248	Parameters::Motor Control::Spd Loop Settings	1	0:LOW 1:MEDIUM 2:HIG		ALWAYS
<p>Only for PMAC Motor</p> <p>When Speed Loop Auto Set is TRUE, allows to select the speed loop bandwidth level :</p> <p>Low :provides a low speed loop bandwidth</p> <p>Medium : provides a medium speed loop bandwidth</p> <p>High : provides a high speed loop bandwidth</p>						

C-204 Parameter Reference

Parameter Name	No.	Path	Default	Range	Units	Writable
Speed Loop Pgain	0515	Parameters::Motor Control::Spd Loop Settings	20.00	0.00 to 3000.00		ALWAYS
<p>Sets the proportional gain of the loop.</p> <p>Speed error x proportional gain = torque percent.</p>						
Speed Loop I Time	0516	Parameters::Motor Control::Spd Loop Settings	0.100	0.001 to 15.000	s	ALWAYS
<p>This is the integral time constant of the speed loop. A speed error which causes the proportional term to produce a torque demand T, will cause the integral term to also ramp up to a torque demand T after a time equal to Speed Loop I Time.</p>						
Speed Loop Int Defeat	0517	Parameters::Motor Control::Spd Loop Settings	FALSE			ALWAYS
<p>When TRUE, the integral term does not operate.</p>						
Speed Loop Int Preset	0518	Parameters::Motor Control::Spd Loop Settings	0	-600 to 600		ALWAYS
<p>The integral term will be preset to this value when the drive starts.</p>						
Spd Loop Dmd Filt TC	0519	Parameters::Motor Control::Spd Loop Settings	0.0	0.0 to 15.0	ms	ALWAYS
<p>The speed demand is filtered to reduce ripple. The filter is first order with time constant equal to the value of this parameter.</p>						
Spd Loop Fbk Filt TC	0520	Parameters::Motor Control::Spd Loop Settings	1.0	0.0 to 15.0	ms	ALWAYS
<p>The speed feedback is filtered to reduce ripple. The filter is first order with time constant equal to the value of this parameter.</p>						

Parameter Reference C-205

Parameter Name	No.	Path	Default	Range	Units	Writable
Spd Loop Aux Torq Dmd	0521	Parameters::Motor Control::Spd Loop Settings	0.00	-600.00 to 600.00	%	ALWAYS
<p>When the drive is operating in speed control mode, the value of this parameter is added on to the torque demand produced by the speed loop PI. When the drive is operating in torque control mode (i.e. Set Torq Ctrl Only is TRUE) the speed loop PI does not operate, and the torque demand becomes the sum of this parameter plus the DIRECT INPUT (if selected).</p>						
Spd Loop Adapt Thres	0523	Parameters::Motor Control::Spd Loop Settings	0.00	0.00 to 10.00	%	ALWAYS
<p>If the speed demand is less than the Spd Loop Adapt Thres, the speed loop proportional gain is the Spd Loop Adapt Pgain.</p>						
Spd Loop Adapt Pgain	0524	Parameters::Motor Control::Spd Loop Settings	20.00	0.00 to 300.00		ALWAYS
<p>Proportional gain used if speed demand < Spd Loop Adapt Thres.</p>						
Spd Demand Pos Lim	0525	Parameters::Motor Control::Spd Loop Settings	110.00	-110.00 to 110.00	%	ALWAYS
<p>This sets the upper limit of the speed demand.</p>						
Spd Demand Neg Lim	0526	Parameters::Motor Control::Spd Loop Settings	-110.00	-110.00 to 110.00	%	ALWAYS
<p>This sets the lower limit of the speed demand.</p>						
Sel Torq Ctrl Only	0527	Parameters::Motor Control::Spd Loop Settings	FALSE			ALWAYS
<p>Selects between Speed Control mode and Torque Control mode. When TRUE, (Torque Control mode) the torque demand output from the speed loop feature is the sum of the Direct Input plus the Spd Loop Aux Torq Dmd parameter.</p>						

C-206 Parameter Reference

Parameter Name	No.	Path	Default	Range	Units	Writable
Spd Limiter Torq Ctrl	1781	Parameters::Motor Control::Spd Loop Settings	FALSE			ALWAYS

When set to TRUE, and the drive is in Torque Control mode, this parameter prevents operation outside the speed limits defined in Spd Demand Pos Lim and Spd Demand Neg Lim. The torque setpoint is compensated if the motor speed reaches these speed limits.

Functional Description

The speed error (speed demand minus speed feedback) is calculated and processed via a proportional + integral (PI) controller. The output of the PI controller is a torque demand, which is passed directly to the torque control feature.

When the drive is in SENSORLESS VEC mode, the speed feedback is calculated from the voltages and currents flowing in the motor, and the motor model.

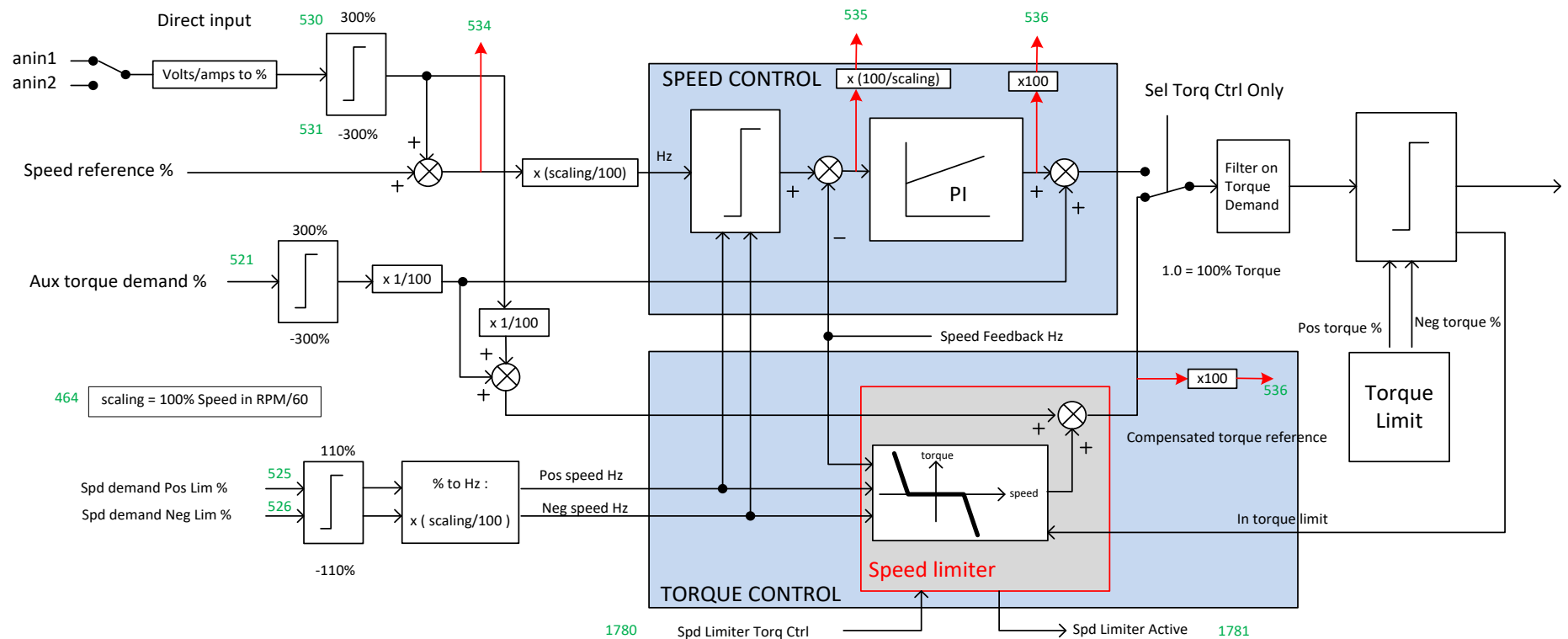

Speed Error Trip

Parameters::Trips::Speed Error Trip

This function allows the user to program the response of the drive in a situation where persistent speed error (as a difference between setpoint and actual measured or estimated speed) occurs.

Parameter Name	No.	Path	Default	Range	Units	Writable
Speed Error Trip Enable	1746	Parameters::Trips::Speed Error Trip	TRUE			ALWAYS
A boolean that enables the speed error trip.						
Speed Error Threshold	1747	Parameters::Trips::Speed Error Trip	50.00	0.00 to 100.00	%	ALWAYS
Level of speed error required to trigger the trip.						
Speed Error Trip Delay	1748	Parameters::Trips::Speed Error Trip	10.000	0.000 to 2000.000	s	ALWAYS
Time period after which the drive trips. After half of this time a warning is issued.						

Functional Description

If the difference between the setpoint and the actual motor speed is greater than a level defined in parameter 1747 (**Speed Error Threshold**) for a period longer than time defined in parameter 1748 (**Speed Error Trip Delay**), the drive will trip. After half of that period a warning will be produced. This is only operational if enabled via parameter 1746 (**Speed Error Trip Enable**).

C-208 Parameter Reference

Speed Ref

Parameters::Motor control::Speed Ref

This function holds all the parameters concerning the generation of the setpoint reference (reference ramp, speed trim, setpoint reverse, etc.).

Parameter Name	No.	Path	Default	Range	Units	Writable
Min Speed Clamp	1264	Parameters::Motor Control::Speed Ref	-110.00	-110.00 to 0.00	%	ALWAYS
Minimum value for Ramp Speed Output						
Max Speed Clamp	1265	Parameters::Motor Control::Speed Ref	110.00	0.00 to 110.00	%	ALWAYS
Maximum value for Ramp Speed Output						
Speed Trim	1266	Parameters::Motor Control::Speed Ref	0.00	-300.00 to 300.00	%	ALWAYS
The trim is added to the ramp output to form the Ramp Speed Output (unconditionally in remote mode). In local mode, it is added is the Ref Trim Local parameter is set to TRUE						
Trim in Local	1267	Parameters::Motor Control::Speed Ref	FALSE			ALWAYS
When TRUE, the trim is added to the ramp output in local mode. When FALSE, the trim is not added to the ramp output in local mode.						

Stabilisation

Parameters::Motor Control::Stabilisation

Designed for VOLTS/Hz motor Control Mode.

Parameter Name	No.	Path	Default	Range	Units	Writable
Stabilisation Enable	0364	Parameters::Motor Control::Stabilisation	TRUE			ALWAYS

Enable/Disable stabilisation

Functional Description

Enabling this function reduces the problem of unstable running in induction motors. This can be experienced at approximately half full speed, and under low load conditions.

C-210 Parameter Reference

Stack Inv Time

Parameters::Motor Control::Stack Inv Time

The purpose of the inverse time is to automatically reduce the drive current limit in response to prolonged overload conditions.

For a short time given by Short Overload Time, the drive is able to provide the Short Overload Level

For a long time given by Long Overload Time, the drive is able to provide the Long Overload Level

These 2 protections work in parallel, the output limit current is the maximum value if **Inv Time Active** = False. If **Inv Time Active** = True, the current limit is determined by Long Overload Level

the current limit is not yet ramped down. If already ramped down, the current limit is due to the long overload.

When the maximum overload value is reached, the inverse time current limit is ramped down. The rate at which the inverse time current limit is ramped to the Inv Aiming Point is defined by **Inv Time Down Rate**. When the overload condition disappears, the inverse time current limit is ramped up. The rate at which the inverse time current limit is ramped to the maximum value is defined by **Inv Time Up Rate**.

% Are all referring to drive/stack ratings.

Parameter Name	No.	Path	Default	Range	Units	Writable
100% Stk Current	0343	Parameters::Motor Control::Stack Inv Time	x.x	0.0 to 10000.0	A	NEVER
Stack rating in rms amps corresponding to 100% stack current						
Long Overload Level	0344	Parameters::Motor Control::Stack Inv Time	x.	0 to 200	%	NEVER
Overload value in % of the stack amps for long overload condition(*)						
Long Overload Time	0345	Parameters::Motor Control::Stack Inv Time		0.000 to 100000.000	s	NEVER
Maximum duration under long overload condition (typically 60s)						

Parameter Reference C-211

Parameter Name	No.	Path	Default	Range	Units	Writable
Short Overload Level	0346	Parameters::Motor Control::Stack Inv Time	x.	0 to 200	%	NEVER
Overload value in % of the stack amps for short overload condition(*)						
Short Overload Time	0347	Parameters::Motor Control::Stack Inv Time		0.000 to 10000.000	s	NEVER
Maximum duration under short overload condition (typically 3s)						
Inv Time Aiming Point	0348	Parameters::Motor Control::Stack Inv Time	105.00	0.00 to 125.00	%	ALWAYS
Current in % where the power stack can undertake the load current permanently						
Inv Time Output	0349	Parameters::Motor Control::Stack Inv Time	x.	0 to 600	%	NEVER
Actual output current limit as a % of the stack current						
Inv Time Up Rate	0350	Parameters::Motor Control::Stack Inv Time	5.000	0.000 to 120.000	s	STOPPED
Ramp value to ramp up current when overload condition disappears						
Inv Time Down Rate	0351	Parameters::Motor Control::Stack Inv Time	5.000	0.000 to 120.000	s	STOPPED
Ramp value to reach the aiming point under prolonged overload condition						
Inv Time Warning	0352	Parameters::Motor Control::Stack Inv Time				NEVER
The protection starts to integrate overload conditions						

C-212 Parameter Reference

Parameter Name	No.	Path	Default	Range	Units	Writable
Inv Time Active	0353	Parameters::Motor Control::Stack Inv Time				NEVER

The drive protection is limiting the output current

(*) : Depending on the frame size, overload capabilities are reduced when the electrical speed is below 3Hz and with the heatsink temperature. Refer to Parker Hannifin Manufacturing for detailed values.

Above 3Hz electrical speed, overload capabilities are those defined by the **0390 Duty Selection**.

Functional Description

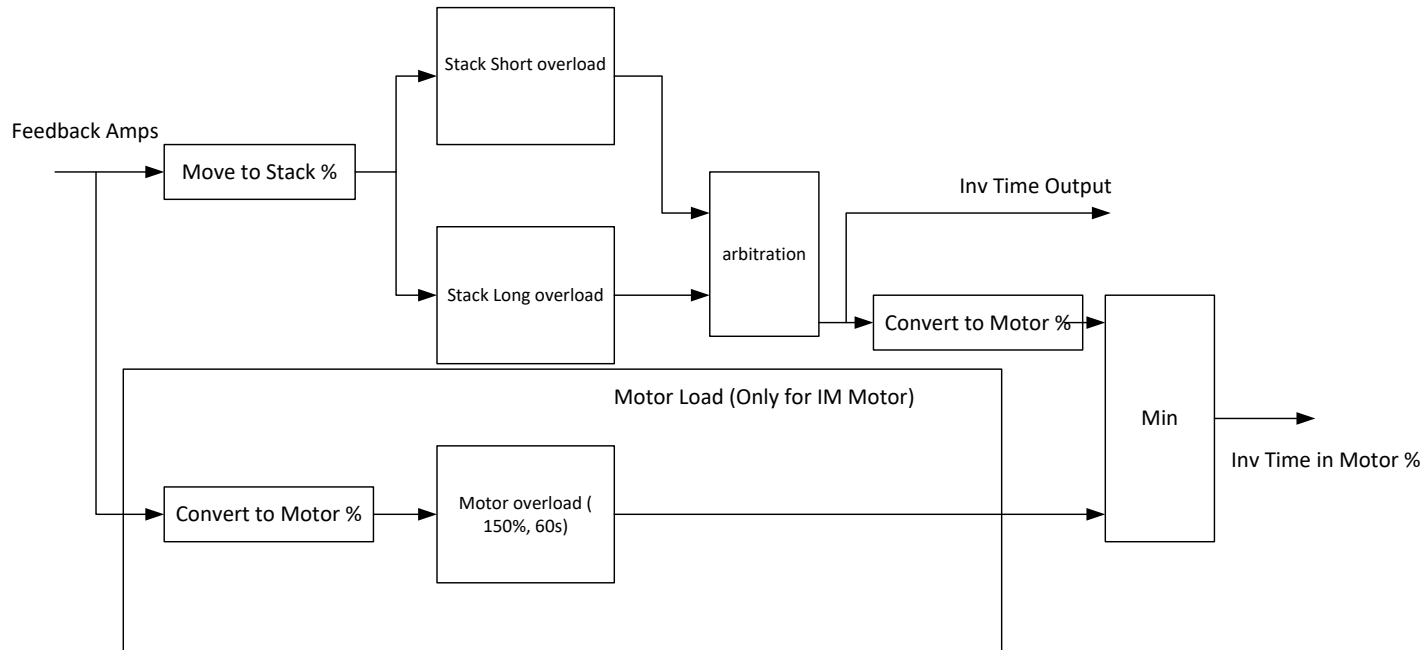

Short Overload : is using 180% of the Heavy Duty rating, for 3s.

Long Overload : is using the overload mode selected in **0390 Duty Selection**.

Inv Time in Motor % is used to limit the current. It is one of the inputs of the **Current Limit** Function features

Stall Trip

Parameters::Trips::Stall Trip

The function protects the motor from damage that may be caused by continuous operation beyond specification.

Parameter Name	No.	Path	Default	Range	Units	Writable
Stall Limit Type	0906	Parameters::Trips::Stall Trip	2	0:TORQUE 1:CURRENT 2:TORQUE OR CURRENT		ALWAYS
This parameter determines whether the stall trip operates on motor torque, on motor current, on motor torque or motor current.						
Stall Time	0907	Parameters::Trips::Stall Trip	90.000	0.100 to 2000.000	s	ALWAYS
The time after which a stall condition will cause a trip.						
Stall Torque Active	0909	Parameters::Trips::Stall Trip				NEVER
TRUE if tripped under torque trip operation						
Stall Current Active	0910	Parameters::Trips::Stall Trip				NEVER
TRUE is tripped under current trip operation						
Stall Speed Feedback	0911	Parameters::Trips::Stall Trip	x.	-200 to 200	%	NEVER
A copy of the speed Feedback in Hz						

Functional Description

If Stall Limit Type is set to TORQUE and the estimated load exceeds the active TORQUE LIMIT for a time greater than **Stall Time**, then the stall trip will become active.

If the Stall Limit Type is set to CURRENT and the measured current exceeds the active Current Limit for a time greater than **Stall Time**, then the stall trip will become active.

C-214 Parameter Reference

System Board Option

Parameters::System Board::System Board Option

Parameter Name	No.	Path	Default	Range	Units	Writable
System Board Required	1739	Setup::Inputs and Outputs::System Board Option Parameters::System Board::System Board Option		0:NONE 1:DUAL ENCODER 2:ABSOLUTE		CONFIG
Identifies whether the system board is required by the configuration.						
System Board Fitted	1740	Parameters::System Board::System Board Option		Same as PNO 1739		NEVER
Indicates whether the system board is attached. The system board is a factory fit option.						
System Board Status	1741	Parameters::System Board::System Board Option		0:OK 1:OPTION NOT FITTED 2:TYPE MISMATCH 3:TYPE UNKNOWN 4:HARDWARE FAULT		NEVER
Indicates the health of the system board, if attached.						

Functional Description

These parameters are used to set and verify the **System Board Option** configuration. If the status parameter is not OK then the drive will not enter the Operational state.

Status	Description
OK	The configuration is valid. The status will always be OK if no System Board option is required, even if one is fitted.
OPTION NOT FITTED	An option was required and none was detected
TYPE MISMATCH	The fitted option does not support the required features
TYPE UNKNOWN	The firmware in the drive does not recognise the fitted option
HARDWARE FAULT	The fitted option is not working as expected.

Thermistor**Setup::Inputs and Outputs::Option****Parameters::Option IO::Thermistor**

Parameter Name	No.	Path	Default	Range	Units	Writable
Thermistor Type	1184	Setup::Inputs and Outputs::Option Parameters::Option IO::Thermistor	1	0:NTC 1:PTC 2:KTY		ALWAYS
<p>Defines the thermistor type. This is used when generating the MOTOR OVERTEMP trip.</p> <p>NTC, (Negative Temperature Co-efficient) PTC, (Positive Temperature Co-efficient) KTY, (a linear temperature measuring device).</p>						
Thermistor Resistance	1185	Parameters::Option IO::Thermistor	x.	0 to 5000	Ohm	NEVER
<p>The resistance measured across the thermistor terminals.</p>						
Thermistor Trip Level	1004	Parameters::Option IO::Thermistor	1000	0 to 4500	Ohm	ALWAYS
<p>Defines the level at which a Motor Over Temperature trip will be generated. The default value is appropriate for PTC and NTC thermistor types.</p>						
Thermistor Warn Delta	1762	Parameters::Option IO::Thermistor	100	0 to 4500	Ohm	ALWAYS
<p>Defines the level at which a Motor Over Temperature warning will be generated. This is an offset from the trip level. For PTC and KTY thermistors, the warning level is the result of subtracting the Warning Delta value from the Trip Level. For NTC thermistors the warning level is the sum of Warning Delta and the Trip Level.</p>						

C-216 Parameter Reference

Torque Limit

Parameters::Motor Control::Torque Limit

This function allows you to set the maximum level of motor rated torque which is allowed before torque limit action occurs. If the estimated motor torque is greater than the **Actual Pos Torque Lim** value, the motor speed is controlled to maintain the torque at this level. A similar situation occurs if the estimated motor torque is less than the **Actual Neg Torque Lim** value.

The torque limit function has separate positive and negative torque limits. In addition, a symmetric main torque limit is also provided. The lowest positive and negative torque limits (including any current limit or inverse time current limit action) is indicated in the **Actual Pos Torque Lim** and **Actual Neg Torque Lim** diagnostic. These values determine the absolute motor torque limits.

<i>Parameter Name</i>	<i>No.</i>	<i>Path</i>	<i>Default</i>	<i>Range</i>	<i>Units</i>	<i>Writable</i>
Positive Torque Lim	0415	Parameters::Motor Control::Torque Limit	150.0	-600.0 to 600.0	%	ALWAYS
This parameter sets the maximum allowed level of positive motor torque.						
Negative Torque Lim	0416	Parameters::Motor Control::Torque Limit	-150.0	-600.0 to 600.0	%	ALWAYS
This parameter sets the maximum allowed level of negative motor torque						
Main Torque Lim	0417	Setup::Motor Control::Control and Type Parameters::Motor Control::Torque Limit	150.0	0.0 to 600.0	%	ALWAYS
This parameter sets the symmetric limit on the maximum allowed motor torque.						
Fast Stop Torque Lim	0418	Parameters::Motor Control::Torque Limit	150.0	0.0 to 600.0	%	ALWAYS
This parameter sets the torque limit used during a Quickstop.						
Symmetric Torque Lim	0419	Parameters::Motor Control::Torque Limit	FALSE			ALWAYS
When TRUE, the Negative Torque Lim is forced to reflect the Positive Torque Lim parameter.						

Parameter Reference C-217

Parameter Name	No.	Path	Default	Range	Units	Writable
Actual Pos Torque Lim	0420	Monitor::Motor and Drive Parameters::Motor Control::Torque Limit	x.x	-600.0 to 600.0	%	NEVER

This diagnostic indicates the final actual positive torque limit including any current limit or inverse time current limit action.

Actual Neg Torque Lim	0421	Same as PNO 420	x.x	-600.0 to 600.0	%	NEVER
------------------------------	------	-----------------	-----	-----------------	---	-------

This diagnostic indicates the final actual negative torque limit including any current limit or inverse time current limit action.

C-218 Parameter Reference

Functional Description

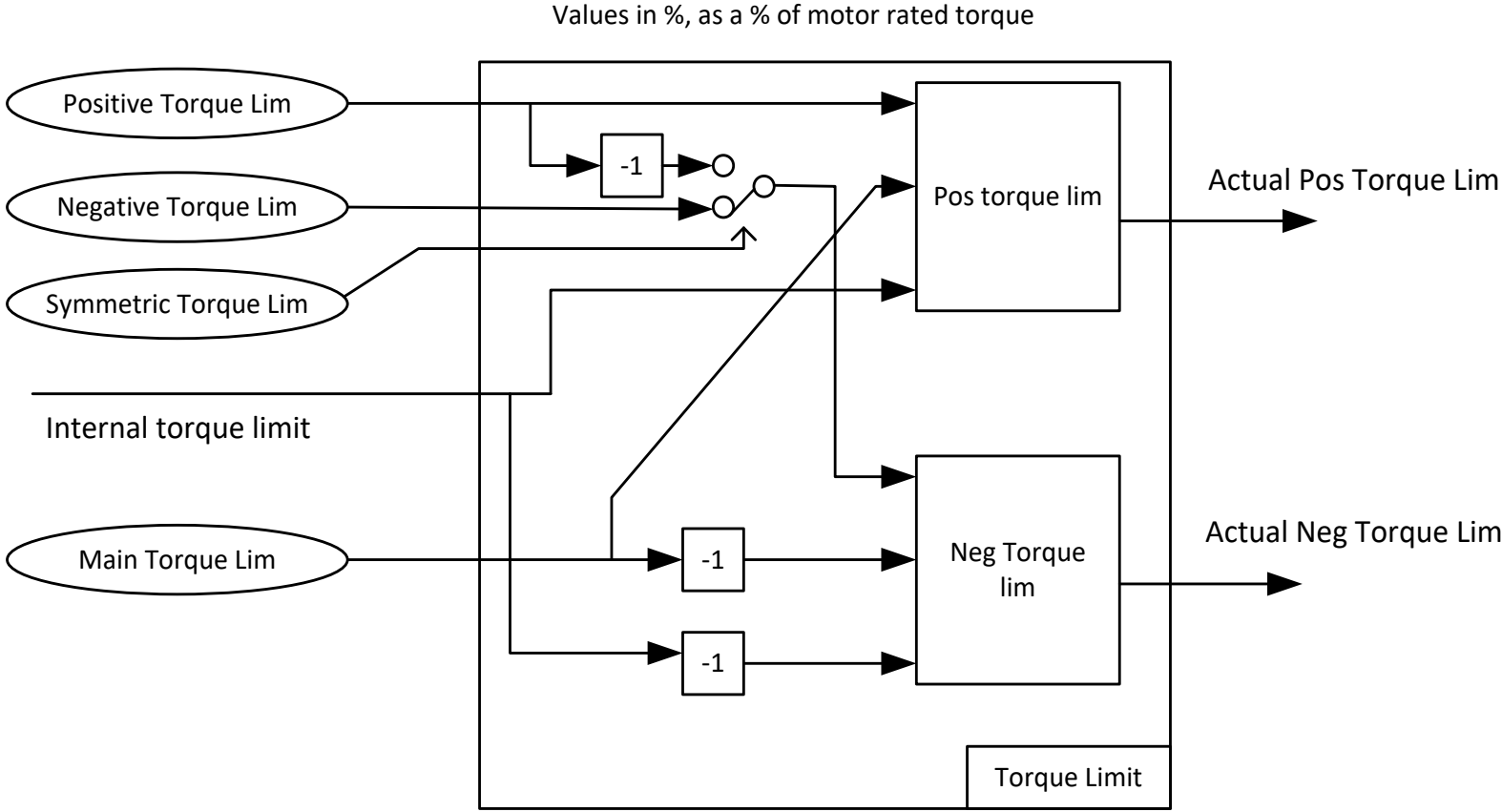

Tr Adaptation

Parameters::Motor Control::Tr Adaptation

When the motor control strategy is set to Closed Loop vector, i.e. using encoder feedback, it is important to know the actual value of the rotor time constant. This value is measured by the autotune, but it will change as the motor temperature changes. The purpose of this module is to track the changing value of the rotor time constant, and to use all available feedback information to make the best possible estimate of its actual value at any given time.

Parameter Name	No.	Path	Default	Range	Units	Writable
Actual Rotor T Const	1520	Parameters::Motor Control::Tr Adaptation	x.	1 to 100000	ms	NEVER
<p>This diagnostic shows the actual value of rotor time constant used by the motor control. This value is the nominal value stored in the Induction Motor Data, modified by this module to give a value as close as possible to the real value.</p>						
Tr Adaptation Output	1521	Parameters::Motor Control::Tr Adaptation	x.	1 to 500	%	NEVER
<p>This diagnostic shows the factor by which the nominal rotor time constant is multiplied, in order to give the actual rotor time constant passed to the motor control.</p>						
Demanded Terminal Volts	1528	Parameters::Motor Control::Tr Adaptation	x.	0 to 1000	V	NEVER
<p>In order to maintain constant flux for a given load, the motor terminal volts must be controlled. This diagnostic gives the terminal volts demand used by the control loop.</p>						
Terminal Volts	1529	Parameters::Motor Control::Tr Adaptation	x.	0 to 1000	V	NEVER
<p>This diagnostic shows motor terminal volts. It is included here for convenience, to compare with the demanded terminal volts to make sure that the terminal volts control loop is able to close the loop to the demanded value.</p>						
Max Available Volts	1527	Parameters::Motor Control::Tr Adaptation	x.	0 to 10000	V	NEVER
<p>This diagnostic shows the maximum achievable value of motor terminal volts. So for example, when running at rated load, the required motor terminal volts may be 400v. But if the mains is low, the maximum achievable volts may only be 390v. This diagnostic shows what is achievable at any particular time, and may be useful to explain why the motor volts may be lower than expected.</p>						

C-220 Parameter Reference

Trips History

Parameters::Trips::Trips History

Parameter Name	No.	Path	Default	Range	Units	Writable
Recent Trips	0895	Parameters::Trips::Trips History				NEVER
<p>The Recent Trips array is a record of the last 10 faults that caused the drive to disable the stack. Each entry has the same format as the First Trip parameter, (see Trips Status). The most recent fault is the first entry in the array, (Recent Trips[0]).</p>						
Recent Trip Times	1442	Parameters::Trips::Trips History				NEVER
<p>The time of each of the recent trips. If PNO1186 Time and Date is valid then this value is used, otherwise the time used is a snapshot of the Control Board Up Time, see Runtime Statistics.</p>						
Warranty Trips	0968	Parameters::Trips::Trips History				NEVER
<p>The Warranty Trips array is a record of the last 3 drive protection trips that were ignored due to the trip being disabled. This will usually be because Fire Mode (see Chapter 13) is enabled. Each entry has the same format as the First Trip parameter, (see Trips Status). The most recent fault is the first entry in the array, (Warranty Trips[0]).</p>						
Warranty Trip Time	0972	Parameters::Trips::Trips History				NEVER
<p>The time of each of the Warranty Trips. The time saved is a shapshot of the HV SMPS Up Time, see Runtime Statistics.</p>						
Warranty Trips Record	1408	Parameters::Trips::Trips History		0:01 OVER VOLTAGE 2:03 OVER CURRENT 3:04 STACK FAULT 4:05 STACK OVER CURRENT 7:08 INVERSE TIME 10:11 HEATSINK OVERTEMP 11:12 INTERNAL OVERTEMP 14:15 BRAKE SHORT CCT 16:17 BRAKE SWITCH 21:22 VDC RIPPLE		NEVER
<p>Records all drive protection trip event that have been ignored due to the trip being disabled. This will usually be because Fire Mode is enabled. Each entry has the same format as the Active 1 – 32 parameter, (see Trips Status).</p>						

Functional Description

These parameters indicate the fault history of the drive. They are preserved through a power failure.

The Warranty Trip parameters are also saved on the power stack. If the Control Module is attached to a power stack when it is powered on then the Warranty Trip parameter values are loaded from non-volatile memory on the power stack.

Trips Status

Parameters::Trips::Trips Status

Parameter Name	No.	Path	Default	Range	Units	Writable
First Trip	0696	Monitor::Trips Parameters::Trips::Trips Status		0:NONE	NEVER	
				1:01 OVER VOLTAGE		
				2:02 UNDER VOLTAGE		
				3:03 OVER CURRENT		
				4:04 STACK FAULT		
				5:05 STACK OVER CURRENT		
				6:06 CURRENT LIMIT		
				7:07 MOTOR STALL		
				8:08 INVERSE TIME		
				9:09 MOTOR I2T		
				10:10 LOW SPEED I		
				11:11 HEATSINK OVERTEMP		
				12:12 INTERNAL OVERTEMP		
				13:13 MOTOR OVERTEMP		
				14:14 EXTERNAL TRIP		
				15:15 BRAKE SHORT CCT		
				16:16 BRAKE RESISTOR		
				17:17 BRAKE SWITCH		
				18:18 LOCAL CONTROL		
				19:19 COMMS BREAK		
				20:20 LINE CONTACTOR		
				21:21 PHASE FAIL		
				22:22 VDC RIPPLE		
				23:23 BASE MODBUS BREAK		
				24:24 24 V OVERLOAD		
				25:25 PMAC SPEED ERROR		
				26:26 OVERSPEED		
				27:27 STO ACTIVE		
				28:28 FEEDBACK MISSING		
				29:29 INTERNAL FAN FAIL		
				30:30 CURRENT SENSOR		
				31:31 POWER LOSS STOP		
32:32 SPEED SENSOR						
33:33 A1						
34:34 A2						
35:35 A3						
36:36 A4						
37:37 A5						
38:38 A6						
39:39 A7						
40:40 A8						
41:41 SPEED ERROR						
42:42 PEERTOPEER OVERRUN						
43:43 PHASE CONFIG						
44:44 FIELD BUS BREAK						
45:45 RESOLVER ERROR						
46:46 PMAC ALIGN ERROR						
47:47 CURRENT IMBALANCE						
48:48 CONFIGURATION						
49:49 APPLICATION						
50:50 AC30A ENCODER						
51:51 CPU USAGE						

An enumerated value that shows the trip that caused the AC30 to disable the stack. When multiple trips are active at the same time, (for example Over Current followed by Over Temperature), this parameters shows the first trip that the AC30 detected. Refer to Chapter 10 “Trips and Fault Finding”, for details of each trip source.

C-222 Parameter Reference

Parameter Name	No.	Path	Default	Range	Units	Writable
Enable 1 - 32	0697	Parameters::Trips::Trips Status	FFFFFF7F	5:06 CURRENT LIMIT		ALWAYS
				6:07 MOTOR STALL		
				7:08 INVERSE TIME		
				8:09 MOTOR I2T		
				9:10 LOW SPEED I		
				11:12 INTERNAL OVERTEMP		
				12:13 MOTOR OVERTEMP		
				13:14 EXTERNAL TRIP		
				14:15 BRAKE SHORT CCT		
				15:16 BRAKE RESISTOR		
				16:17 BRAKE SWITCH		
				17:18 LOCAL CONTROL		
				18:19 COMMS BREAK		
				19:20 LINE CONTACTOR		
				20:21 PHASE FAIL		
				21:22 VDC RIPPLE		
				22:23 BASE MODBUS BREAK		
23:24 24 V OVERLOAD						
24:25 PMAC SPEED ERROR						
25:26 OVERSPEED						
28:29 INTERNAL FAN FAIL						
29:30 CURRENT SENSOR						
30:31 POWER LOSS STOP						
31:32 SPEED SENSOR						

A 32-bit word that can be used to enable, (or disable), individual trips. Refer to Chapter 10 “Trips and Fault Finding” for details of the value corresponding to each trip.

Enable 33 - 64	0730	Parameters::Trips::Trips Status	FFFFFFF	0:33 A1		ALWAYS
				1:34 A2		
				2:35 A3		
				3:36 A4		
				4:37 A5		
				5:38 A6		
				6:39 A7		
				7:40 A8		
				8:41 SPEED ERROR		
				9:42 PEERTOPEER OVERRUN		
				10:43 PHASE CONFIG		
				11:44 FIELD BUS BREAK		
				14:47 CURRENT IMBALANCE		
				16:49 APPLICATION		
				18:51 CPU USAGE		

A 32-bit word that can be used to enable, (or disable), individual trips. Bit 0 of this word corresponds to trip 33, up to bit 31 of this word which corresponds to trip 64.

Refer to Chapter 10 “Trips and Fault Finding” for details of the value corresponding to each trip.

Parameter Reference C-223

Parameter Name	No.	Path	Default	Range	Units	Writable
Active 1 - 32	0763	Monitor::Trips Parameters::Trips::Trips Status		0:01 OVER VOLTAGE 1:02 UNDER VOLTAGE 2:03 OVER CURRENT 3:04 STACK FAULT 4:05 STACK OVER CURRENT 5:06 CURRENT LIMIT 6:07 MOTOR STALL 7:08 INVERSE TIME 8:09 MOTOR I2T 9:10 LOW SPEED I 10:11 HEATSINK OVERTEMP 11:12 INTERNAL OVERTEMP 12:13 MOTOR OVERTEMP 13:14 EXTERNAL TRIP 14:15 BRAKE SHORT CCT 15:16 BRAKE RESISTOR 16:17 BRAKE SWITCH 17:18 LOCAL CONTROL 18:19 COMMS BREAK 19:20 LINE CONTACTOR 20:21 PHASE FAIL 21:22 VDC RIPPLE 22:23 BASE MODBUS BREAK 23:24 24 V OVERLOAD 24:25 PMAC SPEED ERROR 25:26 OVERSPEED 26:27 STO ACTIVE 27:28 FEEDBACK MISSING 28:29 INTERNAL FAN FAIL 29:30 CURRENT SENSOR 30:31 POWER LOSS STOP 31:32 SPEED SENSOR		NEVER

A 32-bit word that indicates which trip sources are active. For example, the HEATSINK OVERTEMP may remain true for some time after the initial fault is reported.

The Active value shows active trip sources even if the corresponding trip is not enabled in “Enabled 1-32”.

Refer to Chapter 10 “Trips and Fault Finding” for details of the value corresponding to each trip.

Active 33 - 64	0513	Monitor::Trips Parameters::Trips::Trips Status				NEVER
-----------------------	------	---	--	--	--	-------

A 32-bit word that indicates trip sources that are active. Bit 0 of this word corresponds to trip 33, up to bit 31 of this word which corresponds to trip 64.

C-224 Parameter Reference

Parameter Name	No.	Path	Default	Range	Units	Writable
Warnings 1 - 32	0829	Monitor::Trips Parameters::Trips::Trips Status		0:01 OVER VOLTAGE		NEVER
				1:02 UNDER VOLTAGE		
				2:03 OVER CURRENT		
				3:04 STACK FAULT		
				4:05 STACK OVER CURRENT		
				5:06 CURRENT LIMIT		
				6:07 MOTOR STALL		
				7:08 INVERSE TIME		
				8:09 MOTOR I2T		
				9:10 LOW SPEED I		
				10:11 HEATSINK OVERTEMP		
				11:12 INTERNAL OVERTEMP		
				12:13 MOTOR OVERTEMP		
				13:14 EXTERNAL TRIP		
				14:15 BRAKE SHORT CCT		
				15:16 BRAKE RESISTOR		
				16:17 BRAKE SWITCH		
				17:18 LOCAL CONTROL		
				18:19 COMMS BREAK		
				19:20 LINE CONTACTOR		
				20:21 PHASE FAIL		
				21:22 VDC RIPPLE		
				22:23 BASE MODBUS BREAK		
				23:24 24 V OVERLOAD		
				24:25 PMAC SPEED ERROR		
				25:26 OVERSPEED		
				26:27 STO ACTIVE		
				27:28 FEEDBACK MISSING		
				28:29 INTERNAL FAN FAIL		
				29:30 CURRENT SENSOR		
				30:31 POWER LOSS STOP		
				31:32 SPEED SENSOR		

A 32-bit word that indicates trip sources that are close to a fault condition. For example, the heat sink fault monitoring firmware reports a HEATSINK OVERTEMP warning when the heat sink temperature gets close to the heat sink fault level.

The Warnings value is not affected by the trip enable mask, "Enabled 1-32".

Refer to Chapter 10 "Trips and Fault Finding" for details of the value corresponding to each trip.

Parameter Name	No.	Path	Default	Range	Units	Writable
Warnings 33 - 64	0514	Same as PNO 513				NEVER
<p>A 32-bit word that indicates trip sources that are close to a fault condition. Bit 0 of this word corresponds to trip 33, up to bit 31 of this word which corresponds to trip 64.</p> <p>The Warnings value is not affected by the corresponding trip enable mask, "Enabled 33-64".</p> <p>Refer to Chapter 10 "Trips and Fault Finding" for details of the value corresponding to each trip.</p>						
Show Warnings 1 - 32	0115	Parameters::Trips::Trips Status	FFFFFFF			ALWAYS
<p>A 32-bit word that defines which warnings are to be displayed on the GKP. The bit definitions match those of PNO 0829. This parameter is over-ridden by setting PNO 1760 "Display Warnings" to FALSE.</p>						
Show Warnings 33 - 64	0116	Parameters::Trips::Trips Status	FFFFFFF			ALWAYS
<p>A 32-bit word that defines which warnings are to be displayed on the GKP. The bit definitions match those of PNO 0514. This parameter is over-ridden by setting PNO 1760 "Display Warnings" to FALSE.</p>						
Display Warnings	1760	Parameters::Trips::Trips Status	TRUE			ALWAYS
<p>When this parameter is TRUE, warnings are reported on the GKP as a message that hides any parameter display, (until the message is manually acknowledged). Set this parameter to FALSE to prevent warning messages being shown on the GKP.</p>						

C-226 Parameter Reference

VDC Ripple

Parameters::Trips::VDC Ripple

This function contains parameters and data associated to the VDC ripple detection and trip condition

Parameter Name	No.	Path	Default	Range	Units	Writable
VDC Ripple Filter TC	0912	Parameters::Trips::VDC Ripple	1.000	0.100 to 100.000	s	ALWAYS
Time constant of the First order Low pass filter applied to the raw VDC Ripple						
VDC Ripple Trip Hyst	0915	Parameters::Trips::VDC Ripple	10	0 to 50	V	ALWAYS
Hysteresis on the VDC ripple level for trip condition.						
VDC Ripple Sample	0916	Parameters::Trips::VDC Ripple	0.009	0.001 to 0.100	s	ALWAYS
Time Windows for peak to peak VDC voltage capture and ripple calculation						
Max VDC Ripple	0913	Parameters::Trips::VDC Ripple	x.	0 to 500	V	NEVER
Voltage ripple trigger value associated to the VDC ripple trip						
VDC Ripple Trip Delay	0914	Parameters::Trips::VDC Ripple		0.000 to 300.000	s	NEVER
Delay to trip if trip condition detected						
VDC Ripple Level	917	Parameters::Trips::VDC Ripple		0 to 500	V	NEVER
Actual raw VDC ripple level						
Filtered VDC Ripple	0918	Parameters::Trips::VDC Ripple	x.	0 to 500	V	NEVER
Actual filtered VDC ripple level						

Voltage Control

Parameters::Motor Control::Voltage Control

Designed for VOLTS/Hz motor Control Mode.

This function allows the motor output volts to be controlled in the presence of dc link voltage variations. This is achieved by controlling the level of PWM modulation as a function of measured dc link volts. The dc link volts may vary either due to supply variations or regenerative braking by the motor.

Three control modes are available, None, Fixed and Automatic.

<i>Parameter Name</i>	<i>No.</i>	<i>Path</i>	<i>Default</i>	<i>Range</i>	<i>Units</i>	<i>Writable</i>
Terminal Voltage Mode	0371	Parameters::Motor Control::Voltage Control	0	0:NONE 1:FIXED 2:AUTOMATIC		ALWAYS
Selection of voltage control mode						
Motor Base Volts	0374	Parameters::Motor Control::Voltage Control	100.00	0.00 to 115.47	%	ALWAYS
Scale of the output voltage						

C-228 Parameter Reference

Web Server

Setup::Communications::Base Ethernet

Setup::Environment

Parameters::Base Comms::Web Server

Refer to Chapter 8 “Ethernet”.

Parameter Tables

This table is a complete list of all the parameters in the AC30V.

PNO: The parameter number, a unique identifier for this parameter.

Name: The parameter's name as it appears on the GKP and web page.

Path(s): The navigation path(s) to this parameter on the GKP and web page.

Type: The data type of the parameter.

Data Type	Description
BOOL	A Boolean quantity representing FALSE or TRUE. (A zero value is FALSE).
SINT	A signed integer with a maximum range of -128 to +127.
INT	A signed integer with a maximum range of -32768 to +32767
DINT	A signed integer with a maximum range of -2147483648 to +2147483647
USINT ⁽¹⁾	An unsigned integer with a maximum range of 0 to 255
UINT	An unsigned integer with a maximum range of 0 to 65535
UDINT	An unsigned integer with a maximum range of 0 to 4294967295
REAL	A 32-bit floating point conforming to IEEE-754
TIME	A duration with a resolution of 1 ms and a maximum range of 0.000s to 4294967.295s, (about 50 days)
DATE	Date with a maximum range of 1 st Jan 1970 to 2037.
TIME_OF_DAY	Time of day
DATE_AND_TIME	Date and time of day with a maximum range of 1 st Jan 1970 to 2037
STRING	String
BYTE	Bit string length 8
WORD ⁽²⁾	Bit string length 16
DWORD ⁽²⁾	Bit string length 32

- (1) Some parameters of type USINT use discrete integer values to enumerate given states. For example; PNO 0001, the analog input hardware configuration may be set to 0, 1, 2 or 3 corresponding to the supported ranges. Such parameters have the available selections shown in the Range column.
- (2) Some Bit string parameters have the individual bits within the word assigned independently to separate functionality. For example PNO 0005 presents the state of all digital inputs in one 16-bit word. The bits may be individually accessed on the GKP and webpage by expanding the parameter. Each individual feature may be accessed as a Boolean via any fieldbus communications link by referencing the dedicated PNO.

Default: The default value of the parameter.

C-230 Parameter Reference

Range: The minimum and maximum values for this parameter. This column is also used to detail the available selection for enumerated integer types and named bits in bit string data types.

Units: The units text displayed with this parameter value.

WQ: The write qualifier.

ALWAYS The parameter has no write restrictions

STOPPED The parameter is only writable when the motor is not being controlled

CONFIG The parameter may only be written when the drive is in CONFIGURATION mode (NOT READY TO SWITCH ON)

NEVER The parameter is monitor only

View: Indicates when the parameter is visible on the GKP or the Web page.

Parameters that are not relevant to the current drive's configuration may be hidden regardless of the View level.

OPERATOR The parameter is always visible.

TECHNICIAN The parameter is visible when the view level is set to OPERATOR or TECHNICIAN

ENGINEER The parameter is visible when the view level is set to OPERATOR, TECHNICIAN or ENGINEER

Mbus: The Modbus register number corresponding the this PNO.

Notes:

- 1.The parameter is automatically saved before power down
- 2.Input parameter is not saved.
- 3.Output parameter is saved.
- 4.Parameter is hidden depending on the drive configuration.
- 5.Parameter is cloned as part of the "Other Parameters" group.
- 6.Parameter is cloned as part of the "Power Parameters" group.
- 7.Parameter is cloned as part of the "Drive Unique" group.
- 8.Parameter availability depends on the application selected.
- 9.Parameter is modified by an auto-tune.

Parameters Defined in the Firmware

PNO	Name	Path	Type	Default	Range	Units	WQ	View	Notes	Mbus
0001	Anin 01 Type	Setup::Inputs and Outputs::Base IO Parameters::Inputs And Outputs::IO Configure	USINT (enum)	0	0:-10..10 V 1:0..10 V 2:0..20 mA 3:4..20 mA		ALWAYS	OPERATOR		00529
0002	Anin 02 Type	Same as PNO 1	USINT (enum)	0	0:-10..10 V 1:0..10 V		ALWAYS	OPERATOR		00531
0003	Anout 01 Type	Same as PNO 1	USINT (enum)	0	0:-10..10 V 1:0..10 V 4:TORQUE OUT -10..10 V		ALWAYS	OPERATOR		00533
0004	Anout 02 Type	Same as PNO 1	USINT (enum)	1	1:0..10 V 2:0..20 mA 3:4..20 mA		ALWAYS	OPERATOR		00535
0005	Digin Value	Monitor::Inputs and Outputs Parameters::Inputs And Outputs::IO Values	WORD (bitfield)		0:Digin 01 1:Digin 02 2:Digin 03 3:Digin 04 4:Digin 05 5:Digin 06 6:Digin 07 7:STO Inactive 8:Digin 11 9:Digin 12 10:Digin 13 11:Digin 14 12:Run Key 13:Not Stop Key 14:Stop Key		NEVER	OPERATOR		00537
0006	Digin Value.Digin 01	Same as PNO 5	BOOL				NEVER	OPERATOR		00539
0007	Digin Value.Digin 02	Same as PNO 5	BOOL				NEVER	OPERATOR		00541
0008	Digin Value.Digin 03	Same as PNO 5	BOOL				NEVER	OPERATOR		00543
0009	Digin Value.Digin 04	Same as PNO 5	BOOL				NEVER	OPERATOR		00545
0010	Digin Value.Digin 05	Same as PNO 5	BOOL				NEVER	OPERATOR		00547
0011	Digin Value.Digin 06	Same as PNO 5	BOOL				NEVER	OPERATOR		00549
0012	Digin Value.Digin 07	Same as PNO 5	BOOL				NEVER	OPERATOR		00551
0013	Digin Value.STO Inactive	Same as PNO 5	BOOL				NEVER	OPERATOR		00553
0014	Digin Value.Digin 11	Same as PNO 5	BOOL				NEVER	OPERATOR		00555
0015	Digin Value.Digin 12	Same as PNO 5	BOOL				NEVER	OPERATOR		00557
0016	Digin Value.Digin 13	Same as PNO 5	BOOL				NEVER	OPERATOR		00559
0017	Digin Value.Digin 14	Same as PNO 5	BOOL				NEVER	OPERATOR		00561
0018	Digin Value.Run Key	Same as PNO 5	BOOL				NEVER	OPERATOR		00563
0019	Digin Value.Not Stop Key	Same as PNO 5	BOOL				NEVER	OPERATOR		00565
0020	Digin Value.Stop Key	Same as PNO 5	BOOL				NEVER	OPERATOR		00567
0022	Digout Value	Same as PNO 5	WORD (bitfield)	0000	0:Digout 01 1:Digout 02 2:Digout 03 3:Digout 04 4:Relay 01 5:Relay 02 8:Digout 11 9:Digout 12 10:Digout 13 11:Digout 14 14:Relay 11 15:Relay 12		ALWAYS	OPERATOR	2	00571
0023	Digout Value.Digout 01	Same as PNO 5	BOOL	FALSE			ALWAYS	OPERATOR	2	00573
0024	Digout Value.Digout 02	Same as PNO 5	BOOL	FALSE			ALWAYS	OPERATOR	2	00575
0025	Digout Value.Digout 03	Same as PNO 5	BOOL	FALSE			ALWAYS	OPERATOR	2	00577
0026	Digout Value.Digout 04	Same as PNO 5	BOOL	FALSE			ALWAYS	OPERATOR	2	00579
0027	Digout Value.Relay 01	Same as PNO 5	BOOL	FALSE			ALWAYS	OPERATOR	2	00581
0028	Digout Value.Relay 02	Same as PNO 5	BOOL	FALSE			ALWAYS	OPERATOR	2	00583
0031	Digout Value.Digout 11	Same as PNO 5	BOOL	FALSE			ALWAYS	OPERATOR	2	00589
0032	Digout Value.Digout 12	Same as PNO 5	BOOL	FALSE			ALWAYS	OPERATOR	2	00591
0033	Digout Value.Digout 13	Same as PNO 5	BOOL	FALSE			ALWAYS	OPERATOR	2	00593
0034	Digout Value.Digout 14	Same as PNO 5	BOOL	FALSE			ALWAYS	OPERATOR	2	00595
0037	Digout Value.Relay 11	Same as PNO 5	BOOL	FALSE			ALWAYS	OPERATOR	2	00601
0038	Digout Value.Relay 12	Monitor::Inputs and Outputs	BOOL	FALSE			ALWAYS	OPERATOR	2	00603

C-232 Parameter Reference

PNO	Name	Path	Type	Default	Range	Units	WQ	View	Notes	MBus
		Parameters::Inputs And Outputs::IO Values								
0039	Anin 01 Value	Same as PNO 38	REAL	x.x	-100.0 to 100.0	%	NEVER	OPERATOR		00605
0040	Anin 01 Break	Same as PNO 38	BOOL				NEVER	OPERATOR	4	00607
0041	Anin 02 Value	Same as PNO 38	REAL	x.x	-100.0 to 100.0	%	NEVER	OPERATOR		00609
0042	Anout 01 Value	Same as PNO 38	REAL	0.00	Min to Max	%	ALWAYS	OPERATOR	2	00611
0043	Anout 02 Value	Same as PNO 38	REAL	0.00	Min to Max	%	ALWAYS	OPERATOR	2	00613
0044	Comms Required	Setup::Communications::Option Parameters::Option Comms::Comms	USINT (enum)	1	1:NONE 2:BACNET IP 3:BACNET MSTP 4:CANOPEN 6:CONTROLNET 7:DEVICENET 8:ETHERCAT 9:ETHERNET IP 10:MODBUS RTU 11:MODBUS TCP 12:PROFIBUS DPV1 13:PROFINET IO 14:PASSIVE SERIAL 15:BC OPTION		CONFIG	TECHNICIAN		00615
0045	Comms Fitted	Monitor::Communications::Option Parameters::Option Comms::Comms	USINT (enum)		0:UNKNOWN 1:NONE 2:BACNET IP 3:BACNET MSTP 4:CANOPEN 5:CC LINK 6:CONTROLNET 7:DEVICENET 8:ETHERCAT 9:ETHERNET IP 10:MODBUS RTU 11:MODBUS TCP 12:PROFIBUS DPV1 13:PROFINET IO 14:PASSIVE SERIAL 15:BC OPTION 16:POWERLINK		NEVER	OPERATOR	1	00617
0046	Comms State	Parameters::Option Comms::Comms	USINT (enum)		0:SETUP 1:NW INIT 2:WAIT PROCESS 3:IDLE 4:PROCESS ACTIVE 5:ERROR 6:RESERVED 7:EXCEPTION 8:NONE		NEVER	ENGINEER	4	00619
0047	Comms Supervised	Same as PNO 45	BOOL				NEVER	OPERATOR	4	00621
0048	Comms Trip Enable	Same as PNO 44	BOOL	TRUE			ALWAYS	TECHNICIAN	4	00623
0049	Comms Module Version	Same as PNO 45	DWORD				NEVER	TECHNICIAN	4	00625
0050	Comms Module Serial	Same as PNO 45	DWORD				NEVER	TECHNICIAN	4	00627
0051	Comms Diagnostic	Same as PNO 45	USINT (enum)		0:OK 1:HARDWARE MISMATCH 2:INVALID CONFIGURATION 3:MAPPING FAILED 4:EXCEPTION 5:UNSUPPORTED OPTION		NEVER	OPERATOR		00629
0052	Comms Diagnostic Code	Same as PNO 45	DWORD				NEVER	OPERATOR	4	00631
0053	Comms Exception	Same as PNO 45	BYTE				NEVER	TECHNICIAN	4	00633
0054	Comms Net Exception	Same as PNO 45	BYTE				NEVER	TECHNICIAN	4	00635
0055	Read Mapping	Setup::Communications::Option Parameters::Option Comms::Read Process	ARRAY[0..31]				CONFIG	TECHNICIAN		00637
0056	Read Mapping[0]	Same as PNO 55	UINT	0627	0000 to 3145		CONFIG	TECHNICIAN	4	00639
0057	Read Mapping[1]	Same as PNO 55	UINT	0681	0000 to 3145		CONFIG	TECHNICIAN	4	00641
0058	Read Mapping[2]	Same as PNO 55	UINT	0000	0000 to 3145		CONFIG	TECHNICIAN	4	00643
0059	Read Mapping[3]	Same as PNO 55	UINT	0000	0000 to 3145		CONFIG	TECHNICIAN	4	00645
0060	Read Mapping[4]	Same as PNO 55	UINT	0000	0000 to 3145		CONFIG	TECHNICIAN	4	00647
0061	Read Mapping[5]	Same as PNO 55	UINT	0000	0000 to 3145		CONFIG	TECHNICIAN	4	00649
0062	Read Mapping[6]	Same as PNO 55	UINT	0000	0000 to 3145		CONFIG	TECHNICIAN	4	00651

Parameter Reference C-233

PNO	Name	Path	Type	Default	Range	Units	WQ	View	Notes	Mbus
0063	Read Mapping[7]	Same as PNO 55	UINT	0000	0000 to 3145		CONFIG	TECHNICIAN	4	00653
0064	Read Mapping[8]	Same as PNO 55	UINT	0000	0000 to 3145		CONFIG	TECHNICIAN	4	00655
0065	Read Mapping[9]	Same as PNO 55	UINT	0000	0000 to 3145		CONFIG	TECHNICIAN	4	00657
0066	Read Mapping[10]	Same as PNO 55	UINT	0000	0000 to 3145		CONFIG	TECHNICIAN	4	00659
0067	Read Mapping[11]	Same as PNO 55	UINT	0000	0000 to 3145		CONFIG	TECHNICIAN	4	00661
0068	Read Mapping[12]	Same as PNO 55	UINT	0000	0000 to 3145		CONFIG	TECHNICIAN	4	00663
0069	Read Mapping[13]	Same as PNO 55	UINT	0000	0000 to 3145		CONFIG	TECHNICIAN	4	00665
0070	Read Mapping[14]	Same as PNO 55	UINT	0000	0000 to 3145		CONFIG	TECHNICIAN	4	00667
0071	Read Mapping[15]	Same as PNO 55	UINT	0000	0000 to 3145		CONFIG	TECHNICIAN	4	00669
0072	Read Mapping[16]	Same as PNO 55	UINT	0000	0000 to 3145		CONFIG	TECHNICIAN	4	00671
0073	Read Mapping[17]	Same as PNO 55	UINT	0000	0000 to 3145		CONFIG	TECHNICIAN	4	00673
0074	Read Mapping[18]	Same as PNO 55	UINT	0000	0000 to 3145		CONFIG	TECHNICIAN	4	00675
0075	Read Mapping[19]	Same as PNO 55	UINT	0000	0000 to 3145		CONFIG	TECHNICIAN	4	00677
0076	Read Mapping[20]	Same as PNO 55	UINT	0000	0000 to 3145		CONFIG	TECHNICIAN	4	00679
0077	Read Mapping[21]	Same as PNO 55	UINT	0000	0000 to 3145		CONFIG	TECHNICIAN	4	00681
0078	Read Mapping[22]	Same as PNO 55	UINT	0000	0000 to 3145		CONFIG	TECHNICIAN	4	00683
0079	Read Mapping[23]	Same as PNO 55	UINT	0000	0000 to 3145		CONFIG	TECHNICIAN	4	00685
0080	Read Mapping[24]	Same as PNO 55	UINT	0000	0000 to 3145		CONFIG	TECHNICIAN	4	00687
0081	Read Mapping[25]	Same as PNO 55	UINT	0000	0000 to 3145		CONFIG	TECHNICIAN	4	00689
0082	Read Mapping[26]	Same as PNO 55	UINT	0000	0000 to 3145		CONFIG	TECHNICIAN	4	00691
0083	Read Mapping[27]	Same as PNO 55	UINT	0000	0000 to 3145		CONFIG	TECHNICIAN	4	00693
0084	Read Mapping[28]	Same as PNO 55	UINT	0000	0000 to 3145		CONFIG	TECHNICIAN	4	00695
0085	Read Mapping[29]	Same as PNO 55	UINT	0000	0000 to 3145		CONFIG	TECHNICIAN	4	00697
0086	Read Mapping[30]	Same as PNO 55	UINT	0000	0000 to 3145		CONFIG	TECHNICIAN	4	00699
0087	Read Mapping[31]	Same as PNO 55	UINT	0000	0000 to 3145		CONFIG	TECHNICIAN	4	00701
0113	Force Fan On	Parameters::Fan Control	BOOL	FALSE			ALWAYS	OPERATOR	2	00753
0114	Group IP Address	Setup::Communications::Peer to Peer Parameters::Base Comms::Peer to Peer	DWORD (IP addr)	000.000.000.000			ALWAYS	ENGINEER		00755
0115	Show Warnings 1 - 32	Parameters::Trips::Trips Status	DWORD	FFFFFFFF			ALWAYS	TECHNICIAN	4	00757
0116	Show Warnings 33 - 64	Parameters::Trips::Trips Status	DWORD	FFFFFFFF			ALWAYS	TECHNICIAN	4	00759
0117	Extended Support	Parameters::Device Manager::SD Card	BOOL	TRUE			ALWAYS	TECHNICIAN		00761
0118	Configuration Lock	Parameters::Application::App Info	BOOL	FALSE			ALWAYS	TECHNICIAN		00763
0119	DC Link Volts Trim	Parameters::Motor Control::Feedbacks	REAL	0	-20 to 20	V	ALWAYS	TECHNICIAN		00765
0120	Write Mapping	Setup::Communications::Option Parameters::Option Comms::Write Process	ARRAY[0..31]				CONFIG	TECHNICIAN		00767
0121	Write Mapping[0]	Same as PNO 120	UINT	0661	0000 to 3145		CONFIG	TECHNICIAN	4	00769
0122	Write Mapping[1]	Same as PNO 120	UINT	0395	0000 to 3145		CONFIG	TECHNICIAN	4	00771
0123	Write Mapping[2]	Same as PNO 120	UINT	0000	0000 to 3145		CONFIG	TECHNICIAN	4	00773
0124	Write Mapping[3]	Same as PNO 120	UINT	0000	0000 to 3145		CONFIG	TECHNICIAN	4	00775
0125	Write Mapping[4]	Same as PNO 120	UINT	0000	0000 to 3145		CONFIG	TECHNICIAN	4	00777
0126	Write Mapping[5]	Same as PNO 120	UINT	0000	0000 to 3145		CONFIG	TECHNICIAN	4	00779
0127	Write Mapping[6]	Same as PNO 120	UINT	0000	0000 to 3145		CONFIG	TECHNICIAN	4	00781
0128	Write Mapping[7]	Same as PNO 120	UINT	0000	0000 to 3145		CONFIG	TECHNICIAN	4	00783
0129	Write Mapping[8]	Same as PNO 120	UINT	0000	0000 to 3145		CONFIG	TECHNICIAN	4	00785
0130	Write Mapping[9]	Same as PNO 120	UINT	0000	0000 to 3145		CONFIG	TECHNICIAN	4	00787
0131	Write Mapping[10]	Same as PNO 120	UINT	0000	0000 to 3145		CONFIG	TECHNICIAN	4	00789
0132	Write Mapping[11]	Same as PNO 120	UINT	0000	0000 to 3145		CONFIG	TECHNICIAN	4	00791
0133	Write Mapping[12]	Same as PNO 120	UINT	0000	0000 to 3145		CONFIG	TECHNICIAN	4	00793
0134	Write Mapping[13]	Same as PNO 120	UINT	0000	0000 to 3145		CONFIG	TECHNICIAN	4	00795
0135	Write Mapping[14]	Same as PNO 120	UINT	0000	0000 to 3145		CONFIG	TECHNICIAN	4	00797
0136	Write Mapping[15]	Same as PNO 120	UINT	0000	0000 to 3145		CONFIG	TECHNICIAN	4	00799
0137	Write Mapping[16]	Same as PNO 120	UINT	0000	0000 to 3145		CONFIG	TECHNICIAN	4	00801
0138	Write Mapping[17]	Same as PNO 120	UINT	0000	0000 to 3145		CONFIG	TECHNICIAN	4	00803
0139	Write Mapping[18]	Same as PNO 120	UINT	0000	0000 to 3145		CONFIG	TECHNICIAN	4	00805
0140	Write Mapping[19]	Same as PNO 120	UINT	0000	0000 to 3145		CONFIG	TECHNICIAN	4	00807
0141	Write Mapping[20]	Same as PNO 120	UINT	0000	0000 to 3145		CONFIG	TECHNICIAN	4	00809
0142	Write Mapping[21]	Same as PNO 120	UINT	0000	0000 to 3145		CONFIG	TECHNICIAN	4	00811
0143	Write Mapping[22]	Same as PNO 120	UINT	0000	0000 to 3145		CONFIG	TECHNICIAN	4	00813
0144	Write Mapping[23]	Same as PNO 120	UINT	0000	0000 to 3145		CONFIG	TECHNICIAN	4	00815
0145	Write Mapping[24]	Same as PNO 120	UINT	0000	0000 to 3145		CONFIG	TECHNICIAN	4	00817
0146	Write Mapping[25]	Same as PNO 120	UINT	0000	0000 to 3145		CONFIG	TECHNICIAN	4	00819
0147	Write Mapping[26]	Same as PNO 120	UINT	0000	0000 to 3145		CONFIG	TECHNICIAN	4	00821
0148	Write Mapping[27]	Same as PNO 120	UINT	0000	0000 to 3145		CONFIG	TECHNICIAN	4	00823
0149	Write Mapping[28]	Same as PNO 120	UINT	0000	0000 to 3145		CONFIG	TECHNICIAN	4	00825
0150	Write Mapping[29]	Same as PNO 120	UINT	0000	0000 to 3145		CONFIG	TECHNICIAN	4	00827
0151	Write Mapping[30]	Same as PNO 120	UINT	0000	0000 to 3145		CONFIG	TECHNICIAN	4	00829

C-234 Parameter Reference

PNO	Name	Path	Type	Default	Range	Units	WQ	View	Notes	Mbus
0152	Write Mapping[31]	Same as PNO 120	UINT	0000	0000 to 3145		CONFIG	TECHNICIAN	4	00831
0182	Backup Action	Parameters::Device Manager::Parameter Backup	USINT (enum)	0	0:SAVE 1:LOAD ALL 2:LOAD POWER 3:LOAD OTHER 4:LOAD AUTOTUNE		ALWAYS	OPERATOR	2	00891
0183	Backup-Restore Start	Parameters::Device Manager::Parameter Backup	BOOL	FALSE			ALWAYS	OPERATOR	2	00893
0184	Backup-Restore Status	Parameters::Device Manager::Parameter Backup	USINT (enum)		0:IDLE 1:SAVING 2:RESTORING 3:VERIFYING 4:DONE 6:FAILED 8:VERIFY FAILED		NEVER	OPERATOR		00895
0185	Comms Event Code	Parameters::Option Comms::Event	BYTE	00			ALWAYS	ENGINEER	2,4	00897
0186	Comms Event Active	Monitor::Communications::Option Parameters::Option Comms::Event	BOOL				NEVER	OPERATOR	4	00899
0187	Comms Event Set	Parameters::Option Comms::Event	BOOL	FALSE			ALWAYS	ENGINEER	2,4	00901
0188	Comms Event Clear	Parameters::Option Comms::Event	BOOL	FALSE			ALWAYS	ENGINEER	2,4	00903
0189	Option MAC Address	Monitor::Communications::Option Parameters::Option Comms::Option Ethernet	STRING[18]				NEVER	TECHNICIAN	4	00905
0195	Option IP Address	Same as PNO 189	DWORD (IP addr)				NEVER	OPERATOR	4	00917
0196	Option Subnet Mask	Same as PNO 189	DWORD (IP addr)				NEVER	OPERATOR	4	00919
0197	Option Gateway	Same as PNO 189	DWORD (IP addr)				NEVER	OPERATOR	4	00921
0198	Option DHCP Enabled	Same as PNO 189	BOOL				NEVER	TECHNICIAN	4	00923
0199	Address Assignment	Setup::Communications::Option Parameters::Option Comms::Option Ethernet	USINT (enum)	0	0:FIXED 1:EXTERNAL 2:DHCP		CONFIG	TECHNICIAN	4	00925
0200	Fixed IP Address	Same as PNO 199	DWORD (IP addr)	000.000.000.000			CONFIG	TECHNICIAN	7,4	00927
0201	Fixed Subnet Mask	Same as PNO 199	DWORD (IP addr)	000.000.000.000			CONFIG	TECHNICIAN	7,4	00929
0202	Fixed Gateway Address	Same as PNO 199	DWORD (IP addr)	000.000.000.000			CONFIG	TECHNICIAN	7,4	00931
0203	Option Web Enable	Same as PNO 199	BOOL	TRUE			CONFIG	TECHNICIAN	4	00933
0204	Web Parameters Enable	Same as PNO 199	BOOL	TRUE			CONFIG	TECHNICIAN	4	00935
0205	Option FTP Enable	Same as PNO 199	BOOL	TRUE			CONFIG	ENGINEER	4	00937
0206	Option FTP Admin Mode	Same as PNO 199	BOOL	TRUE			CONFIG	ENGINEER	4	00939
0207	IPConfig Enable	Same as PNO 199	BOOL	TRUE			CONFIG	ENGINEER	4	00941
0208	BACnet IP State	Monitor::Communications::Option Parameters::Option Comms::BACnet IP	USINT (enum)		Same as PNO 46		NEVER	OPERATOR	4	00943
0209	BACnet IP Device ID	Setup::Communications::Option Parameters::Option Comms::BACnet IP	UDINT	0	0 to 4194302		CONFIG	TECHNICIAN	7,4	00945
0210	BACnet IP Timeout	Same as PNO 209	TIME	3.000	0.000 to 65.000	s	CONFIG	TECHNICIAN	4	00947
0211	CANopen State	Monitor::Communications::Option Parameters::Option Comms::CANopen	USINT (enum)		0:SETUP 1:NW INIT 2:PRE-OPERATIONAL 3:STOP 4:OPERATIONAL 5:BUS OFF 6:RESERVED 7:EXCEPTION 8:NONE		NEVER	OPERATOR	4	00949
0212	CANopen Node Address	Setup::Communications::Option Parameters::Option Comms::CANopen	USINT	1	1 to 127		CONFIG	TECHNICIAN	7,4	00951
0213	CANopen Baud Rate	Same as PNO 212	USINT (enum)	9	0:10 KBPS 1:20 KBPS 2:50 KBPS 3:100 KBPS 4:125 KBPS 5:250 KBPS 6:500 KBPS 7:800 KBPS 8:1000 KBPS		CONFIG	TECHNICIAN	4	00953

Parameter Reference C-235

PNO	Name	Path	Type	Default	Range	Units	WQ	View	Notes	Mbus
0214	ControlNet State	Monitor::Communications::Option Parameters::Option Comms::ControlNet	USINT (enum)		9:AUTO 0:SETUP 1:NW INIT 2:WAITING TO CONNECT 3:CONNECTION IDLE 4:CONNECTION ACTIVE 5:ERROR 6:RESERVED 7:EXCEPTION 8:NONE		NEVER	OPERATOR	4	00955
0215	ControlNet MAC ID	Setup::Communications::Option Parameters::Option Comms::ControlNet	USINT	0	0 to 99		CONFIG	TECHNICIAN	7,4	00957
0216	CNet Producing Inst	Same as PNO 215	WORD	0064			CONFIG	TECHNICIAN	4	00959
0217	CNet Consuming Inst	Same as PNO 215	WORD	0096			CONFIG	TECHNICIAN	4	00961
0218	DeviceNet State	Monitor::Communications::Option Parameters::Option Comms::DeviceNet	USINT (enum)		Same as PNO 214		NEVER	OPERATOR	4	00963
0219	DeviceNet MAC ID	Setup::Communications::Option Parameters::Option Comms::DeviceNet	USINT	0	0 to 63		CONFIG	TECHNICIAN	7,4	00965
0220	DeviceNet Baud Rate	Same as PNO 219	USINT (enum)	3	0:125 KBPS 1:250 KBPS 2:500 KBPS 3:AUTO		CONFIG	TECHNICIAN	4	00967
0221	DeviceNet Actual Baud	Same as PNO 218	USINT (enum)		Same as PNO 220		NEVER	OPERATOR	4	00969
0222	DNet Producing Inst	Same as PNO 219	WORD	0064			CONFIG	TECHNICIAN	4	00971
0223	DNet Consuming Inst	Same as PNO 219	WORD	0096			CONFIG	TECHNICIAN	4	00973
0224	EtherCAT State	Monitor::Communications::Option Parameters::Option Comms::EtherCAT	USINT (enum)		0:SETUP 1:NW INIT 2:INIT OR PREOP 3:SAFE OPERATIONAL 4:OPERATIONAL 5:ERROR 6:RESERVED 7:EXCEPTION 8:NONE		NEVER	OPERATOR	4	00975
0225	EtherNet IP State	Monitor::Communications::Option Parameters::Option Comms::EtherNet IP	USINT (enum)		Same as PNO 214		NEVER	OPERATOR	4	00977
0226	ENet Producing Inst	Setup::Communications::Option Parameters::Option Comms::EtherNet IP	WORD	0064			CONFIG	TECHNICIAN	4	00979
0227	ENet Consuming Inst	Same as PNO 226	WORD	0096			CONFIG	TECHNICIAN	4	00981
0228	Modbus RTU State	Monitor::Communications::Option Parameters::Option Comms::Modbus RTU	USINT (enum)		Same as PNO 46		NEVER	OPERATOR	4	00983
0229	Modbus Device Address	Setup::Communications::Option Parameters::Option Comms::Modbus RTU	USINT	1	1 to 247		CONFIG	TECHNICIAN	7,4	00985
0230	Modbus RTU Baud Rate	Same as PNO 229	USINT (enum)	4	0:1200 BPS 1:2400 BPS 2:4800 BPS 3:9600 BPS 4:19200 BPS 5:38400 BPS 6:57600 BPS 7:76800 BPS 8:115200 BPS		CONFIG	TECHNICIAN	4	00987
0231	Parity And Stop Bits	Same as PNO 229	USINT (enum)	0	0:EVEN, 1 STOP 1:ODD, 1 STOP 2:NONE, 2 STOP 3:NONE, 1 STOP		CONFIG	TECHNICIAN	4	00989
0232	High Word First RTU	Same as PNO 229	BOOL	FALSE			CONFIG	TECHNICIAN	4	00991
0233	Modbus RTU Timeout	Same as PNO 229	TIME	3.000	0.000 to 65.000	s	CONFIG	TECHNICIAN	4	00993
0234	Modbus TCP State	Monitor::Communications::Option Parameters::Option Comms::Modbus TCP	USINT (enum)		Same as PNO 46		NEVER	OPERATOR	4	00995
0235	High Word First TCP	Setup::Communications::Option Parameters::Option Comms::Modbus TCP	BOOL	FALSE			CONFIG	TECHNICIAN	4	00997
0236	Modbus TCP Timeout	Same as PNO 235	TIME	3.000	0.000 to 65.000	s	CONFIG	TECHNICIAN	4	00999
0237	Profibus State	Monitor::Communications::Option Parameters::Option Comms::Profibus	USINT (enum)		Same as PNO 46		NEVER	OPERATOR	4	01001
0238	Profibus Node Address	Setup::Communications::Option Parameters::Option Comms::Profibus	USINT	0	0 to 126		CONFIG	TECHNICIAN	7,4	01003

C-236 Parameter Reference

PNO	Name	Path	Type	Default	Range	Units	WQ	View	Notes	Mbus
0239	PROFINET State	Monitor::Communications::Option Parameters::Option Comms::PROFINET IO	USINT (enum)		0:SETUP 1:NW INIT 2:WAITING TO CONNECT 3:STOP MODE 4:CONNECTED 5:ERROR 6:RESERVED 7:EXCEPTION 8:NONE		NEVER	OPERATOR	4	01005
0240	PROFINET Device Name	Same as PNO 239	STRING[32]				NEVER	OPERATOR	4	01007
0249	Braking Enable	Parameters::Motor Control::Braking	BOOL	TRUE			ALWAYS	TECHNICIAN	6	01025
0251	Brake Resistance	Parameters::Motor Control::Braking	REAL	100.00	0.01 to 1000.00	Ohm	STOPPED	TECHNICIAN	6	01029
0252	Brake Rated Power	Parameters::Motor Control::Braking	REAL	0.11	0.10 to 510.00	kW	STOPPED	TECHNICIAN	6	01031
0253	Brake Overrating	Parameters::Motor Control::Braking	REAL	25.00	1.00 to 40.00		STOPPED	ENGINEER	6	01033
0254	Braking Active	Parameters::Motor Control::Braking	BOOL				NEVER	TECHNICIAN		01035
0255	Autotune Enable	Setup::Motor Control::Autotune Parameters::Motor Control::Autotune	BOOL	FALSE			STOPPED	TECHNICIAN	2,4	01037
0256	Autotune Mode	Same as PNO 255	USINT (enum)	1	0:STATIONARY 1:ROTATING		STOPPED	TECHNICIAN	6,4	01039
0257	Autotune Test Disable	Same as PNO 255	WORD (bitfield)	0000	0:Stator Resistance 1:Leakage Inductance 2:Magnetising Current 3:Rotor Time Constant 4:Encoder Direction		STOPPED	TECHNICIAN	6,4	01041
0258	Autotune Test Disable.Stator Resistance	Same as PNO 255	BOOL	FALSE			STOPPED	TECHNICIAN	6,4	01043
0259	Autotune Test Disable.Leakage Inductance	Same as PNO 255	BOOL	FALSE			STOPPED	TECHNICIAN	6,4	01045
0260	Autotune Test Disable.Magnetising Current	Same as PNO 255	BOOL	FALSE			STOPPED	TECHNICIAN	6,4	01047
0261	Autotune Test Disable.Rotor Time Constant	Same as PNO 255	BOOL	FALSE			STOPPED	TECHNICIAN	6,4	01049
0262	Autotune Test Disable.Encoder Direction	Same as PNO 255	BOOL	FALSE			STOPPED	TECHNICIAN	6,4	01051
0274	Autotune Ramp Time	Same as PNO 255	TIME	10.000	1.000 to 1000.000	s	STOPPED	TECHNICIAN	6,4	01075
0286	MRAS Speed Percent	Parameters::Motor Control::MRAS	REAL	x.xx	Min to Max	%	NEVER	ENGINEER	4	01099
0287	MRAS Speed RPM	Parameters::Motor Control::MRAS	REAL	x.xx	Min to Max	RPM	NEVER	ENGINEER	4	01101
0289	MRAS Field Frequency	Parameters::Motor Control::MRAS	REAL	x.xx	Min to Max	Hz	NEVER	ENGINEER	4	01105
0290	MRAS Torque Percent	Parameters::Motor Control::MRAS	REAL	x.xx	Min to Max	%	NEVER	ENGINEER	4	01107
0291	MRAS Torque	Parameters::Motor Control::MRAS	REAL	x.xx	Min to Max	Nm	NEVER	ENGINEER	4	01109
0305	Current Limit	Setup::Motor Control::Control and Type Parameters::Motor Control::Current Limit	REAL	150.0	0.0 to 600.0	%	ALWAYS	TECHNICIAN		01137
0307	Regen Limit Enable	Parameters::Motor Control::Current Limit	BOOL	TRUE			ALWAYS	ENGINEER	4	01141
0310	VHz Flying Start Enable	Parameters::Motor Control::Flycatching	BOOL	FALSE			ALWAYS	TECHNICIAN	4	01147
0311	VC Flying Start Enable	Parameters::Motor Control::Flycatching	BOOL	FALSE			ALWAYS	TECHNICIAN	4	01149
0312	Flying Start Mode	Parameters::Motor Control::Flycatching	USINT (enum)	0	0:ALWAYS 1:TRIP OR POWER UP 2:TRIP		ALWAYS	TECHNICIAN	4	01151
0313	Search Mode	Parameters::Motor Control::Flycatching	USINT (enum)	0	0:BIDIRECTIONAL 1:UNIDIRECTION		ALWAYS	TECHNICIAN	4	01153
0314	Search Volts	Parameters::Motor Control::Flycatching	REAL	9.0	0.0 to 100.0	%	ALWAYS	TECHNICIAN	6,4	01155
0315	Search Boost	Parameters::Motor Control::Flycatching	REAL	40.0	0.0 to 50.0	%	ALWAYS	TECHNICIAN	6,4	01157
0316	Search Time	Parameters::Motor Control::Flycatching	TIME	5.000	0.100 to 60.000	s	ALWAYS	TECHNICIAN	6,4	01159
0317	Min Search Speed	Parameters::Motor Control::Flycatching	REAL	5	0 to 500	Hz	ALWAYS	TECHNICIAN	4	01161
0318	Flying Reflux Time	Parameters::Motor Control::Flycatching	TIME	3.000	0.100 to 10.000	s	ALWAYS	TECHNICIAN	6,4	01163
0324	DC Inj Deflux Time	Parameters::Motor Control::Inj Braking	TIME	0.500	0.100 to 20.000	s	ALWAYS	TECHNICIAN	6,4	01175
0325	DC Inj Frequency	Parameters::Motor Control::Inj Braking	REAL	9	1 to 500	Hz	ALWAYS	TECHNICIAN	6,4	01177
0326	DC Inj Current Limit	Parameters::Motor Control::Inj Braking	REAL	100.0	50.0 to 150.0	%	ALWAYS	TECHNICIAN	6,4	01179
0327	DC Pulse Time	Parameters::Motor Control::Inj Braking	TIME	2.000	0.000 to 100.000	s	ALWAYS	TECHNICIAN	6,4	01181
0328	Final DC Pulse Time	Parameters::Motor Control::Inj Braking	TIME	1.000	0.000 to 10.000	s	ALWAYS	TECHNICIAN	6,4	01183
0329	DC Current Level	Parameters::Motor Control::Inj Braking	REAL	3.0	0.0 to 25.0	%	ALWAYS	TECHNICIAN	6,4	01185
0330	DC Inj Timeout	Parameters::Motor Control::Inj Braking	TIME	90.000	0.000 to 600.000	s	ALWAYS	TECHNICIAN	6,4	01187
0331	DC Inj Base Volts	Parameters::Motor Control::Inj Braking	REAL	100.00	0.00 to 115.47	%	ALWAYS	TECHNICIAN	6,4	01189
0332	100% Mot Current	Parameters::Motor Control::Motor Load	REAL	x.x	0.0 to 10000.0		NEVER	TECHNICIAN		01191
0333	Mot Inv Time Overload	Parameters::Motor Control::Motor Load	REAL	x.	0 to 500	%	NEVER	TECHNICIAN	4	01193
0334	Mot Inv Time Delay	Parameters::Motor Control::Motor Load	TIME	60.000	6.000 to 60.000	s	ALWAYS	TECHNICIAN	6,4	01195
0335	Mot Inv Time Warning	Parameters::Motor Control::Motor Load	BOOL				NEVER	TECHNICIAN	4	01197
0336	Mot Inv Time Active	Parameters::Motor Control::Motor Load	BOOL				NEVER	TECHNICIAN	4	01199
0337	Mot Inv Time Output %	Parameters::Motor Control::Motor Load	REAL	x.x	0.0 to 600.0	%	NEVER	TECHNICIAN	4	01201
0338	Mot I2T TC	Parameters::Motor Control::Motor Load	TIME		0.000 to 1000000.000	s	NEVER	TECHNICIAN	4	01203
0339	Actual Mot I2T Output	Parameters::Motor Control::Motor Load	REAL	x.x	0.0 to 600.0	%	NEVER	TECHNICIAN	4	01205
0340	Mot I2T Active	Parameters::Motor Control::Motor Load	BOOL				NEVER	OPERATOR	4	01207

Parameter Reference C-237

PNO	Name	Path	Type	Default	Range	Units	WQ	View	Notes	Mbus
0341	Mot I2T Warning	Parameters::Motor Control::Motor Load	BOOL				NEVER	TECHNICIAN	4	01209
0342	Mot I2T Enable	Parameters::Motor Control::Motor Load	BOOL				NEVER	TECHNICIAN	4	01211
0343	100% Stk Current	Parameters::Motor Control::Stack Inv Time	REAL	x.x	0.0 to 10000.0	A	NEVER	TECHNICIAN		01213
0344	Long Overload Level	Parameters::Motor Control::Stack Inv Time	REAL	x.	0 to 200	%	NEVER	TECHNICIAN		01215
0345	Long Overload Time	Parameters::Motor Control::Stack Inv Time	TIME		0.000 to 100000.000	s	NEVER	TECHNICIAN		01217
0346	Short Overload Level	Parameters::Motor Control::Stack Inv Time	REAL	x.	0 to 200	%	NEVER	TECHNICIAN		01219
0347	Short Overload Time	Parameters::Motor Control::Stack Inv Time	TIME		0.000 to 10000.000	s	NEVER	TECHNICIAN		01221
0348	Inv Time Aiming Point	Parameters::Motor Control::Stack Inv Time	REAL	105.00	0.00 to 125.00	%	ALWAYS	TECHNICIAN	6	01223
0349	Inv Time Output	Parameters::Motor Control::Stack Inv Time	REAL	x.	0 to 600	%	NEVER	TECHNICIAN		01225
0350	Inv Time Up Rate	Parameters::Motor Control::Stack Inv Time	TIME	5.000	0.000 to 120.000	s	STOPPED	ENGINEER	6	01227
0351	Inv Time Down Rate	Parameters::Motor Control::Stack Inv Time	TIME	5.000	0.000 to 120.000	s	STOPPED	ENGINEER	6	01229
0352	Inv Time Warning	Parameters::Motor Control::Stack Inv Time	BOOL				NEVER	TECHNICIAN		01231
0353	Inv Time Active	Parameters::Motor Control::Stack Inv Time	BOOL				NEVER	TECHNICIAN		01233
0354	Slip Compensatn Enable	Parameters::Motor Control::Slip Compensation	BOOL	FALSE			ALWAYS	TECHNICIAN	4	01235
0356	SLP Motoring Limit	Parameters::Motor Control::Slip Compensation	REAL	150	0 to 600	RPM	ALWAYS	TECHNICIAN	6,4	01239
0357	SLP Regen Limit	Parameters::Motor Control::Slip Compensation	REAL	150	0 to 600	RPM	ALWAYS	TECHNICIAN	6,4	01241
0360	Slew Rate Enable	Parameters::Motor Control::Slew Rate	BOOL	TRUE			ALWAYS	TECHNICIAN		01247
0361	Slew Rate Accel Limit	Parameters::Motor Control::Slew Rate	REAL	500	1 to 1200	Hz/s	ALWAYS	TECHNICIAN		01249
0362	Slew Rate Decel Limit	Parameters::Motor Control::Slew Rate	REAL	500	1 to 1200	Hz/s	ALWAYS	TECHNICIAN		01251
0364	Stabilisation Enable	Parameters::Motor Control::Stabilisation	BOOL	TRUE			ALWAYS	TECHNICIAN	4	01255
0371	Terminal Voltage Mode	Parameters::Motor Control::Voltage Control	USINT (enum)	0	0:NONE 1:FIXED 2:AUTOMATIC		ALWAYS	TECHNICIAN	4	01269
0374	Motor Base Volts	Parameters::Motor Control::Voltage Control	REAL	100.00	0.00 to 115.47	%	ALWAYS	TECHNICIAN	4	01275
0380	Power kW	Monitor::Energy Meter Parameters::Motor Control::Energy Meter	REAL	x.xx	0.00 to 1000000.00	kW	NEVER	TECHNICIAN		01287
0381	Power HP	Same as PNO 380	REAL	x.xx	0.00 to 1000000.00	HP	NEVER	TECHNICIAN		01289
0382	Reactive Power	Same as PNO 380	REAL	x.xx	0.00 to 1000000.00	kVAr	NEVER	TECHNICIAN		01291
0383	Energy kWh	Same as PNO 380	REAL	x.xx	0.00 to 10000000.00	kWh	NEVER	TECHNICIAN	1	01293
0385	Power Factor Est	Same as PNO 380	REAL	x.xx	0.00 to 1.00		NEVER	TECHNICIAN		01297
0386	Power Factor Angle Est	Parameters::Motor Control::Energy Meter	REAL	x.xx	0.00 to 90.00	deg	NEVER	TECHNICIAN		01299
0389	Reset Energy Meter	Parameters::Motor Control::Energy Meter	BOOL	FALSE			ALWAYS	TECHNICIAN	2	01305
0390	Duty Selection	Setup::Motor Control::Control and Type Parameters::Motor Control::Feedbacks	USINT (enum)	1	0:HEAVY DUTY 1:NORMAL DUTY		STOPPED	TECHNICIAN		01307
0392	DC Link Voltage	Monitor::Motor and Drive Monitor::Regen Control Parameters::Motor Control::Feedbacks	REAL	x.	0 to 1000	V	NEVER	TECHNICIAN		01311
0393	Actual Speed RPM	Monitor::Motor and Drive Parameters::Motor Control::Feedbacks	REAL	x.xx	-100000.00 to 100000.00	RPM	NEVER	TECHNICIAN		01313
0394	Actual Speed rps	Same as PNO 393	REAL	x.xx	-1500.00 to 1500.00	rev/s	NEVER	TECHNICIAN		01315
0395	Actual Speed Percent	Same as PNO 393	REAL	x.xx	-200.00 to 200.00	%	NEVER	OPERATOR		01317
0396	DC Link Volt Filtered	Same as PNO 393	REAL	x.	0 to 1000	V	NEVER	TECHNICIAN		01319
0397	id	Parameters::Motor Control::Feedbacks	REAL	x.x	-600.0 to 600.0	%	NEVER	TECHNICIAN		01321
0398	iq	Parameters::Motor Control::Feedbacks	REAL	x.x	-600.0 to 600.0	%	NEVER	TECHNICIAN		01323
0399	Actual Torque	Same as PNO 393	REAL	x.x	-600.0 to 600.0	%	NEVER	TECHNICIAN		01325
0400	Actual Field Current	Same as PNO 393	REAL	x.x	-200.0 to 200.0	%	NEVER	TECHNICIAN		01327
0401	Motor Current Percent	Same as PNO 393	REAL	x.x	0.0 to 600.0	%	NEVER	TECHNICIAN		01329
0402	Motor Current	Same as PNO 393	REAL	x.x	0.0 to 2000.0	A	NEVER	TECHNICIAN		01331
0403	100% Stack Current A	Parameters::Motor Control::Feedbacks	REAL	x.x	0.0 to 2000.0	A	NEVER	TECHNICIAN		01333
0404	Stack Current (%)	Parameters::Motor Control::Feedbacks	REAL	x.	0 to 500	%	NEVER	TECHNICIAN		01335
0405	Motor Terminal Volts	Same as PNO 393	REAL	x.	0 to 1000	V	NEVER	TECHNICIAN		01337
0406	CM Temperature	Same as PNO 393	REAL	x.x	-25.0 to 200.0	°C	NEVER	TECHNICIAN		01339
0407	Heatsink Temperature	Same as PNO 393	REAL	x.x	-25.0 to 200.0	°C	NEVER	TECHNICIAN		01341
0408	Elec Rotor Speed	Parameters::Motor Control::Feedbacks	REAL	x.x	-1500.0 to 1500.0	Hz	NEVER	OPERATOR		01343
0410	Archive Flags	Parameters::Application::App Info	WORD				NEVER	OPERATOR		01347
0412	Stack Frequency	Parameters::Motor Control::Pattern Generator	REAL	4.00	2.00 to 16.00	kHz	ALWAYS	ENGINEER	6	01351
0413	Random Pattern IM	Parameters::Motor Control::Pattern Generator	BOOL	TRUE			ALWAYS	ENGINEER	4	01353
0414	Deflux Delay	Parameters::Motor Control::Pattern Generator	TIME	1.000	0.000 to 60.000	s	STOPPED	ENGINEER	6	01355
0415	Positive Torque Lim	Parameters::Motor Control::Torque Limit	REAL	150.0	-600.0 to 600.0	%	ALWAYS	TECHNICIAN		01357
0416	Negative Torque Lim	Parameters::Motor Control::Torque Limit	REAL	-150.0	-600.0 to 600.0	%	ALWAYS	TECHNICIAN		01359
0417	Main Torque Lim	Setup::Motor Control::Control and Type Parameters::Motor Control::Torque Limit	REAL	150.0	0.0 to 600.0	%	ALWAYS	TECHNICIAN		01361
0418	Fast Stop Torque Lim	Parameters::Motor Control::Torque Limit	REAL	150.0	0.0 to 600.0	%	ALWAYS	TECHNICIAN		01363
0419	Symmetric Torque Lim	Parameters::Motor Control::Torque Limit	BOOL	FALSE			ALWAYS	TECHNICIAN		01365
0420	Actual Pos Torque Lim	Monitor::Motor and Drive Parameters::Motor Control::Torque Limit	REAL	x.x	-600.0 to 600.0	%	NEVER	TECHNICIAN		01367

C-238 Parameter Reference

PNO	Name	Path	Type	Default	Range	Units	WQ	View	Notes	Mbus
0421	Actual Neg Torque Lim	Same as PNO 420	REAL	x.x	-600.0 to 600.0	%	NEVER	TECHNICIAN		01369
0422	VHz Shape	Setup::Motor Control::Control and Type Parameters::Motor Control::Fluxing VHz	USINT (enum)	0	0:LINEAR LAW 1:FAN LAW 2:USER DEFINED 3:APPLICATION DEFINED		STOPPED	TECHNICIAN	4	01371
0423	VHz User Freq	Parameters::Motor Control::Fluxing VHz	ARRAY[0..10]				STOPPED	ENGINEER		01373
0424	VHz User Freq[0]	Parameters::Motor Control::Fluxing VHz	REAL	0.0	0.0 to 100.0	%	STOPPED	ENGINEER	4	01375
0425	VHz User Freq[1]	Parameters::Motor Control::Fluxing VHz	REAL	10.0	0.0 to 100.0	%	STOPPED	ENGINEER	4	01377
0426	VHz User Freq[2]	Parameters::Motor Control::Fluxing VHz	REAL	20.0	0.0 to 100.0	%	STOPPED	ENGINEER	4	01379
0427	VHz User Freq[3]	Parameters::Motor Control::Fluxing VHz	REAL	30.0	0.0 to 100.0	%	STOPPED	ENGINEER	4	01381
0428	VHz User Freq[4]	Parameters::Motor Control::Fluxing VHz	REAL	40.0	0.0 to 100.0	%	STOPPED	ENGINEER	4	01383
0429	VHz User Freq[5]	Parameters::Motor Control::Fluxing VHz	REAL	50.0	0.0 to 100.0	%	STOPPED	ENGINEER	4	01385
0430	VHz User Freq[6]	Parameters::Motor Control::Fluxing VHz	REAL	60.0	0.0 to 100.0	%	STOPPED	ENGINEER	4	01387
0431	VHz User Freq[7]	Parameters::Motor Control::Fluxing VHz	REAL	70.0	0.0 to 100.0	%	STOPPED	ENGINEER	4	01389
0432	VHz User Freq[8]	Parameters::Motor Control::Fluxing VHz	REAL	80.0	0.0 to 100.0	%	STOPPED	ENGINEER	4	01391
0433	VHz User Freq[9]	Parameters::Motor Control::Fluxing VHz	REAL	90.0	0.0 to 100.0	%	STOPPED	ENGINEER	4	01393
0434	VHz User Freq[10]	Parameters::Motor Control::Fluxing VHz	REAL	100.0	0.0 to 100.0	%	STOPPED	ENGINEER	4	01395
0435	VHz User Volts	Parameters::Motor Control::Fluxing VHz	ARRAY[0..10]				STOPPED	ENGINEER		01397
0436	VHz User Volts[0]	Parameters::Motor Control::Fluxing VHz	REAL	0.0	0.0 to 100.0	%	STOPPED	ENGINEER	4	01399
0437	VHz User Volts[1]	Parameters::Motor Control::Fluxing VHz	REAL	10.0	0.0 to 100.0	%	STOPPED	ENGINEER	4	01401
0438	VHz User Volts[2]	Parameters::Motor Control::Fluxing VHz	REAL	20.0	0.0 to 100.0	%	STOPPED	ENGINEER	4	01403
0439	VHz User Volts[3]	Parameters::Motor Control::Fluxing VHz	REAL	30.0	0.0 to 100.0	%	STOPPED	ENGINEER	4	01405
0440	VHz User Volts[4]	Parameters::Motor Control::Fluxing VHz	REAL	40.0	0.0 to 100.0	%	STOPPED	ENGINEER	4	01407
0441	VHz User Volts[5]	Parameters::Motor Control::Fluxing VHz	REAL	50.0	0.0 to 100.0	%	STOPPED	ENGINEER	4	01409
0442	VHz User Volts[6]	Parameters::Motor Control::Fluxing VHz	REAL	60.0	0.0 to 100.0	%	STOPPED	ENGINEER	4	01411
0443	VHz User Volts[7]	Parameters::Motor Control::Fluxing VHz	REAL	70.0	0.0 to 100.0	%	STOPPED	ENGINEER	4	01413
0444	VHz User Volts[8]	Parameters::Motor Control::Fluxing VHz	REAL	80.0	0.0 to 100.0	%	STOPPED	ENGINEER	4	01415
0445	VHz User Volts[9]	Parameters::Motor Control::Fluxing VHz	REAL	90.0	0.0 to 100.0	%	STOPPED	ENGINEER	4	01417
0446	VHz User Volts[10]	Parameters::Motor Control::Fluxing VHz	REAL	100.0	0.0 to 100.0	%	STOPPED	ENGINEER	4	01419
0447	Fixed Boost	Same as PNO 422	REAL	0.0	0.0 to 25.0	%	ALWAYS	TECHNICIAN	6,4	01421
0448	Auto Boost	Parameters::Motor Control::Fluxing VHz	REAL	0.0	0.0 to 25.0	%	ALWAYS	TECHNICIAN	6,4	01423
0450	Acceleration Boost	Parameters::Motor Control::Fluxing VHz	REAL	0.0	0.0 to 25.0	%	ALWAYS	TECHNICIAN	4	01427
0451	Energy Saving Enable	Parameters::Motor Control::Fluxing VHz	BOOL	FALSE			ALWAYS	TECHNICIAN	4	01429
0453	Vsd Demand	Parameters::Motor Control::Fluxing VHz	REAL	x.x	Min to Max	%	NEVER	TECHNICIAN	4	01433
0454	Vsq Demand	Parameters::Motor Control::Fluxing VHz	REAL	x.x	Min to Max	%	NEVER	TECHNICIAN	4	01435
0455	Rated Motor Current	Setup::Motor Control::Motor Nameplate Parameters::Motor Control::Motor Nameplate	REAL	1.56	0.0 to 10000.00	A	STOPPED	TECHNICIAN	6,4	01437
0456	Base Voltage	Same as PNO 455	REAL	400.00	0.00 to 1000.00	V	STOPPED	TECHNICIAN	6,4	01439
0457	Base Frequency	Same as PNO 455	REAL	50.00	0.00 to 1000.00	Hz	STOPPED	TECHNICIAN	6,4	01441
0458	Motor Poles	Same as PNO 455	INT	4,	2 to 1000		STOPPED	TECHNICIAN	6,4	01443
0459	Nameplate Speed	Same as PNO 455	REAL	1450.00	0.00 to 100000.00	RPM	STOPPED	TECHNICIAN	6,4	01445
0460	Motor Power	Same as PNO 455	REAL	0.75	0.00 to 3000.00	kW	STOPPED	TECHNICIAN	6,4	01447
0461	Power Factor	Same as PNO 455	REAL	0.71	0.00 to 1.00		STOPPED	TECHNICIAN	6,4	01449
0464	100% Speed in RPM	Setup::Motor Control::Control and Type Parameters::Motor Control::Scale Setpoint	REAL	1500.0	0.0 to 100000.0	RPM	ALWAYS	TECHNICIAN		01455
0465	Speed Demand RPM	Parameters::Motor Control::Scale Setpoint	REAL	x.x	0.0 to 100000.0	RPM	NEVER	TECHNICIAN		01457
0466	Speed Demand Hz	Parameters::Motor Control::Scale Setpoint	REAL	x.x	0.0 to 60000.0	Hz	NEVER	TECHNICIAN		01459
0467	PMAC SVC Auto Values	Parameters::Motor Control::PMAC SVC	BOOL	TRUE			ALWAYS	TECHNICIAN	6,4	01461
0468	PMAC SVC LPF Speed Hz	Parameters::Motor Control::PMAC SVC	REAL	60.00	0.00 to 10000.00	Hz	ALWAYS	TECHNICIAN	6,4	01463
0469	PMAC SVC P Gain	Parameters::Motor Control::PMAC SVC	REAL	2.42	0.00 to 10000.00		ALWAYS	TECHNICIAN	6,4	01465
0470	PMAC SVC I Gain Hz	Parameters::Motor Control::PMAC SVC	REAL	20.00	0.00 to 10000.00	Hz	ALWAYS	TECHNICIAN	6,4	01467
0476	PMAC SVC Open Loop Strt	Parameters::Motor Control::PMAC SVC	BOOL	TRUE			ALWAYS	TECHNICIAN	4	01479
0477	PMAC SVC Start Time	Parameters::Motor Control::PMAC SVC	TIME	0.500	0.000 to 1000.000	s	ALWAYS	TECHNICIAN	4	01481
0478	PMAC SVC Start Cur	Setup::Motor Control::SVC PMAC Parameters::Motor Control::PMAC SVC	REAL	10.0	0.0 to 600.0	%	ALWAYS	TECHNICIAN	4	01483
0479	PMAC SVC Start Speed	Same as PNO 478	REAL	5	0 to 200	%	ALWAYS	TECHNICIAN	4	01485
0484	Seq Stop Method VHz	Setup::Motor Control::Control and Type Parameters::Motor Control::Ramp	USINT (enum)	1	0:DISABLED VOLTAGE 1:RAMP 2:STOP RAMP 3:DC INJECTION		ALWAYS	TECHNICIAN	4	01495
0485	Ramp Type	Parameters::Motor Control::Ramp	USINT (enum)	0	0:LINEAR 1:S RAMP		ALWAYS	TECHNICIAN		01497
0486	Acceleration Time	Same as PNO 484	TIME	10.000	0.000 to 3000.000	s	ALWAYS	TECHNICIAN	6	01499
0487	Deceleration Time	Same as PNO 484	TIME	10.000	0.000 to 3000.000	s	ALWAYS	TECHNICIAN	6	01501
0488	Symmetric Mode	Parameters::Motor Control::Ramp	BOOL	FALSE			ALWAYS	TECHNICIAN	6	01503
0489	Symmetric Time	Parameters::Motor Control::Ramp	TIME	10.000	0.000 to 3000.000	s	ALWAYS	TECHNICIAN		01505

Parameter Reference C-239

PNO	Name	Path	Type	Default	Range	Units	WQ	View	Notes	Mbus
0490	Sramp Continuous	Parameters::Motor Control::Ramp	BOOL	FALSE			ALWAYS	TECHNICIAN		01507
0491	Sramp Acceleration	Parameters::Motor Control::Ramp	REAL	10.0	0.0 to 100.0	%/s ²	ALWAYS	OPERATOR		01509
0492	Sramp Deceleration	Parameters::Motor Control::Ramp	REAL	10.0	0.0 to 100.0	%/s ²	ALWAYS	TECHNICIAN		01511
0493	Sramp Jerk 1	Parameters::Motor Control::Ramp	REAL	10.0	0.0 to 100.0	%/s ³	ALWAYS	TECHNICIAN		01513
0494	Sramp Jerk 2	Parameters::Motor Control::Ramp	REAL	10.0	0.0 to 100.0	%/s ³	ALWAYS	TECHNICIAN		01515
0495	Sramp Jerk 3	Parameters::Motor Control::Ramp	REAL	10.0	0.0 to 100.0	%/s ³	ALWAYS	TECHNICIAN		01517
0496	Sramp Jerk 4	Parameters::Motor Control::Ramp	REAL	10.0	0.0 to 100.0	%/s ³	ALWAYS	TECHNICIAN		01519
0497	Ramp Hold	Parameters::Motor Control::Ramp	BOOL	FALSE			ALWAYS	TECHNICIAN		01521
0498	Ramping Active	Parameters::Motor Control::Ramp	BOOL				NEVER	TECHNICIAN		01523
0499	Ramp Spd Setpoint Input	Parameters::Motor Control::Ramp	REAL	x.x	-200.0 to 200.0	%	NEVER	TECHNICIAN		01525
0500	Ramp Speed Output	Parameters::Motor Control::Ramp	REAL	x.x	-200.0 to 200.0	%	NEVER	TECHNICIAN		01527
0501	Jog Setpoint	Parameters::Motor Control::Ramp	REAL	10.0	0.0 to 100.0	%	ALWAYS	TECHNICIAN		01529
0502	Jog Acceleration Time	Parameters::Motor Control::Ramp	TIME	1.000	0.000 to 3000.000	s	ALWAYS	TECHNICIAN		01531
0503	Jog Deceleration Time	Parameters::Motor Control::Ramp	TIME	1.000	0.000 to 3000.000	s	ALWAYS	TECHNICIAN		01533
0504	Stop Ramp Time	Same as PNO 484	TIME	10.000	0.000 to 600.000	s	ALWAYS	TECHNICIAN		01535
0505	Zero Speed Threshold	Parameters::Motor Control::Ramp	REAL	0.1	0.0 to 100.0	%	ALWAYS	TECHNICIAN		01537
0506	Zero Speed Stop Delay	Parameters::Motor Control::Ramp	TIME	0.500	0.000 to 30.000	s	ALWAYS	TECHNICIAN		01539
0507	Quickstop Time Limit	Parameters::Motor Control::Ramp	TIME	30.000	0.000 to 3000.000	s	ALWAYS	TECHNICIAN		01541
0508	Quickstop Ramp Time	Parameters::Motor Control::Ramp	TIME	0.100	0.000 to 600.000	s	ALWAYS	TECHNICIAN		01543
0509	Final Stop Rate	Parameters::Motor Control::Ramp	REAL	1200	1 to 4800	Hz/s	ALWAYS	TECHNICIAN		01545
0511	Motor Type or AFE	Setup::Motor Control::Control and Type Setup::Regen Control Parameters::Control Mode::Control Mode	USINT (enum)	0	0:INDUCTION MOTOR 1:PMAC MOTOR 2:AFE		STOPPED	TECHNICIAN	6	01549
0512	Control Strategy	Setup::Motor Control::Control and Type Parameters::Control Mode::Control Mode	USINT (enum)	0	0:VOLTS - HERTZ CONTROL 1:VECTOR CONTROL		STOPPED	TECHNICIAN	6,4	01551
0513	Active 33 - 64	Monitor::Trips Parameters::Trips::Trips Status	DWORD				NEVER	OPERATOR		01553
0514	Warnings 33 - 64	Same as PNO 513	DWORD				NEVER	OPERATOR		01555
0515	Speed Loop Pgain	Parameters::Motor Control::Spd Loop Settings	REAL	20.00	0.00 to 3000.00		ALWAYS	TECHNICIAN	4	01557
0516	Speed Loop I Time	Parameters::Motor Control::Spd Loop Settings	TIME	0.100	0.001 to 15.000	s	ALWAYS	TECHNICIAN	4	01559
0517	Speed Loop Int Defeat	Parameters::Motor Control::Spd Loop Settings	BOOL	FALSE			ALWAYS	TECHNICIAN	4	01561
0518	Speed Loop Int Preset	Parameters::Motor Control::Spd Loop Settings	REAL	0	-600 to 600		ALWAYS	TECHNICIAN	4	01563
0519	Spd Loop Dmd Filt TC	Parameters::Motor Control::Spd Loop Settings	REAL	0.0	0.0 to 15.0	ms	ALWAYS	TECHNICIAN	4	01565
0520	Spd Loop Fbk Filt TC	Parameters::Motor Control::Spd Loop Settings	REAL	1.0	0.0 to 15.0	ms	ALWAYS	TECHNICIAN	4	01567
0521	Spd Loop Aux Torq Dmd	Parameters::Motor Control::Spd Loop Settings	REAL	0.00	-600.00 to 600.00	%	ALWAYS	TECHNICIAN	4	01569
0523	Spd Loop Adapt Thres	Parameters::Motor Control::Spd Loop Settings	REAL	0.00	0.00 to 10.00	%	ALWAYS	TECHNICIAN	4	01573
0524	Spd Loop Adapt Pgain	Parameters::Motor Control::Spd Loop Settings	REAL	20.00	0.00 to 300.00		ALWAYS	TECHNICIAN	4	01575
0525	Spd Demand Pos Lim	Parameters::Motor Control::Spd Loop Settings	REAL	110.00	-110.00 to 110.00	%	ALWAYS	TECHNICIAN	4	01577
0526	Spd Demand Neg Lim	Parameters::Motor Control::Spd Loop Settings	REAL	-110.00	-110.00 to 110.00	%	ALWAYS	TECHNICIAN	4	01579
0527	Sel Torq Ctrl Only	Parameters::Motor Control::Spd Loop Settings	BOOL	FALSE			ALWAYS	TECHNICIAN	4	01581
0528	Direct Input Select	Parameters::Motor Control::Spd Direct Input	USINT (enum)	0	0:NONE 1:ANIN1 2:ANIN2		ALWAYS	TECHNICIAN	4	01583
0529	Direct Input Ratio	Parameters::Motor Control::Spd Direct Input	REAL	1.0000	-10.0000 to 10.0000		ALWAYS	TECHNICIAN	4	01585
0530	Direct Input Pos Lim	Parameters::Motor Control::Spd Direct Input	REAL	110.00	-600.00 to 600.00	%	ALWAYS	TECHNICIAN	4	01587
0531	Direct Input Neg Lim	Parameters::Motor Control::Spd Direct Input	REAL	-110.00	-600.00 to 600.00	%	ALWAYS	TECHNICIAN	4	01589
0533	Total Spd Demand RPM	Parameters::Motor Control::Spd Loop Diagnostics	REAL	x.xx	-100000.00 to 100000.00	RPM	NEVER	TECHNICIAN	4	01593
0534	Total Spd Demand %	Parameters::Motor Control::Spd Loop Diagnostics	REAL	x.xx	-200.00 to 200.00	%	NEVER	TECHNICIAN	4	01595
0535	Speed Loop Error	Parameters::Motor Control::Spd Loop Diagnostics	REAL	x.xx	-600.00 to 600.00	%	NEVER	TECHNICIAN	4	01597
0536	Speed PI Output	Parameters::Motor Control::Spd Loop Diagnostics	REAL	x.xx	-600.00 to 600.00	%	NEVER	TECHNICIAN	4	01599
0543	Power Stack Fitted	Parameters::Device Manager::Drive info	USINT (enum)		0:NONE 1:3.5 A 400 V 2:4.5 A 400 V 3:5.5 A 400 V 4:7.5 A 400 V 5:10.0 A 400 V 6:12.0 A 400 V 7:16.0 A 400 V 8:23.0 A 400 V 9:32.0 A 400 V 10:38.0 A 400 V 11:45.0 A 400 V R1 12:60.0 A 400 V R1		NEVER	TECHNICIAN		01613

C-240 Parameter Reference

PNO	Name	Path	Type	Default	Range	Units	WQ	View	Notes	MBus		
					13:73.0 A 400 V R1 14:87.0 A 400 V 15:105 A 400 V 16:145 A 400 V 17:180 A 400 V 18:205 A 400 V 19:260 A 400 V 20:45.0 A 400 V 21:60.0 A 400 V 22:73.0 A 400 V 23:315 A 400 V 24:380 A 400 V 25:440 A 400 V 26:530 A 400 V 27:590 A 400 V 28:650 A 400 V 29:700 A 400 V 30:790 A 400 V 31:45.0 A 400 V r3							
0555	PMAC Max Speed	Setup::Motor Control::Motor Data PMAC Parameters::Motor Control::PMAC Motor Data	REAL	3000	0 to 100000	RPM	ALWAYS	TECHNICIAN	6,4	01637		
0556	PMAC Max Current	Same as PNO 555	REAL	4.50	0.00 to 5000.00	A	ALWAYS	TECHNICIAN	6,4	01639		
0557	PMAC Rated Current	Same as PNO 555	REAL	4.50	0.00 to 5000.00	A	ALWAYS	TECHNICIAN	6,4	01641		
0558	PMAC Rated Torque	Same as PNO 555	REAL	4.50	0.00 to 30000.00	Nm	ALWAYS	TECHNICIAN	6,9,4	01643		
0559	PMAC Motor Poles	Same as PNO 555	UINT	10	0 to 400		ALWAYS	TECHNICIAN	6,4	01645		
0560	PMAC Back Emf Const KE	Same as PNO 555	REAL	60.0	0.0 to 30000.0	V	ALWAYS	TECHNICIAN	6,9,4	01647		
0561	PMAC Winding Resistance	Same as PNO 555	REAL	6.580	0.000 to 500.000	Ohm	ALWAYS	TECHNICIAN	6,9,4	01649		
0562	PMAC Winding Inductance	Same as PNO 555	REAL	20.00	0.00 to 1000.00	mH	ALWAYS	TECHNICIAN	6,9,4	01651		
0563	PMAC Torque Const KT	Same as PNO 555	REAL	1.00	0.00 to 10000.00	Nm/A	ALWAYS	TECHNICIAN	6,9,4	01653		
0564	PMAC Motor Inertia	Same as PNO 555	REAL	0.00100	0.00000 to 100.00000	kgm ²	ALWAYS	TECHNICIAN	6,4	01655		
0565	PMAC Therm Time Const	Same as PNO 555	TIME	62.000	0.000 to 10000.000	s	ALWAYS	TECHNICIAN	6,4	01657		
0568	Magnetising Current	Parameters::Motor Control::Induction Motor Data	REAL	1.00	0.00 to 10000.00	A	ALWAYS	ENGINEER	6,9,4	01663		
0569	Rotor Time Constant	Parameters::Motor Control::Induction Motor Data	TIME	0.100	0.005 to 100.000	s	ALWAYS	ENGINEER	6,9,4	01665		
0570	Leakage Inductance	Parameters::Motor Control::Induction Motor Data	REAL	1.000	0.000 to 1000.000	mH	ALWAYS	ENGINEER	6,9,4	01667		
0571	Stator Resistance	Parameters::Motor Control::Induction Motor Data	REAL	0.0000	0.0000 to 100.0000	Ohm	ALWAYS	ENGINEER	6,9,4	01669		
0572	Mutual Inductance	Parameters::Motor Control::Induction Motor Data	REAL	100.00	0.00 to 10000.00	mH	ALWAYS	ENGINEER	6,9,4	01671		
0591	Local	Parameters::Motor Control::Sequencing	BOOL	FALSE			STOPPED	TECHNICIAN		01709		
0592	Local Reference	Parameters::Motor Control::Sequencing	REAL	0.00	0.00 to 100.00	%	ALWAYS	OPERATOR		01711		
0610	App Control Word	Parameters::Motor Control::Sequencing	WORD (bitfield)	0000	Same as PNO 593		ALWAYS	ENGINEER	2	01747		
0611	App Control Word.SWITCH ON	Parameters::Motor Control::Sequencing	BOOL	FALSE			ALWAYS	ENGINEER	2	01749		
0612	App Control Word.ENABLE VOLTAGE	Parameters::Motor Control::Sequencing	BOOL	FALSE			ALWAYS	ENGINEER	2	01751		
0613	App Control Word.NOT QUICKSTOP	Parameters::Motor Control::Sequencing	BOOL	FALSE			ALWAYS	ENGINEER	2	01753		
0614	App Control Word.ENABLE OPERATION	Parameters::Motor Control::Sequencing	BOOL	FALSE			ALWAYS	ENGINEER	2	01755		
0618	App Control Word.RESET FAULT	Parameters::Motor Control::Sequencing	BOOL	FALSE			ALWAYS	ENGINEER	2	01763		
0619	App Control Word.EXTERNAL FAULT	Parameters::Motor Control::Sequencing	BOOL	FALSE			ALWAYS	ENGINEER	2	01765		
0623	App Control Word.USE JOG REFERENCE	Parameters::Motor Control::Sequencing	BOOL	FALSE			ALWAYS	ENGINEER	2	01773		
0624	App Control Word.REVERSE DIRECTION	Parameters::Motor Control::Sequencing	BOOL	FALSE			ALWAYS	ENGINEER	2	01775		
0625	App Control Word.AUTO INITIALISE	Parameters::Motor Control::Sequencing	BOOL	FALSE			ALWAYS	ENGINEER	2	01777		
0626	App Control Word.EVENT TRIGGERED OP	Parameters::Motor Control::Sequencing	BOOL	FALSE			ALWAYS	ENGINEER	2	01779		
0627	Comms Control Word	Parameters::Motor Control::Sequencing	WORD (bitfield)	0000	0:SWITCH ON 1:ENABLE VOLTAGE 2:NOT QUICKSTOP 3:ENABLE OPERATION 7:RESET FAULT 8:EXTERNAL FAULT 10:USE COMMS CONTROL 11:USE COMMS REFERENCE 12:USE JOG REFERENCE 13:REVERSE DIRECTION 14:AUTO INITIALISE 15:EVENT TRIGGERED OP		ALWAYS	TECHNICIAN	2	01781		
0628	Comms Control Word.SWITCH ON	Parameters::Motor Control::Sequencing	BOOL	FALSE			ALWAYS	TECHNICIAN	2	01783		

Parameter Reference C-241

PNO	Name	Path	Type	Default	Range	Units	WQ	View	Notes	Mbus
0629	Comms Control Word.ENABLE VOLTAGE	Parameters::Motor Control::Sequencing	BOOL	FALSE			ALWAYS	TECHNICIAN	2	01785
0630	Comms Control Word.NOT QUICKSTOP	Parameters::Motor Control::Sequencing	BOOL	FALSE			ALWAYS	TECHNICIAN	2	01787
0631	Comms Control Word.ENABLE OPERATION	Parameters::Motor Control::Sequencing	BOOL	FALSE			ALWAYS	TECHNICIAN	2	01789
0635	Comms Control Word.RESET FAULT	Parameters::Motor Control::Sequencing	BOOL	FALSE			ALWAYS	TECHNICIAN	2	01797
0636	Comms Control Word.EXTERNAL FAULT	Parameters::Motor Control::Sequencing	BOOL	FALSE			ALWAYS	TECHNICIAN	2	01799
0638	Comms Control Word.USE COMMS CONTROL	Parameters::Motor Control::Sequencing	BOOL	FALSE			ALWAYS	TECHNICIAN	2	01803
0639	Comms Control Word.USE COMMS REFERENCE	Parameters::Motor Control::Sequencing	BOOL	FALSE			ALWAYS	TECHNICIAN	2	01805
0640	Comms Control Word.USE JOG REFERENCE	Parameters::Motor Control::Sequencing	BOOL	FALSE			ALWAYS	TECHNICIAN	2	01807
0641	Comms Control Word.REVERSE DIRECTION	Parameters::Motor Control::Sequencing	BOOL	FALSE			ALWAYS	TECHNICIAN	2	01809
0642	Comms Control Word.AUTO INITIALISE	Parameters::Motor Control::Sequencing	BOOL	FALSE			ALWAYS	TECHNICIAN	2	01811
0643	Comms Control Word.EVENT TRIGGERED OP	Parameters::Motor Control::Sequencing	BOOL	FALSE			ALWAYS	TECHNICIAN	2	01813
0644	Control Word	Parameters::Motor Control::Sequencing	WORD (bitfield)		Same as PNO 627		NEVER	TECHNICIAN		01815
0645	Control Word.SWITCH ON	Parameters::Motor Control::Sequencing	BOOL				NEVER	TECHNICIAN		01817
0646	Control Word.ENABLE VOLTAGE	Parameters::Motor Control::Sequencing	BOOL				NEVER	TECHNICIAN		01819
0647	Control Word.NOT QUICKSTOP	Parameters::Motor Control::Sequencing	BOOL				NEVER	TECHNICIAN		01821
0648	Control Word.ENABLE OPERATION	Parameters::Motor Control::Sequencing	BOOL				NEVER	TECHNICIAN		01823
0652	Control Word.RESET FAULT	Parameters::Motor Control::Sequencing	BOOL				NEVER	TECHNICIAN		01831
0653	Control Word.EXTERNAL FAULT	Parameters::Motor Control::Sequencing	BOOL				NEVER	TECHNICIAN		01833
0655	Control Word.USE COMMS CONTROL	Parameters::Motor Control::Sequencing	BOOL				NEVER	TECHNICIAN		01837
0656	Control Word.USE COMMS REFERENCE	Parameters::Motor Control::Sequencing	BOOL				NEVER	TECHNICIAN		01839
0657	Control Word.USE JOG REFERENCE	Parameters::Motor Control::Sequencing	BOOL				NEVER	TECHNICIAN		01841
0658	Control Word.REVERSE DIRECTION	Parameters::Motor Control::Sequencing	BOOL				NEVER	TECHNICIAN		01843
0659	Control Word.AUTO INITIALISE	Parameters::Motor Control::Sequencing	BOOL				NEVER	TECHNICIAN		01845
0660	Control Word.EVENT TRIGGERED OP	Parameters::Motor Control::Sequencing	BOOL				NEVER	TECHNICIAN		01847
0661	Status Word	Parameters::Motor Control::Sequencing	WORD (bitfield)		0:READY TO SWITCH ON 1:SWITCHED ON 2:OPERATION ENABLED 3:FAULTED 4:VOLTAGE ENABLED 5:QUICKSTOP INACTIVE 6:SWITCH ON DISABLED 9:CONTROL FROM COMMS 12:JOG OPERATION 13:REVERSE OPERATION 14:REFERENCE FROM COMMS 15:STOPPING		NEVER	TECHNICIAN		01849
0662	Status Word.READY TO SWITCH ON	Parameters::Motor Control::Sequencing	BOOL				NEVER	TECHNICIAN		01851
0663	Status Word.SWITCHED ON	Parameters::Motor Control::Sequencing	BOOL				NEVER	TECHNICIAN		01853
0664	Status Word.OPERATION ENABLED	Parameters::Motor Control::Sequencing	BOOL				NEVER	TECHNICIAN		01855
0665	Status Word.FAULTED	Parameters::Motor Control::Sequencing	BOOL				NEVER	TECHNICIAN		01857
0666	Status Word.VOLTAGE ENABLED	Parameters::Motor Control::Sequencing	BOOL				NEVER	TECHNICIAN		01859
0667	Status Word.QUICKSTOP INACTIVE	Parameters::Motor Control::Sequencing	BOOL				NEVER	TECHNICIAN		01861
0668	Status Word.SWITCH ON DISABLED	Parameters::Motor Control::Sequencing	BOOL				NEVER	TECHNICIAN		01863
0671	Status Word.CONTROL FROM COMMS	Parameters::Motor Control::Sequencing	BOOL				NEVER	TECHNICIAN		01869
0674	Status Word.JOG OPERATION	Parameters::Motor Control::Sequencing	BOOL				NEVER	TECHNICIAN		01875
0675	Status Word.REVERSE OPERATION	Parameters::Motor Control::Sequencing	BOOL				NEVER	TECHNICIAN		01877
0676	Status Word.REFERENCE FROM COMMS	Parameters::Motor Control::Sequencing	BOOL				NEVER	TECHNICIAN		01879
0677	Status Word.STOPPING	Parameters::Motor Control::Sequencing	BOOL				NEVER	TECHNICIAN		01881
0678	Sequencing State	Parameters::Motor Control::Sequencing	USINT (enum)		0:NOT READY TO SWITCH ON 1:SWITCH ON DISABLED 2:READY TO SWITCH ON 3:SWITCHED ON 4:OPERATION ENABLED 5:QUICKSTOP ACTIVE 6:FAULT REACTION ACTIVE 7:FAULTED		NEVER	TECHNICIAN		01883
0679	Switch On Timeout	Parameters::Motor Control::Sequencing	TIME	0.000	0.000 to 100.000	s	ALWAYS	TECHNICIAN		01885
0680	App Reference	Parameters::Motor Control::Sequencing	REAL	0.00	-110.00 to 110.00	%	ALWAYS	TECHNICIAN		01887
0681	Comms Reference	Parameters::Motor Control::Sequencing	REAL	0.00	-110.00 to 110.00	%	ALWAYS	TECHNICIAN		01889
0682	Reference	Parameters::Motor Control::Sequencing	REAL	x.xx	-110.00 to 110.00	%	NEVER	OPERATOR		01891
0686	Anout 01 Scale	Setup::Inputs and Outputs::Base IO	REAL	1.0000	Min to Max		ALWAYS	OPERATOR		01899

C-242 Parameter Reference

PNO	Name	Path	Type	Default	Range	Units	WQ	View	Notes	Mbus
0687	Boot Version Number	Parameters::Inputs And Outputs::IO Configure					NEVER	ENGINEER		01901
0688	Drive Diagnostic	Parameters::Device Manager::Drive info	USINT (enum)		0:OK 1:STACK NOT CONNECTED 2:STACK DATA CORRUPT 3:UNKNOWN STACK 4:STACK MISMATCH		NEVER	OPERATOR		01903
0689	PMAC Flycatching Enable	Parameters::Motor Control::PMAC Flycatching	BOOL	FALSE			ALWAYS	TECHNICIAN	4	01905
0690	PMAC Fly Search Mode	Parameters::Motor Control::PMAC Flycatching	USINT (enum)	0	Same as PNO 312		ALWAYS	TECHNICIAN	4	01907
0691	PMAC Fly Search Time	Parameters::Motor Control::PMAC Flycatching	TIME	0.200	0.100 to 60.000	s	ALWAYS	TECHNICIAN	4	01909
0692	PMAC Fly Load Level	Parameters::Motor Control::PMAC Flycatching	REAL	5.0	-50.0 to 50.0	%	ALWAYS	TECHNICIAN	4	01911
0693	PMAC Fly Active	Parameters::Motor Control::PMAC Flycatching	BOOL				NEVER	TECHNICIAN	4	01913
0694	PMAC Fly Setpoint	Parameters::Motor Control::PMAC Flycatching	REAL	x.	-1000 to 1000	Hz	NEVER	TECHNICIAN	4	01915
0695	Attached to Stack	Parameters::Device Manager::Drive info	BOOL				NEVER	ENGINEER		01917
0696	First Trip	Monitor::Trips Parameters::Trips::Trips Status	USINT (enum)		0:NONE 1:01 OVER VOLTAGE 2:02 UNDER VOLTAGE 3:03 OVER CURRENT 4:04 STACK FAULT 5:05 STACK OVER CURRENT 6:06 CURRENT LIMIT 7:07 MOTOR STALL 8:08 INVERSE TIME 9:09 MOTOR I2T 10:10 LOW SPEED I 11:11 HEATSINK OVERTEMP 12:12 INTERNAL OVERTEMP 13:13 MOTOR OVERTEMP 14:14 EXTERNAL TRIP 15:15 BRAKE SHORT CCT 16:16 BRAKE RESISTOR 17:17 BRAKE SWITCH 18:18 LOCAL CONTROL 19:19 COMMS BREAK 20:20 LINE CONTACTOR 21:21 PHASE FAIL 22:22 VDC RIPPLE 23:23 BASE MODBUS BREAK 24:24 24 V OVERLOAD 25:25 PMAC SPEED ERROR 26:26 OVERSPEED 27:27 STO ACTIVE 28:28 FEEDBACK MISSING 29:29 INTERNAL FAN FAIL 30:30 CURRENT SENSOR 31:31 POWER LOSS STOP 32:32 SPEED SENSOR 33:33 A1 34:34 A2 35:35 A3 36:36 A4 37:37 A5 38:38 A6 39:39 A7 40:40 A8 41:41 SPEED ERROR 42:42 PEERTOPEER OVERRUN 43:43 PHASE CONFIG 44:44 FIELD BUS BREAK 45:45 RESOLVER ERROR 46:46 PMAC ALIGN ERROR 47:47 CURRENT IMBALANCE 48:48 CONFIGURATION 49:49 APPLICATION 50:50 AC30A ENCODER 51:51 CPU USAGE		NEVER	OPERATOR		01919
0697	Enable 1 - 32	Parameters::Trips::Trips Status	DWORD	FFFFFF7F	5:06 CURRENT LIMIT		ALWAYS	TECHNICIAN		01921

Parameter Reference C-243

PNO	Name	Path	Type	Default	Range	Units	WQ	View	Notes	MBus
			(bitfield)		6:07 MOTOR STALL 7:08 INVERSE TIME 8:09 MOTOR I2T 9:10 LOW SPEED I 11:12 INTERNAL OVERTEMP 12:13 MOTOR OVERTEMP 13:14 EXTERNAL TRIP 14:15 BRAKE SHORT CCT 15:16 BRAKE RESISTOR 16:17 BRAKE SWITCH 17:18 LOCAL CONTROL 18:19 COMMS BREAK 19:20 LINE CONTACTOR 20:21 PHASE FAIL 21:22 VDC RIPPLE 22:23 BASE MODBUS BREAK 23:24 24 V OVERLOAD 24:25 PMAC SPEED ERROR 25:26 OVERSPEED 28:29 INTERNAL FAN FAIL 29:30 CURRENT SENSOR 30:31 POWER LOSS STOP 31:32 SPEED SENSOR					
0703	Enable 1 - 32.06 CURRENT LIMIT	Parameters::Trips::Trips Status	BOOL	TRUE			ALWAYS	TECHNICIAN		01933
0704	Enable 1 - 32.07 MOTOR STALL	Parameters::Trips::Trips Status	BOOL	TRUE			ALWAYS	TECHNICIAN		01935
0705	Enable 1 - 32.08 INVERSE TIME	Parameters::Trips::Trips Status	BOOL	FALSE			ALWAYS	TECHNICIAN		01937
0706	Enable 1 - 32.09 MOTOR I2T	Parameters::Trips::Trips Status	BOOL	TRUE			ALWAYS	TECHNICIAN		01939
0707	Enable 1 - 32.10 LOW SPEED I	Parameters::Trips::Trips Status	BOOL	TRUE			ALWAYS	TECHNICIAN		01941
0709	Enable 1 - 32.12 INTERNAL OVERTEMP	Parameters::Trips::Trips Status	BOOL	TRUE			ALWAYS	TECHNICIAN		01945
0710	Enable 1 - 32.13 MOTOR OVERTEMP	Parameters::Trips::Trips Status	BOOL	TRUE			ALWAYS	TECHNICIAN		01947
0711	Enable 1 - 32.14 EXTERNAL TRIP	Parameters::Trips::Trips Status	BOOL	TRUE			ALWAYS	TECHNICIAN		01949
0712	Enable 1 - 32.15 BRAKE SHORT CCT	Parameters::Trips::Trips Status	BOOL	TRUE			ALWAYS	TECHNICIAN		01951
0713	Enable 1 - 32.16 BRAKE RESISTOR	Parameters::Trips::Trips Status	BOOL	TRUE			ALWAYS	TECHNICIAN		01953
0714	Enable 1 - 32.17 BRAKE SWITCH	Parameters::Trips::Trips Status	BOOL	TRUE			ALWAYS	TECHNICIAN		01955
0715	Enable 1 - 32.18 LOCAL CONTROL	Parameters::Trips::Trips Status	BOOL	TRUE			ALWAYS	TECHNICIAN		01957
0716	Enable 1 - 32.19 COMMS BREAK	Parameters::Trips::Trips Status	BOOL	TRUE			ALWAYS	TECHNICIAN		01959
0717	Enable 1 - 32.20 LINE CONTACTOR	Parameters::Trips::Trips Status	BOOL	TRUE			ALWAYS	TECHNICIAN		01961
0718	Enable 1 - 32.21 PHASE FAIL	Parameters::Trips::Trips Status	BOOL	TRUE			ALWAYS	TECHNICIAN		01963
0719	Enable 1 - 32.22 VDC RIPPLE	Parameters::Trips::Trips Status	BOOL	TRUE			ALWAYS	TECHNICIAN		01965
0720	Enable 1 - 32.23 BASE MODBUS BREAK	Parameters::Trips::Trips Status	BOOL	TRUE			ALWAYS	TECHNICIAN		01967
0721	Enable 1 - 32.24 24 V OVERLOAD	Parameters::Trips::Trips Status	BOOL	TRUE			ALWAYS	TECHNICIAN		01969
0722	Enable 1 - 32.25 PMAC SPEED ERROR	Parameters::Trips::Trips Status	BOOL	TRUE			ALWAYS	TECHNICIAN		01971
0723	Enable 1 - 32.26 OVERSPEED	Parameters::Trips::Trips Status	BOOL	TRUE			ALWAYS	TECHNICIAN		01973
0726	Enable 1 - 32.29 INTERNAL FAN FAIL	Parameters::Trips::Trips Status	BOOL	TRUE			ALWAYS	TECHNICIAN		01979
0727	Enable 1 - 32.30 CURRENT SENSOR	Parameters::Trips::Trips Status	BOOL	TRUE			ALWAYS	TECHNICIAN		01981
0728	Enable 1 - 32.31 POWER LOSS STOP	Parameters::Trips::Trips Status	BOOL	TRUE			ALWAYS	TECHNICIAN		01983
0729	Enable 1 - 32.32 SPEED SENSOR	Parameters::Trips::Trips Status	BOOL	TRUE			ALWAYS	TECHNICIAN		01985
0730	Enable 33 - 64	Parameters::Trips::Trips Status	DWORD (bitfield)	FFFFFFFF	0:33 A1 1:34 A2 2:35 A3 3:36 A4 4:37 A5 5:38 A6 6:39 A7 7:40 A8 8:41 SPEED ERROR 9:42 PEERTOPEER OVERRUN 10:43 PHASE CONFIG 11:44 FIELD BUS BREAK 14:47 CURRENT IMBALANCE 16:49 APPLICATION 18:51 CPU USAGE		ALWAYS	TECHNICIAN		01987
0731	Enable 33 - 64.33 A1	Parameters::Trips::Trips Status	BOOL	TRUE			ALWAYS	TECHNICIAN		01989
0732	Enable 33 - 64.34 A2	Parameters::Trips::Trips Status	BOOL	TRUE			ALWAYS	TECHNICIAN		01991
0733	Enable 33 - 64.35 A3	Parameters::Trips::Trips Status	BOOL	TRUE			ALWAYS	TECHNICIAN		01993
0734	Enable 33 - 64.36 A4	Parameters::Trips::Trips Status	BOOL	TRUE			ALWAYS	TECHNICIAN		01995
0735	Enable 33 - 64.37 A5	Parameters::Trips::Trips Status	BOOL	TRUE			ALWAYS	TECHNICIAN		01997

C-244 Parameter Reference

PNO	Name	Path	Type	Default	Range	Units	WQ	View	Notes	Mbus
0736	Enable 33 - 64.38 A6	Parameters::Trips::Trips Status	BOOL	TRUE			ALWAYS	TECHNICIAN		01999
0737	Enable 33 - 64.39 A7	Parameters::Trips::Trips Status	BOOL	TRUE			ALWAYS	TECHNICIAN		02001
0738	Enable 33 - 64.40 A8	Parameters::Trips::Trips Status	BOOL	TRUE			ALWAYS	TECHNICIAN		02003
0739	Enable 33 - 64.41 SPEED ERROR	Parameters::Trips::Trips Status	BOOL	TRUE			ALWAYS	TECHNICIAN		02005
0740	Enable 33 - 64.42 PEERTOPEER OVERRUN	Parameters::Trips::Trips Status	BOOL	TRUE			ALWAYS	TECHNICIAN		02007
0741	Enable 33 - 64.43 PHASE CONFIG	Parameters::Trips::Trips Status	BOOL	TRUE			ALWAYS	TECHNICIAN		02009
0742	Enable 33 - 64.44 FIELDBUS BREAK	Parameters::Trips::Trips Status	BOOL	TRUE			ALWAYS	TECHNICIAN		02011
0745	Enable 33 - 64.47 CURRENT IMBALANCE	Parameters::Trips::Trips Status	BOOL	TRUE			ALWAYS	TECHNICIAN		02017
0747	Enable 33 - 64.49 APPLICATION	Parameters::Trips::Trips Status	BOOL	TRUE			ALWAYS	TECHNICIAN		02021
0749	Enable 33 - 64.51 CPU USAGE	Parameters::Trips::Trips Status	BOOL	TRUE			ALWAYS	TECHNICIAN		02025
0763	Active 1 - 32	Monitor::Trips Parameters::Trips::Trips Status	DWORD (bitfield)		0:01 OVER VOLTAGE 1:02 UNDER VOLTAGE 2:03 OVER CURRENT 3:04 STACK FAULT 4:05 STACK OVER CURRENT 5:06 CURRENT LIMIT 6:07 MOTOR STALL 7:08 INVERSE TIME 8:09 MOTOR I2T 9:10 LOW SPEED I 10:11 HEATSINK OVERTEMP 11:12 INTERNAL OVERTEMP 12:13 MOTOR OVERTEMP 13:14 EXTERNAL TRIP 14:15 BRAKE SHORT CCT 15:16 BRAKE RESISTOR 16:17 BRAKE SWITCH 17:18 LOCAL CONTROL 18:19 COMMS BREAK 19:20 LINE CONTACTOR 20:21 PHASE FAIL 21:22 VDC RIPPLE 22:23 BASE MODBUS BREAK 23:24 24 V OVERLOAD 24:25 PMAC SPEED ERROR 25:26 OVERSPEED 26:27 STO ACTIVE 27:28 FEEDBACK MISSING 28:29 INTERNAL FAN FAIL 29:30 CURRENT SENSOR 30:31 POWER LOSS STOP 31:32 SPEED SENSOR		NEVER	OPERATOR		02053
0764	Active 1 - 32.01 OVER VOLTAGE	Same as PNO 763	BOOL				NEVER	OPERATOR		02055
0765	Active 1 - 32.02 UNDER VOLTAGE	Same as PNO 763	BOOL				NEVER	OPERATOR		02057
0766	Active 1 - 32.03 OVER CURRENT	Same as PNO 763	BOOL				NEVER	OPERATOR		02059
0767	Active 1 - 32.04 STACK FAULT	Same as PNO 763	BOOL				NEVER	OPERATOR		02061
0768	Active 1 - 32.05 STACK OVER CURRENT	Same as PNO 763	BOOL				NEVER	OPERATOR		02063
0769	Active 1 - 32.06 CURRENT LIMIT	Same as PNO 763	BOOL				NEVER	OPERATOR		02065
0770	Active 1 - 32.07 MOTOR STALL	Same as PNO 763	BOOL				NEVER	OPERATOR		02067
0771	Active 1 - 32.08 INVERSE TIME	Same as PNO 763	BOOL				NEVER	OPERATOR		02069
0772	Active 1 - 32.09 MOTOR I2T	Same as PNO 763	BOOL				NEVER	OPERATOR		02071
0773	Active 1 - 32.10 LOW SPEED I	Same as PNO 763	BOOL				NEVER	OPERATOR		02073
0774	Active 1 - 32.11 HEATSINK OVERTEMP	Same as PNO 763	BOOL				NEVER	OPERATOR		02075
0775	Active 1 - 32.12 INTERNAL OVERTEMP	Same as PNO 763	BOOL				NEVER	OPERATOR		02077
0776	Active 1 - 32.13 MOTOR OVERTEMP	Same as PNO 763	BOOL				NEVER	OPERATOR		02079
0777	Active 1 - 32.14 EXTERNAL TRIP	Same as PNO 763	BOOL				NEVER	OPERATOR		02081
0778	Active 1 - 32.15 BRAKE SHORT CCT	Same as PNO 763	BOOL				NEVER	OPERATOR		02083
0779	Active 1 - 32.16 BRAKE RESISTOR	Same as PNO 763	BOOL				NEVER	OPERATOR		02085
0780	Active 1 - 32.17 BRAKE SWITCH	Same as PNO 763	BOOL				NEVER	OPERATOR		02087
0781	Active 1 - 32.18 LOCAL CONTROL	Same as PNO 763	BOOL				NEVER	OPERATOR		02089
0782	Active 1 - 32.19 COMMS BREAK	Same as PNO 763	BOOL				NEVER	OPERATOR		02091
0783	Active 1 - 32.20 LINE CONTACTOR	Same as PNO 763	BOOL				NEVER	OPERATOR		02093
0784	Active 1 - 32.21 PHASE FAIL	Same as PNO 763	BOOL				NEVER	OPERATOR		02095
0785	Active 1 - 32.22 VDC RIPPLE	Same as PNO 763	BOOL				NEVER	OPERATOR		02097
0786	Active 1 - 32.23 BASE MODBUS BREAK	Same as PNO 763	BOOL				NEVER	OPERATOR		02099
0787	Active 1 - 32.24 24 V OVERLOAD	Same as PNO 763	BOOL				NEVER	OPERATOR		02101
0788	Active 1 - 32.25 PMAC SPEED ERROR	Same as PNO 763	BOOL				NEVER	OPERATOR		02103
0789	Active 1 - 32.26 OVERSPEED	Same as PNO 763	BOOL				NEVER	OPERATOR		02105

Parameter Reference C-245

PNO	Name	Path	Type	Default	Range	Units	WQ	View	Notes	Mbus
0790	Active 1 - 32.27 STO ACTIVE	Same as PNO 763	BOOL				NEVER	OPERATOR		02107
0791	Active 1 - 32.28 FEEDBACK MISSING	Same as PNO 763	BOOL				NEVER	OPERATOR		02109
0792	Active 1 - 32.29 INTERNAL FAN FAIL	Same as PNO 763	BOOL				NEVER	OPERATOR		02111
0793	Active 1 - 32.30 CURRENT SENSOR	Same as PNO 763	BOOL				NEVER	OPERATOR		02113
0794	Active 1 - 32.31 POWER LOSS STOP	Same as PNO 763	BOOL				NEVER	OPERATOR		02115
0795	Active 1 - 32.32 SPEED SENSOR	Same as PNO 763	BOOL				NEVER	OPERATOR		02117
0796	AR Trip Mask 2	Setup::Motor Control::Auto Restart Parameters::Motor Control::Auto Restart	DWORD (bitfield)	FFFFFFFF	0:33 A1 1:34 A2 2:35 A3 3:36 A4 4:37 A5 5:38 A6 6:39 A7 7:40 A8 8:41 SPEED ERROR 9:42 PEERTOPEER OVERRUN 10:43 PHASE CONFIG 11:44 FIELDBUS BREAK 18:51 CPU USAGE		ALWAYS	TECHNICIAN		02119
0797	AR Trip Mask 2.33 A1	Same as PNO 796	BOOL	TRUE			ALWAYS	TECHNICIAN		02121
0798	AR Trip Mask 2.34 A2	Same as PNO 796	BOOL	TRUE			ALWAYS	TECHNICIAN		02123
0799	AR Trip Mask 2.35 A3	Same as PNO 796	BOOL	TRUE			ALWAYS	TECHNICIAN		02125
0800	AR Trip Mask 2.36 A4	Same as PNO 796	BOOL	TRUE			ALWAYS	TECHNICIAN		02127
0801	AR Trip Mask 2.37 A5	Same as PNO 796	BOOL	TRUE			ALWAYS	TECHNICIAN		02129
0802	AR Trip Mask 2.38 A6	Same as PNO 796	BOOL	TRUE			ALWAYS	TECHNICIAN		02131
0803	AR Trip Mask 2.39 A7	Same as PNO 796	BOOL	TRUE			ALWAYS	TECHNICIAN		02133
0804	AR Trip Mask 2.40 A8	Same as PNO 796	BOOL	TRUE			ALWAYS	TECHNICIAN		02135
0805	AR Trip Mask 2.41 SPEED ERROR	Same as PNO 796	BOOL	TRUE			ALWAYS	TECHNICIAN		02137
0806	AR Trip Mask 2.42 PEERTOPEER OVERRUN	Same as PNO 796	BOOL	TRUE			ALWAYS	TECHNICIAN		02139
0807	AR Trip Mask 2.43 PHASE CONFIG	Same as PNO 796	BOOL	TRUE			ALWAYS	TECHNICIAN		02141
0808	AR Trip Mask 2.44 FIELDBUS BREAK	Same as PNO 796	BOOL	TRUE			ALWAYS	TECHNICIAN		02143
0815	AR Trip Mask 2.51 CPU USAGE	Same as PNO 796	BOOL	TRUE			ALWAYS	TECHNICIAN		02157
0829	Warnings 1 - 32	Monitor::Trips Parameters::Trips::Trips Status	DWORD (bitfield)		Same as PNO 763		NEVER	OPERATOR		02185
0830	Warnings 1 - 32.01 OVER VOLTAGE	Same as PNO 829	BOOL				NEVER	OPERATOR		02187
0831	Warnings 1 - 32.02 UNDER VOLTAGE	Same as PNO 829	BOOL				NEVER	OPERATOR		02189
0832	Warnings 1 - 32.03 OVER CURRENT	Same as PNO 829	BOOL				NEVER	OPERATOR		02191
0833	Warnings 1 - 32.04 STACK FAULT	Same as PNO 829	BOOL				NEVER	OPERATOR		02193
0834	Warnings 1 - 32.05 STACK OVER CURRENT	Same as PNO 829	BOOL				NEVER	OPERATOR		02195
0835	Warnings 1 - 32.06 CURRENT LIMIT	Same as PNO 829	BOOL				NEVER	OPERATOR		02197
0836	Warnings 1 - 32.07 MOTOR STALL	Same as PNO 829	BOOL				NEVER	OPERATOR		02199
0837	Warnings 1 - 32.08 INVERSE TIME	Same as PNO 829	BOOL				NEVER	OPERATOR		02201
0838	Warnings 1 - 32.09 MOTOR I2T	Same as PNO 829	BOOL				NEVER	OPERATOR		02203
0839	Warnings 1 - 32.10 LOW SPEED I	Same as PNO 829	BOOL				NEVER	OPERATOR		02205
0840	Warnings 1 - 32.11 HEATSINK OVERTEMP	Same as PNO 829	BOOL				NEVER	OPERATOR		02207
0841	Warnings 1 - 32.12 INTERNAL OVERTEMP	Same as PNO 829	BOOL				NEVER	OPERATOR		02209
0842	Warnings 1 - 32.13 MOTOR OVERTEMP	Same as PNO 829	BOOL				NEVER	OPERATOR		02211
0843	Warnings 1 - 32.14 EXTERNAL TRIP	Same as PNO 829	BOOL				NEVER	OPERATOR		02213
0844	Warnings 1 - 32.15 BRAKE SHORT CCT	Same as PNO 829	BOOL				NEVER	OPERATOR		02215
0845	Warnings 1 - 32.16 BRAKE RESISTOR	Same as PNO 829	BOOL				NEVER	OPERATOR		02217
0846	Warnings 1 - 32.17 BRAKE SWITCH	Same as PNO 829	BOOL				NEVER	OPERATOR		02219
0847	Warnings 1 - 32.18 LOCAL CONTROL	Same as PNO 829	BOOL				NEVER	OPERATOR		02221
0848	Warnings 1 - 32.19 COMMS BREAK	Same as PNO 829	BOOL				NEVER	OPERATOR		02223
0849	Warnings 1 - 32.20 LINE CONTACTOR	Same as PNO 829	BOOL				NEVER	OPERATOR		02225
0850	Warnings 1 - 32.21 PHASE FAIL	Same as PNO 829	BOOL				NEVER	OPERATOR		02227
0851	Warnings 1 - 32.22 VDC RIPPLE	Same as PNO 829	BOOL				NEVER	OPERATOR		02229
0852	Warnings 1 - 32.23 BASE MODBUS BREAK	Same as PNO 829	BOOL				NEVER	OPERATOR		02231
0853	Warnings 1 - 32.24 24 V OVERLOAD	Same as PNO 829	BOOL				NEVER	OPERATOR		02233
0854	Warnings 1 - 32.25 PMAC SPEED ERROR	Same as PNO 829	BOOL				NEVER	OPERATOR		02235
0855	Warnings 1 - 32.26 OVERSPEED	Same as PNO 829	BOOL				NEVER	OPERATOR		02237
0856	Warnings 1 - 32.27 STO ACTIVE	Same as PNO 829	BOOL				NEVER	OPERATOR		02239
0857	Warnings 1 - 32.28 FEEDBACK MISSING	Same as PNO 829	BOOL				NEVER	OPERATOR		02241
0858	Warnings 1 - 32.29 INTERNAL FAN FAIL	Same as PNO 829	BOOL				NEVER	OPERATOR		02243
0859	Warnings 1 - 32.30 CURRENT SENSOR	Same as PNO 829	BOOL				NEVER	OPERATOR		02245
0860	Warnings 1 - 32.31 POWER LOSS STOP	Same as PNO 829	BOOL				NEVER	OPERATOR		02247

C-246 Parameter Reference

PNO	Name	Path	Type	Default	Range	Units	WQ	View	Notes	Mbus
0861	Warnings 1 - 32.32 SPEED SENSOR	Same as PNO 829	BOOL				NEVER	OPERATOR		02249
0890	Maintenance Warnings	Parameters::Trips::Maintenance Monitor	WORD				NEVER	OPERATOR		02307
0891	Maintenance Reporting	Parameters::Trips::Maintenance Monitor	WORD	FFFF			ALWAYS	TECHNICIAN		02309
0892	Maintenance Reset	Parameters::Trips::Maintenance Monitor	WORD	0000			ALWAYS	ENGINEER	2	02311
0893	Ambient Temperature	Parameters::Trips::Maintenance Monitor	REAL	25.0	-20.0 to 70.0	°C	ALWAYS	TECHNICIAN		02313
0894	IM Wiring	Parameters::Motor Control::Induction Motor Data	BOOL	FALSE			STOPPED	OPERATOR	6	02315
0895	Recent Trips	Parameters::Trips::Trips History	ARRAY[0..9]				NEVER	OPERATOR		02317
0896	Recent Trips[0]	Parameters::Trips::Trips History	USINT (enum)		Same as PNO 696		NEVER	OPERATOR	1	02319
0897	Recent Trips[1]	Parameters::Trips::Trips History	USINT (enum)		Same as PNO 696		NEVER	OPERATOR	1	02321
0898	Recent Trips[2]	Parameters::Trips::Trips History	USINT (enum)		Same as PNO 696		NEVER	OPERATOR	1	02323
0899	Recent Trips[3]	Parameters::Trips::Trips History	USINT (enum)		Same as PNO 696		NEVER	OPERATOR	1	02325
0900	Recent Trips[4]	Parameters::Trips::Trips History	USINT (enum)		Same as PNO 696		NEVER	OPERATOR	1	02327
0901	Recent Trips[5]	Parameters::Trips::Trips History	USINT (enum)		Same as PNO 696		NEVER	OPERATOR	1	02329
0902	Recent Trips[6]	Parameters::Trips::Trips History	USINT (enum)		Same as PNO 696		NEVER	OPERATOR	1	02331
0903	Recent Trips[7]	Parameters::Trips::Trips History	USINT (enum)		Same as PNO 696		NEVER	OPERATOR	1	02333
0904	Recent Trips[8]	Parameters::Trips::Trips History	USINT (enum)		Same as PNO 696		NEVER	OPERATOR	1	02335
0905	Recent Trips[9]	Parameters::Trips::Trips History	USINT (enum)		Same as PNO 696		NEVER	OPERATOR	1	02337
0906	Stall Limit Type	Parameters::Trips::Stall Trip	USINT (enum)	2	0:TORQUE 1:CURRENT 2:TORQUE OR CURRENT		ALWAYS	TECHNICIAN		02339
0907	Stall Time	Parameters::Trips::Stall Trip	TIME	90.000	0.100 to 2000.000	s	ALWAYS	TECHNICIAN	6	02341
0908	Control Screen Mode	Parameters::Device Manager::Soft Menus	USINT (enum)	1	0:DISABLED 1:AUTO 2:CUSTOM		STOPPED	ENGINEER		02343
0909	Stall Torque Active	Parameters::Trips::Stall Trip	BOOL				NEVER	TECHNICIAN		02345
0910	Stall Current Active	Parameters::Trips::Stall Trip	BOOL				NEVER	TECHNICIAN		02347
0911	Stall Speed Feedback	Parameters::Trips::Stall Trip	REAL	x.	-200 to 200	%	NEVER	ENGINEER		02349
0912	VDC Ripple Filter TC	Parameters::Trips::VDC Ripple	TIME	1.000	0.100 to 100.000	s	ALWAYS	ENGINEER		02351
0913	Max VDC Ripple	Parameters::Trips::VDC Ripple	REAL	x.	0 to 500	V	NEVER	ENGINEER		02353
0914	VDC Ripple Trip Delay	Parameters::Trips::VDC Ripple	TIME		0.000 to 300.000	s	NEVER	ENGINEER		02355
0915	VDC Ripple Trip Hyst	Parameters::Trips::VDC Ripple	REAL	10	0 to 50	V	ALWAYS	ENGINEER		02357
0916	VDC Ripple Sample	Parameters::Trips::VDC Ripple	TIME	0.009	0.001 to 0.100	s	ALWAYS	ENGINEER		02359
0917	VDC Ripple Level	Parameters::Trips::VDC Ripple	REAL	x.	0 to 500	V	NEVER	ENGINEER		02361
0918	Filtered VDC Ripple	Parameters::Trips::VDC Ripple	REAL	x.	0 to 500	V	NEVER	ENGINEER		02363
0919	Ethernet State	Monitor::Communications::Base Ethernet Parameters::Base Comms::Ethernet	USINT (enum)		0:INITIALISING 1:NO LINK 2:RESOLVING IP 3:RESOLVING DHCP 4:RESOLVING AUTO 5:RESOLVED IP 6:STOPPING DHCP 7:DUPLICATE IP 8:FAULT		NEVER	OPERATOR		02365
0920	MAC Address	Same as PNO 919	STRING[17]				NEVER	OPERATOR		02367
0926	IP Address	Same as PNO 919	DWORD (IP addr)				NEVER	OPERATOR		02379
0927	Subnet Mask	Same as PNO 919	DWORD (IP addr)				NEVER	OPERATOR		02381
0928	Gateway Address	Same as PNO 919	DWORD (IP addr)				NEVER	OPERATOR		02383
0929	DHCP	Setup::Communications::Base Ethernet Parameters::Base Comms::Ethernet	BOOL	TRUE			ALWAYS	TECHNICIAN		02385
0930	Auto IP	Same as PNO 929	BOOL	TRUE			ALWAYS	TECHNICIAN		02387
0931	Last Auto IP Address	Parameters::Base Comms::Ethernet	DWORD (IP addr)				NEVER	ENGINEER	3	02389
0933	User IP Address	Same as PNO 929	DWORD	000.000.000.000			ALWAYS	TECHNICIAN	7,4	02393

Parameter Reference C-247

PNO	Name	Path	Type	Default	Range	Units	WQ	View	Notes	Mbus
0934	User Subnet Mask	Same as PNO 929	(IP addr) DWORD (IP addr)	000.000.000.000			ALWAYS	TECHNICIAN	7,4	02395
0935	User Gateway Address	Same as PNO 929	DWORD (IP addr)	000.000.000.000			ALWAYS	TECHNICIAN	7,4	02397
0936	Lock	Parameters::Base Comms::Ethernet	BOOL	FALSE			ALWAYS	ENGINEER		02399
0937	Ethernet Diagnostic	Parameters::Base Comms::Ethernet	DWORD				NEVER	ENGINEER		02401
0938	Free Packets	Parameters::Base Comms::Ethernet	UDINT		0 to 100		NEVER	ENGINEER		02403
0939	Maximum Connections	Setup::Communications::Base Modbus Parameters::Base Comms::Modbus	USINT	0	0 to 3		ALWAYS	TECHNICIAN		02405
0940	High Word First	Same as PNO 939	BOOL	FALSE			ALWAYS	TECHNICIAN		02407
0941	Modbus Timeout	Same as PNO 939	TIME	3.000	0.000 to 65.000	s	ALWAYS	TECHNICIAN		02409
0942	Modbus Trip Enable	Same as PNO 939	BOOL	TRUE			ALWAYS	TECHNICIAN		02411
0943	Process Active	Monitor::Communications::Base Modbus Parameters::Base Comms::Modbus	BOOL				NEVER	OPERATOR		02413
0944	Web Access	Setup::Communications::Base Ethernet Setup::Environment Parameters::Base Comms::Web Server	USINT (enum)	1	0:DISABLED 1:LIMITED 2:FULL		ALWAYS	TECHNICIAN		02415
0945	Web View Level	Parameters::Base Comms::Web Server	USINT (enum)	1	0:OPERATOR 1:TECHNICIAN 2:ENGINEER		ALWAYS	OPERATOR		02417
0946	Web Password	Parameters::Base Comms::Web Server	STRING[16]				ALWAYS	ENGINEER		02419
0951	Boot Version	Parameters::Device Manager::Drive info	STRING[7]				NEVER	ENGINEER		02429
0955	Enable Predict Term	Parameters::Motor Control::Current Loop	BOOL	TRUE			ALWAYS	ENGINEER	4	02437
0957	Anin 01 Offset	Setup::Inputs and Outputs::Base IO Parameters::Inputs And Outputs::IO Configure	REAL	0.00	Min to Max	%	ALWAYS	OPERATOR		02441
0958	Anin 01 Scale	Same as PNO 957	REAL	1.0000	Min to Max		ALWAYS	OPERATOR		02443
0959	Anin 02 Offset	Same as PNO 957	REAL	0.00	Min to Max	%	ALWAYS	OPERATOR		02445
0960	Anin 02 Scale	Same as PNO 957	REAL	1.0000	Min to Max		ALWAYS	OPERATOR		02447
0961	Drive Name	Setup::Environment Parameters::Device Manager::Drive info	STRING[23]				ALWAYS	TECHNICIAN	7	02449
0968	Warranty Trips	Parameters::Trips::Trips History	ARRAY[0..2]				NEVER	ENGINEER		02463
0969	Warranty Trips[0]	Parameters::Trips::Trips History	USINT (enum)		Same as PNO 696		NEVER	ENGINEER	1	02465
0970	Warranty Trips[1]	Parameters::Trips::Trips History	USINT (enum)		Same as PNO 696		NEVER	ENGINEER	1	02467
0971	Warranty Trips[2]	Parameters::Trips::Trips History	USINT (enum)		Same as PNO 696		NEVER	ENGINEER	1	02469
0972	Warranty Trip Time	Parameters::Trips::Trips History	ARRAY[0..2]				NEVER	ENGINEER		02471
0973	Warranty Trip Time[0]	Parameters::Trips::Trips History	UDINT		0 to Max	s	NEVER	ENGINEER	1	02473
0974	Warranty Trip Time[1]	Parameters::Trips::Trips History	UDINT		0 to Max	s	NEVER	ENGINEER	1	02475
0975	Warranty Trip Time[2]	Parameters::Trips::Trips History	UDINT		0 to Max	s	NEVER	ENGINEER	1	02477
0976	Nominal Supply	Parameters::Device Manager::Drive info	USINT (enum)	0	0:50 Hz 1:60 Hz		STOPPED	ENGINEER	6	02479
0977	Control Module Serial	Parameters::Device Manager::Drive info	STRING[15]				NEVER	OPERATOR		02481
0982	Startup Page	Setup::Environment Parameters::Keypad::Graphical Keypad	DWORD	80000000			ALWAYS	TECHNICIAN		02491
0983	Display Timeout	Same as PNO 982	TIME	0.000	0.000 to 86400.000	s	ALWAYS	TECHNICIAN		02493
0987	Power Stack Required	Parameters::Device Manager::Drive info	USINT (enum)	0	Same as PNO 543		CONFIG	ENGINEER	6	02501
0988	Target State	Parameters::Device Manager::Device State	USINT (enum)	3	3:PREOPERATIONAL 7:OPERATIONAL		STOPPED	OPERATOR	2	02503
0989	Actual State	Parameters::Device Manager::Device State	USINT (enum)		0:INITIALISING 1:INITIALISED 2:PREPARING PREOP 3:PREOPERATIONAL 4:PREPARING OP 5:FAILED TO READY 6:READY FOR OP 7:OPERATIONAL 8:FAULTED 9:FATAL ERROR RECOVER		NEVER	OPERATOR		02505
0990	Application FE State	Parameters::Device Manager::Device State	USINT (enum)		Same as PNO 989		NEVER	OPERATOR		02507
0991	Base IO FE State	Parameters::Device Manager::Device State	USINT (enum)		Same as PNO 989		NEVER	OPERATOR		02509
0992	Basic Drive FE State	Parameters::Device Manager::Device State	USINT		Same as PNO 989		NEVER	OPERATOR		02511

C-248 Parameter Reference

PNO	Name	Path	Type	Default	Range	Units	WQ	View	Notes	MBus
0993	Ethernet FE State	Parameters::Device Manager::Device State	(enum) USINT (enum)		Same as PNO 989		NEVER	OPERATOR		02513
0994	Keypad FE State	Parameters::Device Manager::Device State	USINT (enum)		Same as PNO 989		NEVER	OPERATOR		02515
0995	Comms Option FE State	Parameters::Device Manager::Device State	USINT (enum)		Same as PNO 989		NEVER	OPERATOR		02517
0996	IO Option FE State	Parameters::Device Manager::Device State	USINT (enum)		Same as PNO 989		NEVER	OPERATOR		02519
0997	Config Fault Area	Parameters::Device Manager::Device State	USINT (enum)		0:NONE 1:POWER STACK 2:OPTION IO 3:OPTION COMMS 4:APPLICATION 5:MOTOR CONTROL 6:KEYPAD 7:BASE COMMS 8:BASE IO 9:FEEDBACK MISSING 10:SYSTEM BOARD		NEVER	OPERATOR		02521
0998	RTA Code	Monitor::Trips Parameters::Device Manager::Device State	UINT		0 to 65535		NEVER	OPERATOR	4	02523
0999	RTA Data	Same as PNO 998	DWORD				NEVER	OPERATOR	4	02525
1000	Reset to Defaults	Parameters::Device Manager::Device Commands	BOOL	FALSE			CONFIG	TECHNICIAN	2	02527
1001	Save All Parameters	Parameters::Device Manager::Device Commands	BOOL	FALSE			ALWAYS	OPERATOR	2	02529
1002	Update Firmware	Parameters::Device Manager::Device Commands	BOOL	FALSE			STOPPED	TECHNICIAN	2,4	02531
1003	RTA Thread Priority	Parameters::Device Manager::Device State	SINT		-128 to 127		NEVER	OPERATOR	4	02533
1004	Thermistor Trip Level	Parameters::Option IO::Thermistor	REAL	1000	0 to 4500	Ohm	ALWAYS	TECHNICIAN	4	02535
1005	Language	Parameters::Device Manager::Setup Wizard	USINT (enum)	0	0:ENGLISH 1:FRANCAIS 2:DEUTSCH 3:ESPANOL 4:ITALIANO 5:CHINESE 6:L 6 7:L 7 8:L 8 9:L 9		STOPPED	TECHNICIAN		02537
1006	Run Wizard?	Parameters::Device Manager::Setup Wizard	USINT (enum)	1	0:NO 1:YES		ALWAYS	TECHNICIAN	4	02539
1033	Card State	Parameters::Device Manager::SD Card	USINT (enum)		0:NO CARD 1:INITIALISING 2:READY 3:CARD FAULT		NEVER	OPERATOR		02593
1034	Card Name	Parameters::Device Manager::SD Card	STRING[11]				NEVER	OPERATOR		02595
1038	Firmware	Parameters::Device Manager::SD Card	BOOL				NEVER	OPERATOR		02603
1039	Application Archive	Parameters::Device Manager::SD Card	BOOL				NEVER	OPERATOR		02605
1040	Project File Name	Parameters::Application::App Info	STRING[23]				NEVER	TECHNICIAN		02607
1047	Last Modification	Parameters::Application::App Info	DT		1970/01/01 to 2038/01/19		NEVER	TECHNICIAN		02621
1048	IDE Version	Parameters::Application::App Info	STRING[20]				NEVER	TECHNICIAN		02623
1054	Project Author	Parameters::Application::App Info	STRING[23]				NEVER	TECHNICIAN		02635
1061	Project Version	Parameters::Application::App Info	STRING[23]				NEVER	TECHNICIAN		02649
1068	Project Description	Parameters::Application::App Info	STRING[80]				NEVER	TECHNICIAN		02663
1089	BACnet MSTP State	Monitor::Communications::Option Parameters::Option Comms::BACnet MSTP	USINT (enum)		Same as PNO 46		NEVER	OPERATOR	4	02705
1091	BACnet MAC Address	Setup::Communications::Option Parameters::Option Comms::BACnet MSTP	USINT	0	0 to 127		CONFIG	TECHNICIAN	7,4	02709
1092	BACnet MSTP Device ID	Same as PNO 1091	UDINT	0	0 to 4194302		CONFIG	TECHNICIAN	7,4	02711
1093	BACnet Baud Rate	Same as PNO 1091	USINT (enum)	0	0:9600 BPS 1:19200 BPS 2:38400 BPS 3:76800 BPS		CONFIG	TECHNICIAN	4	02713
1094	BACnet MSTP Timeout	Same as PNO 1091	TIME	3.000	0.000 to 65.000	s	CONFIG	TECHNICIAN	4	02715
1095	BACnet Max Master	Same as PNO 1091	USINT	127	1 to 127		CONFIG	ENGINEER	4	02717
1096	BACnet Max Info Frames	Same as PNO 1091	USINT	1	1 to 255		CONFIG	ENGINEER	4	02719

Parameter Reference C-249

PNO	Name	Path	Type	Default	Range	Units	WQ	View	Notes	Mbus
1097	Password in Favourite	Parameters::Keypad::Graphical Keypad	BOOL	FALSE			ALWAYS	TECHNICIAN		02721
1098	Password in Local	Parameters::Keypad::Graphical Keypad	BOOL	FALSE			ALWAYS	TECHNICIAN		02723
1099	Technician Password	Parameters::Keypad::Graphical Keypad	WORD	0000			ALWAYS	OPERATOR		02725
1100	Firmware Version	Parameters::Device Manager::Drive info	STRING[21]				NEVER	OPERATOR		02727
1108	Anout 01 Offset	Setup::Inputs and Outputs::Base IO Parameters::Inputs And Outputs::IO Configure	REAL	0.00	Min to Max	%	ALWAYS	OPERATOR		02743
1109	Stack Pcode	Parameters::Device Manager::Drive info	STRING[23]				NEVER	OPERATOR		02745
1116	Control Module Pcode	Parameters::Device Manager::Drive info	STRING[15]				NEVER	OPERATOR		02759
1121	Comms Option Pcode	Parameters::Device Manager::Drive info	STRING[11]				NEVER	OPERATOR	4	02769
1125	IO Option Pcode	Parameters::Device Manager::Drive info	STRING[11]				NEVER	OPERATOR	4	02777
1129	Comms Option Serial	Parameters::Device Manager::Drive info	STRING[15]				NEVER	OPERATOR	4	02785
1134	IO Option Serial No	Parameters::Device Manager::Drive info	STRING[15]				NEVER	OPERATOR	4	02795
1139	Control Board Up Time	Parameters::Device Manager::Runtime Statistics	UDINT		0 to Max	s	NEVER	OPERATOR	1	02805
1140	Run Key Action	Parameters::Keypad::Local Control	USINT (enum)	0	0:RUN 1:JOG		STOPPED	OPERATOR	4	02807
1141	View Level	Parameters::Keypad::Graphical Keypad	USINT (enum)	1	Same as PNO 945		ALWAYS	OPERATOR		02809
1142	GKP Password	Setup::Environment Parameters::Keypad::Graphical Keypad	WORD	0000			ALWAYS	TECHNICIAN		02811
1143	Version	Parameters::Keypad::Graphical Keypad	WORD				NEVER	OPERATOR		02813
1178	Option IO Required	Setup::Inputs and Outputs::Option Parameters::Option IO::Option IO	USINT (enum)	0	0:NONE 1:GENERAL PURPOSE 2:THERMISTOR 3:RTC AND THERMISTOR 4:PULSE ENCODER 5:RESOLVER AND THERMIST		STOPPED	TECHNICIAN		02883
1179	Option IO Fitted	Parameters::Option IO::Option IO	USINT (enum)		Same as PNO 1178		NEVER	OPERATOR	1	02885
1180	Option IO Diagnostic	Parameters::Option IO::Option IO	USINT (enum)		0:OK 1:OPTION NOT FITTED 2:TYPE MISMATCH 3:TYPE UNKNOWN 4:HARDWARE FAULT		NEVER	OPERATOR		02887
1181	Anin 11 Value	Monitor::Inputs and Outputs Parameters::Option IO::General Purpose IO	REAL	x.xx	-100.00 to 100.00	%	NEVER	OPERATOR	4	02889
1182	Anin 12 Value	Same as PNO 1181	REAL	x.xx	-100.00 to 100.00	%	NEVER	OPERATOR	4	02891
1183	Anin 13 Value	Same as PNO 1181	REAL	x.xx	-100.00 to 100.00	%	NEVER	OPERATOR	4	02893
1184	Thermistor Type	Setup::Inputs and Outputs::Option Parameters::Option IO::Thermistor	USINT (enum)	1	0:NTC 1:PTC 2:KTY		ALWAYS	TECHNICIAN	4	02895
1185	Thermistor Resistance	Parameters::Option IO::Thermistor	REAL	x.	0 to 5000	Ohm	NEVER	TECHNICIAN	4	02897
1186	Time and Date	Parameters::Device Manager::Real Time Clock	DT	1970/01/01	1970/01/01 to 2038/01/19		ALWAYS	OPERATOR	2	02899
1187	RTC Trim	Parameters::Option IO::General Purpose IO	SINT	0	-40 to 40		ALWAYS	ENGINEER	2,4	02901
1188	Favourites	Parameters::Device Manager::Soft Menus	ARRAY[0..19]				ALWAYS	OPERATOR		02903
1189	Favourites[0]	Favourites Parameters::Device Manager::Soft Menus	UINT	0000	0000 to 3145		ALWAYS	OPERATOR		02905
1190	Favourites[1]	Same as PNO 1189	UINT	0000	0000 to 3145		ALWAYS	OPERATOR		02907
1191	Favourites[2]	Same as PNO 1189	UINT	0000	0000 to 3145		ALWAYS	OPERATOR		02909
1192	Favourites[3]	Same as PNO 1189	UINT	0000	0000 to 3145		ALWAYS	OPERATOR		02911
1193	Favourites[4]	Same as PNO 1189	UINT	0000	0000 to 3145		ALWAYS	OPERATOR		02913
1194	Favourites[5]	Same as PNO 1189	UINT	0000	0000 to 3145		ALWAYS	OPERATOR		02915
1195	Favourites[6]	Same as PNO 1189	UINT	0000	0000 to 3145		ALWAYS	OPERATOR		02917
1196	Favourites[7]	Same as PNO 1189	UINT	0000	0000 to 3145		ALWAYS	OPERATOR		02919
1197	Favourites[8]	Same as PNO 1189	UINT	0000	0000 to 3145		ALWAYS	OPERATOR		02921
1198	Favourites[9]	Same as PNO 1189	UINT	0000	0000 to 3145		ALWAYS	OPERATOR		02923
1199	Favourites[10]	Same as PNO 1189	UINT	0000	0000 to 3145		ALWAYS	OPERATOR		02925
1200	Favourites[11]	Same as PNO 1189	UINT	0000	0000 to 3145		ALWAYS	OPERATOR		02927
1201	Favourites[12]	Same as PNO 1189	UINT	0000	0000 to 3145		ALWAYS	OPERATOR		02929
1202	Favourites[13]	Same as PNO 1189	UINT	0000	0000 to 3145		ALWAYS	OPERATOR		02931
1203	Favourites[14]	Same as PNO 1189	UINT	0000	0000 to 3145		ALWAYS	OPERATOR		02933
1204	Favourites[15]	Same as PNO 1189	UINT	0000	0000 to 3145		ALWAYS	OPERATOR		02935
1205	Favourites[16]	Same as PNO 1189	UINT	0000	0000 to 3145		ALWAYS	OPERATOR		02937
1206	Favourites[17]	Same as PNO 1189	UINT	0000	0000 to 3145		ALWAYS	OPERATOR		02939
1207	Favourites[18]	Same as PNO 1189	UINT	0000	0000 to 3145		ALWAYS	OPERATOR		02941
1208	Favourites[19]	Same as PNO 1189	UINT	0000	0000 to 3145		ALWAYS	OPERATOR		02943
1213	Actual Position	Monitor::Motor and Drive	REAL	x.x	-180.0 to 180.0	deg	NEVER	TECHNICIAN	4	02953

C-250 Parameter Reference

PNO	Name	Path	Type	Default	Range	Units	WQ	View	Notes	MBus
1214	Automatic Pole Pairs	Parameters::Motor Control::Feedbacks	BOOL	TRUE			ALWAYS	TECHNICIAN	4	02955
1225	DST Active	Parameters::Device Manager::Real Time Clock	BOOL	FALSE			ALWAYS	OPERATOR		02977
1228	Time Zone Offset	Parameters::Device Manager::Real Time Clock	REAL	0.00	-14.00 to 14.00		ALWAYS	OPERATOR		02983
1229	Mechanical Offset	Parameters::System Board::SB Encoder	DINT		Min to Max		NEVER	ENGINEER	1,4	02985
1230	Motor Position	Parameters::System Board::SB Encoder	REAL	x.xx	-180.00 to 180.00	deg	NEVER	TECHNICIAN	1,4	02987
1231	Enc To Mot Shaft Ratio	Setup::Inputs and Outputs::SB Encoder Parameters::System Board::SB Encoder	INT	1,	1 to 50		STOPPED	TECHNICIAN	4	02989
1232	Encoder Status	Parameters::System Board::SB Encoder	USINT (enum)		0:OK 1:SIN COS ISSUE 2:OK WITH COMMS WARNING 3:COMMS ERROR 4:CALIB IN PROGRESS 5:CALIB ERROR 6:NOT DETECTED		NEVER	TECHNICIAN	4	02991
1235	Endat Comms Status	Parameters::System Board::SB Encoder	USINT (enum)		0:NOT SUPPORTED 1:WORKING 2:CHECKSUM 3:BIT WARNING 4:TIMEOUT 5:ERROR		NEVER	ENGINEER	4	02997
1239	Local Run Key Active	Parameters::Keypad::Local Control	BOOL	TRUE			ALWAYS	TECHNICIAN		03005
1240	Local Reverse	Parameters::Keypad::Local Control	BOOL	FALSE			ALWAYS	OPERATOR	1,4	03007
1241	Open Connections	Monitor::Communications::Base Modbus Parameters::Base Comms::Modbus	USINT		0 to 255		NEVER	OPERATOR		03009
1246	Speed Loop Auto Set	Parameters::Motor Control::Spd Loop Settings	BOOL	TRUE			ALWAYS	TECHNICIAN	4	03019
1247	Ratio Load Mot Inert	Parameters::Motor Control::Spd Loop Settings	REAL	1.0	0.1 to 100.0		ALWAYS	TECHNICIAN	4	03021
1248	Speed Loop Bandwidth	Parameters::Motor Control::Spd Loop Settings	USINT (enum)	1	0:LOW 1:MEDIUM 2:HIGH		ALWAYS	TECHNICIAN	4	03023
1251	CANopen Actual Baud	Monitor::Communications::Option Parameters::Option Comms::CANopen	USINT (enum)		Same as PNO 213		NEVER	OPERATOR	4	03029
1252	HV SMPS Up Time	Parameters::Device Manager::Runtime Statistics	UDINT		0 to Max	s	NEVER	TECHNICIAN	1	03031
1253	Local/Rem Key Active	Parameters::Keypad::Local Control	BOOL	TRUE			ALWAYS	TECHNICIAN		03033
1254	IO Option SW Version	Parameters::Device Manager::Drive info	WORD				NEVER	OPERATOR	4	03035
1255	Local Dir Key Active	Parameters::Keypad::Local Control	BOOL	TRUE			ALWAYS	TECHNICIAN		03037
1256	OEM ID	Parameters::Device Manager::Drive info	UINT		0 to 65535		NEVER	ENGINEER		03039
1257	Seq Stop Method SVC	Setup::Motor Control::Control and Type Parameters::Motor Control::Ramp	USINT (enum)	1	0:DISABLED VOLTAGE 1:RAMP 2:STOP RAMP		ALWAYS	TECHNICIAN	4	03041
1258	Stack Serial No	Parameters::Device Manager::Drive info	STRING[15]				NEVER	OPERATOR		03043
1264	Min Speed Clamp	Parameters::Motor Control::Speed Ref	REAL	-110.00	-110.00 to 0.00	%	ALWAYS	OPERATOR		03055
1265	Max Speed Clamp	Parameters::Motor Control::Speed Ref	REAL	110.00	0.00 to 110.00	%	ALWAYS	OPERATOR		03057
1266	Speed Trim	Parameters::Motor Control::Speed Ref	REAL	0.00	-300.00 to 300.00	%	ALWAYS	OPERATOR		03059
1267	Trim in Local	Parameters::Motor Control::Speed Ref	BOOL	FALSE			ALWAYS	OPERATOR		03061
1268	Random Pattern PMAC	Parameters::Motor Control::Pattern Generator	BOOL	FALSE			ALWAYS	ENGINEER	4	03063
1269	DHCP State	Parameters::Base Comms::Ethernet	DWORD				NEVER	ENGINEER		03065
1270	Monitor	Parameters::Device Manager::Soft Menus	ARRAY[0..19]				ALWAYS	OPERATOR		03067
1271	Monitor[0]	Monitor::Quick Monitor Parameters::Device Manager::Soft Menus	UINT	0383	0000 to 3145		ALWAYS	OPERATOR	2	03069
1272	Monitor[1]	Same as PNO 1271	UINT	0393	0000 to 3145		ALWAYS	OPERATOR	2	03071
1273	Monitor[2]	Same as PNO 1271	UINT	0395	0000 to 3145		ALWAYS	OPERATOR	2	03073
1274	Monitor[3]	Same as PNO 1271	UINT	0696	0000 to 3145		ALWAYS	OPERATOR	2	03075
1275	Monitor[4]	Same as PNO 1271	UINT	0895	0000 to 3145		ALWAYS	OPERATOR	2	03077
1276	Monitor[5]	Same as PNO 1271	UINT	0926	0000 to 3145		ALWAYS	OPERATOR	2	03079
1277	Monitor[6]	Same as PNO 1271	UINT	0000	0000 to 3145		ALWAYS	OPERATOR	2	03081
1278	Monitor[7]	Same as PNO 1271	UINT	0000	0000 to 3145		ALWAYS	OPERATOR	2	03083
1279	Monitor[8]	Same as PNO 1271	UINT	0000	0000 to 3145		ALWAYS	OPERATOR	2	03085
1280	Monitor[9]	Same as PNO 1271	UINT	0000	0000 to 3145		ALWAYS	OPERATOR	2	03087
1281	Monitor[10]	Same as PNO 1271	UINT	0000	0000 to 3145		ALWAYS	OPERATOR	2	03089
1282	Monitor[11]	Same as PNO 1271	UINT	0000	0000 to 3145		ALWAYS	OPERATOR	2	03091
1283	Monitor[12]	Same as PNO 1271	UINT	0000	0000 to 3145		ALWAYS	OPERATOR	2	03093
1284	Monitor[13]	Same as PNO 1271	UINT	0000	0000 to 3145		ALWAYS	OPERATOR	2	03095
1285	Monitor[14]	Same as PNO 1271	UINT	0000	0000 to 3145		ALWAYS	OPERATOR	2	03097
1286	Monitor[15]	Same as PNO 1271	UINT	0000	0000 to 3145		ALWAYS	OPERATOR	2	03099

Parameter Reference C-251

PNO	Name	Path	Type	Default	Range	Units	WQ	View	Notes	Mbus
1287	Monitor[16]	Same as PNO 1271	UINT	0000	0000 to 3145		ALWAYS	OPERATOR	2	03101
1288	Monitor[17]	Same as PNO 1271	UINT	0000	0000 to 3145		ALWAYS	OPERATOR	2	03103
1289	Monitor[18]	Same as PNO 1271	UINT	0000	0000 to 3145		ALWAYS	OPERATOR	2	03105
1290	Monitor[19]	Same as PNO 1271	UINT	0000	0000 to 3145		ALWAYS	OPERATOR	2	03107
1291	Output A Invert	Parameters::System Board::SB Retransmit	BOOL	FALSE			ALWAYS	TECHNICIAN	4	03109
1292	Output B Invert	Parameters::System Board::SB Retransmit	BOOL	FALSE			ALWAYS	TECHNICIAN	4	03111
1293	Output Z Invert	Parameters::System Board::SB Retransmit	BOOL	FALSE			ALWAYS	TECHNICIAN	4	03113
1294	Digin Invert	Setup::Inputs and Outputs::Base IO Parameters::Inputs And Outputs::IO Configure	WORD (bitfield)	0000	0:Inv Digin 01 1:Inv Digin 02 2:Inv Digin 03 3:Inv Digin 04 4:Inv Digin 05 5:Inv Digin 06 6:Inv Digin 07 7:Inv STO Inactive 8:Inv Digin 11 9:Inv Digin 12 10:Inv Digin 13 11:Inv Digin 14 12:Inv Run Key 13:Inv Not Stop Key 14:Inv Stop Key		ALWAYS	OPERATOR		03115
1295	Digin Invert.Inv Digin 01	Same as PNO 1294	BOOL	FALSE			ALWAYS	OPERATOR		03117
1296	Digin Invert.Inv Digin 02	Same as PNO 1294	BOOL	FALSE			ALWAYS	OPERATOR		03119
1297	Digin Invert.Inv Digin 03	Same as PNO 1294	BOOL	FALSE			ALWAYS	OPERATOR		03121
1298	Digin Invert.Inv Digin 04	Same as PNO 1294	BOOL	FALSE			ALWAYS	OPERATOR		03123
1299	Digin Invert.Inv Digin 05	Same as PNO 1294	BOOL	FALSE			ALWAYS	OPERATOR		03125
1300	Digin Invert.Inv Digin 06	Same as PNO 1294	BOOL	FALSE			ALWAYS	OPERATOR		03127
1301	Digin Invert.Inv Digin 07	Same as PNO 1294	BOOL	FALSE			ALWAYS	OPERATOR		03129
1302	Digin Invert.Inv STO Inactive	Same as PNO 1294	BOOL	FALSE			ALWAYS	OPERATOR		03131
1303	Digin Invert.Inv Digin 11	Same as PNO 1294	BOOL	FALSE			ALWAYS	OPERATOR		03133
1304	Digin Invert.Inv Digin 12	Same as PNO 1294	BOOL	FALSE			ALWAYS	OPERATOR		03135
1305	Digin Invert.Inv Digin 13	Same as PNO 1294	BOOL	FALSE			ALWAYS	OPERATOR		03137
1306	Digin Invert.Inv Digin 14	Same as PNO 1294	BOOL	FALSE			ALWAYS	OPERATOR		03139
1307	Digin Invert.Inv Run Key	Same as PNO 1294	BOOL	FALSE			ALWAYS	OPERATOR		03141
1308	Digin Invert.Inv Not Stop Key	Same as PNO 1294	BOOL	FALSE			ALWAYS	OPERATOR		03143
1309	Digin Invert.Inv Stop Key	Same as PNO 1294	BOOL	FALSE			ALWAYS	OPERATOR		03145
1310	Encoder Position	Parameters::System Board::SB Encoder	REAL	x.xx	-180.00 to 180.00	deg	NEVER	TECHNICIAN	4	03147
1311	Setup	Parameters::Device Manager::Soft Menus	ARRAY[0..19]				ALWAYS	OPERATOR		03149
1312	Setup[0]	Setup::Quick Setup Parameters::Device Manager::Soft Menus	UINT	0000	0000 to 3145		ALWAYS	OPERATOR	2	03151
1313	Setup[1]	Same as PNO 1312	UINT	0000	0000 to 3145		ALWAYS	OPERATOR	2	03153
1314	Setup[2]	Same as PNO 1312	UINT	0000	0000 to 3145		ALWAYS	OPERATOR	2	03155
1315	Setup[3]	Same as PNO 1312	UINT	0000	0000 to 3145		ALWAYS	OPERATOR	2	03157
1316	Setup[4]	Same as PNO 1312	UINT	0000	0000 to 3145		ALWAYS	OPERATOR	2	03159
1317	Setup[5]	Same as PNO 1312	UINT	0000	0000 to 3145		ALWAYS	OPERATOR	2	03161
1318	Setup[6]	Same as PNO 1312	UINT	0000	0000 to 3145		ALWAYS	OPERATOR	2	03163
1319	Setup[7]	Same as PNO 1312	UINT	0000	0000 to 3145		ALWAYS	OPERATOR	2	03165
1320	Setup[8]	Same as PNO 1312	UINT	0000	0000 to 3145		ALWAYS	OPERATOR	2	03167
1321	Setup[9]	Same as PNO 1312	UINT	0000	0000 to 3145		ALWAYS	OPERATOR	2	03169
1322	Setup[10]	Same as PNO 1312	UINT	0000	0000 to 3145		ALWAYS	OPERATOR	2	03171
1323	Setup[11]	Same as PNO 1312	UINT	0000	0000 to 3145		ALWAYS	OPERATOR	2	03173
1324	Setup[12]	Same as PNO 1312	UINT	0000	0000 to 3145		ALWAYS	OPERATOR	2	03175
1325	Setup[13]	Same as PNO 1312	UINT	0000	0000 to 3145		ALWAYS	OPERATOR	2	03177
1326	Setup[14]	Same as PNO 1312	UINT	0000	0000 to 3145		ALWAYS	OPERATOR	2	03179
1327	Setup[15]	Same as PNO 1312	UINT	0000	0000 to 3145		ALWAYS	OPERATOR	2	03181
1328	Setup[16]	Same as PNO 1312	UINT	0000	0000 to 3145		ALWAYS	OPERATOR	2	03183
1329	Setup[17]	Same as PNO 1312	UINT	0000	0000 to 3145		ALWAYS	OPERATOR	2	03185
1330	Setup[18]	Same as PNO 1312	UINT	0000	0000 to 3145		ALWAYS	OPERATOR	2	03187
1331	Setup[19]	Same as PNO 1312	UINT	0000	0000 to 3145		ALWAYS	OPERATOR	2	03189
1332	SB Digital In 1 Invert	Parameters::System Board::SB Digital IO	BOOL	FALSE			ALWAYS	TECHNICIAN	4	03191
1333	SB Digital In 2 Invert	Parameters::System Board::SB Digital IO	BOOL	FALSE			ALWAYS	TECHNICIAN	4	03193
1334	SB Digital In 3 Invert	Parameters::System Board::SB Digital IO	BOOL	FALSE			ALWAYS	TECHNICIAN	4	03195
1335	Digout Invert	Setup::Inputs and Outputs::Base IO Parameters::Inputs And Outputs::IO Configure	WORD (bitfield)	0000	0:Inv Digout 01 1:Inv Digout 02 2:Inv Digout 03 3:Inv Digout 04		ALWAYS	OPERATOR		03197

C-252 Parameter Reference

PNO	Name	Path	Type	Default	Range	Units	WQ	View	Notes	Mbus
					4:Inv Relay 01 5:Inv Relay 02 8:Inv Digout 11 9:Inv Digout 12 10:Inv Digout 13 11:Inv Digout 14 14:Inv Relay 11 15:Inv Relay 12					
1336	Digout Invert.Inv Digout 01	Same as PNO 1335	BOOL	FALSE			ALWAYS	OPERATOR		03199
1337	Digout Invert.Inv Digout 02	Same as PNO 1335	BOOL	FALSE			ALWAYS	OPERATOR		03201
1338	Digout Invert.Inv Digout 03	Same as PNO 1335	BOOL	FALSE			ALWAYS	OPERATOR		03203
1339	Digout Invert.Inv Digout 04	Same as PNO 1335	BOOL	FALSE			ALWAYS	OPERATOR		03205
1340	Digout Invert.Inv Relay 01	Same as PNO 1335	BOOL	FALSE			ALWAYS	OPERATOR		03207
1341	Digout Invert.Inv Relay 02	Same as PNO 1335	BOOL	FALSE			ALWAYS	OPERATOR		03209
1344	Digout Invert.Inv Digout 11	Same as PNO 1335	BOOL	FALSE			ALWAYS	OPERATOR		03215
1345	Digout Invert.Inv Digout 12	Same as PNO 1335	BOOL	FALSE			ALWAYS	OPERATOR		03217
1346	Digout Invert.Inv Digout 13	Same as PNO 1335	BOOL	FALSE			ALWAYS	OPERATOR		03219
1347	Digout Invert.Inv Digout 14	Same as PNO 1335	BOOL	FALSE			ALWAYS	OPERATOR		03221
1350	Digout Invert.Inv Relay 11	Same as PNO 1335	BOOL	FALSE			ALWAYS	OPERATOR		03227
1351	Digout Invert.Inv Relay 12	Same as PNO 1335	BOOL	FALSE			ALWAYS	OPERATOR		03229
1352	Control Screen	Parameters::Device Manager::Soft Menus	ARRAY[0..5]				ALWAYS	OPERATOR		03231
1353	Control Screen[0]	Control Screen Parameters::Device Manager::Soft Menus	UINT	0000	0000 to 3145		ALWAYS	OPERATOR	2	03233
1354	Control Screen[1]	Same as PNO 1353	UINT	0000	0000 to 3145		ALWAYS	OPERATOR	2	03235
1355	Control Screen[2]	Same as PNO 1353	UINT	0000	0000 to 3145		ALWAYS	OPERATOR	2	03237
1356	Control Screen[3]	Same as PNO 1353	UINT	0000	0000 to 3145		ALWAYS	OPERATOR	2	03239
1357	Control Screen[4]	Same as PNO 1353	UINT	0000	0000 to 3145		ALWAYS	OPERATOR	2	03241
1358	Control Screen[5]	Same as PNO 1353	UINT	0000	0000 to 3145		ALWAYS	OPERATOR	2	03243
1364	Rotor Resistance	Parameters::Motor Control::Induction Motor Data	REAL	0.0000	-100.0000 to 100.0000	Ohm	ALWAYS	ENGINEER	6,9,4	03255
1365	SB Digital Input 4	Monitor::Inputs and Outputs Parameters::System Board::SB Digital IO	BOOL				NEVER	OPERATOR	4	03257
1366	SB Digital Input 5	Same as PNO 1365	BOOL				NEVER	OPERATOR	4	03259
1367	SB Digital Input 6	Same as PNO 1365	BOOL				NEVER	OPERATOR	4	03261
1368	SB Digital In 4 Invert	Parameters::System Board::SB Digital IO	BOOL	FALSE			ALWAYS	TECHNICIAN	4	03263
1369	SB Digital In 5 Invert	Parameters::System Board::SB Digital IO	BOOL	FALSE			ALWAYS	TECHNICIAN	4	03265
1370	SB Digital In 6 Invert	Parameters::System Board::SB Digital IO	BOOL	FALSE			ALWAYS	TECHNICIAN	4	03267
1371	SB Digital Output 1	Parameters::System Board::SB Digital IO	BOOL	FALSE			ALWAYS	OPERATOR	4	03269
1372	SB Digital Output 2	Parameters::System Board::SB Digital IO	BOOL	FALSE			ALWAYS	OPERATOR	4	03271
1373	SB Digital Output 3	Parameters::System Board::SB Digital IO	BOOL	FALSE			ALWAYS	OPERATOR	4	03273
1374	SB Dig Out 1 Invert	Parameters::System Board::SB Digital IO	BOOL	FALSE			ALWAYS	TECHNICIAN	4	03275
1375	SB Dig Out 2 Invert	Parameters::System Board::SB Digital IO	BOOL	FALSE			ALWAYS	TECHNICIAN	4	03277
1376	SB Dig Out 3 Invert	Parameters::System Board::SB Digital IO	BOOL	FALSE			ALWAYS	TECHNICIAN	4	03279
1386	Sntp Status	Parameters::Base Comms::Sntp Client	USINT (enum)		0:IDLE 1:UPDATING 2:OK 3:BIND ERROR 4:CONNECT ERROR 5:TRANSMIT ERROR 6:RECEIVE ERROR 7:RECEIVE TIMEOUT		NEVER	TECHNICIAN		03299
1387	PMAC Base Volt	Setup::Motor Control::Motor Data PMAC Parameters::Motor Control::PMAC Motor Data	REAL	400.00	0.00 to 1000.00	V	ALWAYS	TECHNICIAN	6,4	03301
1388	ATN PMAC Test Disable	Setup::Motor Control::Autotune Parameters::Motor Control::Autotune	WORD (bitfield)	0000	0:Stator Resistance 1:Leakage Inductance 2:KE Constant		STOPPED	TECHNICIAN	6,4	03303
1389	ATN PMAC Test Disable.Stator Resistance	Same as PNO 1388	BOOL	FALSE			STOPPED	TECHNICIAN	6,4	03305
1390	ATN PMAC Test Disable.Leakage Inductance	Same as PNO 1388	BOOL	FALSE			STOPPED	TECHNICIAN	6,4	03307
1391	ATN PMAC Test Disable.KE Constant	Same as PNO 1388	BOOL	FALSE			STOPPED	TECHNICIAN	6,4	03309
1405	ATN PMAC Ls Test Freq	Same as PNO 1388	REAL	100.0	0.0 to 500.0	Hz	STOPPED	ENGINEER	6,4	03337
1406	HV Power On Count	Parameters::Device Manager::Runtime Statistics	UINT		0 to 65535		NEVER	TECHNICIAN	1	03339
1407	Motor Run Time	Parameters::Device Manager::Runtime Statistics	UDINT		0 to Max	s	NEVER	TECHNICIAN	1	03341
1408	Warranty Trips Record	Parameters::Trips::Trips History	DWORD (bitfield)		0:01 OVER VOLTAGE 2:03 OVER CURRENT 3:04 STACK FAULT		NEVER	ENGINEER	1	03343

Parameter Reference C-253

PNO	Name	Path	Type	Default	Range	Units	WQ	View	Notes	MBus
					4:05 STACK OVER CURRENT 7:08 INVERSE TIME 10:11 HEATSINK OVERTEMP 11:12 INTERNAL OVERTEMP 14:15 BRAKE SHORT CCT 16:17 BRAKE SWITCH 21:22 VDC RIPPLE					
1409	Warranty Trips Record.01 OVER VOLTAGE	Parameters::Trips::Trips History	BOOL				NEVER	ENGINEER	1	03345
1411	Warranty Trips Record.03 OVER CURRENT	Parameters::Trips::Trips History	BOOL				NEVER	ENGINEER	1	03349
1412	Warranty Trips Record.04 STACK FAULT	Parameters::Trips::Trips History	BOOL				NEVER	ENGINEER	1	03351
1413	Warranty Trips Record.05 STACK OVER CURRENT	Parameters::Trips::Trips History	BOOL				NEVER	ENGINEER	1	03353
1416	Warranty Trips Record.08 INVERSE TIME	Parameters::Trips::Trips History	BOOL				NEVER	ENGINEER	1	03359
1419	Warranty Trips Record.11 HEATSINK OVERTEMP	Parameters::Trips::Trips History	BOOL				NEVER	ENGINEER	1	03365
1420	Warranty Trips Record.12 INTERNAL OVERTEMP	Parameters::Trips::Trips History	BOOL				NEVER	ENGINEER	1	03367
1423	Warranty Trips Record.15 BRAKE SHORT CCT	Parameters::Trips::Trips History	BOOL				NEVER	ENGINEER	1	03373
1425	Warranty Trips Record.17 BRAKE SWITCH	Parameters::Trips::Trips History	BOOL				NEVER	ENGINEER	1	03377
1430	Warranty Trips Record.22 VDC RIPPLE	Parameters::Trips::Trips History	BOOL				NEVER	ENGINEER	1	03387
1441	Anout 01 ABS	Setup::Inputs and Outputs::Base IO Parameters::Inputs And Outputs::IO Configure	BOOL	FALSE			ALWAYS	OPERATOR	4	03409
1442	Recent Trip Times	Parameters::Trips::Trips History	ARRAY[0..9]				NEVER	OPERATOR		03411
1443	Recent Trip Times[0]	Parameters::Trips::Trips History	UDINT		0 to Max	s	NEVER	OPERATOR	1	03413
1444	Recent Trip Times[1]	Parameters::Trips::Trips History	UDINT		0 to Max	s	NEVER	OPERATOR	1	03415
1445	Recent Trip Times[2]	Parameters::Trips::Trips History	UDINT		0 to Max	s	NEVER	OPERATOR	1	03417
1446	Recent Trip Times[3]	Parameters::Trips::Trips History	UDINT		0 to Max	s	NEVER	OPERATOR	1	03419
1447	Recent Trip Times[4]	Parameters::Trips::Trips History	UDINT		0 to Max	s	NEVER	OPERATOR	1	03421
1448	Recent Trip Times[5]	Parameters::Trips::Trips History	UDINT		0 to Max	s	NEVER	OPERATOR	1	03423
1449	Recent Trip Times[6]	Parameters::Trips::Trips History	UDINT		0 to Max	s	NEVER	OPERATOR	1	03425
1450	Recent Trip Times[7]	Parameters::Trips::Trips History	UDINT		0 to Max	s	NEVER	OPERATOR	1	03427
1451	Recent Trip Times[8]	Parameters::Trips::Trips History	UDINT		0 to Max	s	NEVER	OPERATOR	1	03429
1452	Recent Trip Times[9]	Parameters::Trips::Trips History	UDINT		0 to Max	s	NEVER	OPERATOR	1	03431
1458	Modbus Conn Timeout	Parameters::Base Comm::Modbus	TIME	66.000	0.000 to 100000.000	s	ALWAYS	TECHNICIAN		03443
1459	Max Spd when Autotuned	Parameters::Motor Control::Autotune	REAL	x.	-1 to 100000	RPM	NEVER	ENGINEER	3,6,9,4	03445
1460	Anout 02 Scale	Same as PNO 1441	REAL	1.0000	Min to Max		ALWAYS	OPERATOR		03447
1461	Anin 11 Offset	Setup::Inputs and Outputs::Option Parameters::Option IO::General Purpose IO	REAL	0.00	Min to Max	%	ALWAYS	OPERATOR	4	03449
1462	Anin 11 Scale	Same as PNO 1461	REAL	1.0000	Min to Max		ALWAYS	OPERATOR	4	03451
1463	Anin 12 Offset	Same as PNO 1461	REAL	0.00	Min to Max	%	ALWAYS	OPERATOR	4	03453
1464	Anin 12 Scale	Same as PNO 1461	REAL	1.0000	Min to Max		ALWAYS	OPERATOR	4	03455
1465	Anin 13 Offset	Same as PNO 1461	REAL	0.00	Min to Max	%	ALWAYS	OPERATOR	4	03457
1466	Anin 13 Scale	Same as PNO 1461	REAL	1.0000	Min to Max		ALWAYS	OPERATOR	4	03459
1467	Anout 02 Offset	Same as PNO 1441	REAL	0.00	Min to Max	%	ALWAYS	OPERATOR		03461
1468	Anout 02 ABS	Same as PNO 1441	BOOL	FALSE			ALWAYS	OPERATOR		03463
1469	AR Enable	Setup::Motor Control::Auto Restart Parameters::Motor Control::Auto Restart	BOOL	FALSE			ALWAYS	OPERATOR		03465
1470	AR Mode	Same as PNO 1469	USINT (enum)	1	0:TRIP RESET 1:AUTO RESTART 2:AUTO START		ALWAYS	OPERATOR		03467
1471	AR Max Restarts	Same as PNO 1469	USINT	10	1 to 20		ALWAYS	OPERATOR		03469
1472	AR Trip Mask	Same as PNO 1469	DWORD (bitfield)	FFFFFFFF	Same as PNO 763		ALWAYS	TECHNICIAN		03471
1473	AR Trip Mask.01 OVER VOLTAGE	Same as PNO 1469	BOOL	TRUE			ALWAYS	TECHNICIAN		03473
1474	AR Trip Mask.02 UNDER VOLTAGE	Same as PNO 1469	BOOL	TRUE			ALWAYS	TECHNICIAN		03475
1475	AR Trip Mask.03 OVER CURRENT	Same as PNO 1469	BOOL	TRUE			ALWAYS	TECHNICIAN		03477
1476	AR Trip Mask.04 STACK FAULT	Same as PNO 1469	BOOL	TRUE			ALWAYS	TECHNICIAN		03479
1477	AR Trip Mask.05 STACK OVER CURRENT	Same as PNO 1469	BOOL	TRUE			ALWAYS	TECHNICIAN		03481
1478	AR Trip Mask.06 CURRENT LIMIT	Same as PNO 1469	BOOL	TRUE			ALWAYS	TECHNICIAN		03483
1479	AR Trip Mask.07 MOTOR STALL	Same as PNO 1469	BOOL	TRUE			ALWAYS	TECHNICIAN		03485
1480	AR Trip Mask.08 INVERSE TIME	Same as PNO 1469	BOOL	TRUE			ALWAYS	TECHNICIAN		03487
1481	AR Trip Mask.09 MOTOR I2T	Same as PNO 1469	BOOL	TRUE			ALWAYS	TECHNICIAN		03489
1482	AR Trip Mask.10 LOW SPEED I	Same as PNO 1469	BOOL	TRUE			ALWAYS	TECHNICIAN		03491
1483	AR Trip Mask.11 HEATSINK OVERTEMP	Same as PNO 1469	BOOL	TRUE			ALWAYS	TECHNICIAN		03493
1484	AR Trip Mask.12 INTERNAL OVERTEMP	Same as PNO 1469	BOOL	TRUE			ALWAYS	TECHNICIAN		03495
1485	AR Trip Mask.13 MOTOR OVERTEMP	Same as PNO 1469	BOOL	TRUE			ALWAYS	TECHNICIAN		03497

C-254 Parameter Reference

PNO	Name	Path	Type	Default	Range	Units	WQ	View	Notes	Mbus
1486	AR Trip Mask.14 EXTERNAL TRIP	Same as PNO 1469	BOOL	TRUE			ALWAYS	TECHNICIAN		03499
1487	AR Trip Mask.15 BRAKE SHORT CCT	Same as PNO 1469	BOOL	TRUE			ALWAYS	TECHNICIAN		03501
1488	AR Trip Mask.16 BRAKE RESISTOR	Same as PNO 1469	BOOL	TRUE			ALWAYS	TECHNICIAN		03503
1489	AR Trip Mask.17 BRAKE SWITCH	Same as PNO 1469	BOOL	TRUE			ALWAYS	TECHNICIAN		03505
1490	AR Trip Mask.18 LOCAL CONTROL	Same as PNO 1469	BOOL	TRUE			ALWAYS	TECHNICIAN		03507
1491	AR Trip Mask.19 COMMS BREAK	Same as PNO 1469	BOOL	TRUE			ALWAYS	TECHNICIAN		03509
1492	AR Trip Mask.20 LINE CONTACTOR	Same as PNO 1469	BOOL	TRUE			ALWAYS	TECHNICIAN		03511
1493	AR Trip Mask.21 PHASE FAIL	Same as PNO 1469	BOOL	TRUE			ALWAYS	TECHNICIAN		03513
1494	AR Trip Mask.22 VDC RIPPLE	Same as PNO 1469	BOOL	TRUE			ALWAYS	TECHNICIAN		03515
1495	AR Trip Mask.23 BASE MODBUS BREAK	Same as PNO 1469	BOOL	TRUE			ALWAYS	TECHNICIAN		03517
1496	AR Trip Mask.24 24 V OVERLOAD	Same as PNO 1469	BOOL	TRUE			ALWAYS	TECHNICIAN		03519
1497	AR Trip Mask.25 PMAC SPEED ERROR	Same as PNO 1469	BOOL	TRUE			ALWAYS	TECHNICIAN		03521
1498	AR Trip Mask.26 OVERSPEED	Same as PNO 1469	BOOL	TRUE			ALWAYS	TECHNICIAN		03523
1499	AR Trip Mask.27 STO ACTIVE	Same as PNO 1469	BOOL	TRUE			ALWAYS	TECHNICIAN		03525
1500	AR Trip Mask.28 FEEDBACK MISSING	Same as PNO 1469	BOOL	TRUE			ALWAYS	TECHNICIAN		03527
1501	AR Trip Mask.29 INTERNAL FAN FAIL	Same as PNO 1469	BOOL	TRUE			ALWAYS	TECHNICIAN		03529
1502	AR Trip Mask.30 CURRENT SENSOR	Setup::Motor Control::Auto Restart Parameters::Motor Control::Auto Restart	BOOL	TRUE			ALWAYS	TECHNICIAN		03531
1503	AR Trip Mask.31 POWER LOSS STOP	Same as PNO 1502	BOOL	TRUE			ALWAYS	TECHNICIAN		03533
1504	AR Trip Mask.32 SPEED SENSOR	Same as PNO 1502	BOOL	TRUE			ALWAYS	TECHNICIAN		03535
1505	AR Initial Delay	Same as PNO 1502	TIME	10.000	0.000 to 3600.000	s	ALWAYS	OPERATOR		03537
1506	AR Repeat Delay	Same as PNO 1502	TIME	60.000	0.000 to 3600.000	s	ALWAYS	OPERATOR		03539
1507	AR Active	Parameters::Motor Control::Auto Restart	BOOL				NEVER	OPERATOR		03541
1508	AR Restart Pending	Parameters::Motor Control::Auto Restart	BOOL				NEVER	OPERATOR		03543
1509	AR Restarts Remaining	Parameters::Motor Control::Auto Restart	USINT		0 to 20		NEVER	OPERATOR		03545
1510	AR Time Remaining	Parameters::Motor Control::Auto Restart	TIME		0.000 to 3600.000	s	NEVER	OPERATOR		03547
1511	Encoder Supply	Setup::Inputs and Outputs::Option Parameters::Option IO::Encoder	USINT (enum)	0	0:5 V 1:12 V 2:15 V 3:24 V		STOPPED	TECHNICIAN	4	03549
1512	Encoder Lines	Same as PNO 1511	DINT	2048	1 to 100000		STOPPED	TECHNICIAN	4	03551
1513	Encoder Invert	Same as PNO 1511	BOOL	FALSE			STOPPED	TECHNICIAN	9,4	03553
1514	Encoder Type	Same as PNO 1511	USINT (enum)	0	0:QUADRATURE 1:CLOCK/DIRECTION		STOPPED	TECHNICIAN	4	03555
1515	Encoder Single Ended	Same as PNO 1511	BOOL	FALSE			STOPPED	TECHNICIAN	4	03557
1516	Encoder Speed	Monitor::Inputs and Outputs Parameters::Option IO::Encoder	REAL	x.	Min to Max	RPM	NEVER	OPERATOR	4	03559
1517	Encoder Count Reset	Same as PNO 1511	BOOL	FALSE			ALWAYS	TECHNICIAN	2,4	03561
1518	Encoder Count	Same as PNO 1516	DINT		Min to Max		NEVER	TECHNICIAN	1,4	03563
1520	Actual Rotor T Const	Parameters::Motor Control::Tr Adaptation	REAL	x.	1 to 100000	ms	NEVER	ENGINEER	4	03567
1521	Tr Adaptation Output	Parameters::Motor Control::Tr Adaptation	REAL	x.	1 to 500	%	NEVER	ENGINEER	4	03569
1526	Energy Saving Lower Lim	Parameters::Motor Control::Fluxing VHz	REAL	0.00	0.00 to 1.00		ALWAYS	OPERATOR	4	03579
1527	Max Available Volts	Parameters::Motor Control::Tr Adaptation	REAL	x.	0 to 10000	V	NEVER	ENGINEER	4	03581
1528	Demanded Terminal Volts	Parameters::Motor Control::Tr Adaptation	REAL	x.	0 to 1000	V	NEVER	ENGINEER	4	03583
1529	Terminal Volts	Parameters::Motor Control::Tr Adaptation	REAL	x.	0 to 1000	V	NEVER	ENGINEER	4	03585
1533	Control Type	Setup::Motor Control::Control and Type Parameters::Control Mode::Control Mode	USINT (enum)	0	0:SENSORLESS 1:ENCODER FEEDBACK		STOPPED	TECHNICIAN	6,4	03593
1534	Clone Filename	Setup::Clone Parameters::Device Manager::Clone	STRING[24]	clone			ALWAYS	TECHNICIAN	2	03595
1537	Clone Direction	Same as PNO 1534	USINT (enum)	0	0:SAVE TO FILE 1:LOAD FROM FILE		ALWAYS	TECHNICIAN	2,4	03601
1538	Full Restore	Same as PNO 1534	USINT (enum)	0	0:YES 1:PARTIAL		ALWAYS	TECHNICIAN	2,4	03603
1539	Application	Same as PNO 1534	USINT (enum)	0	0:LOAD FROM FILE 1:LEAVE CURRENT APP		ALWAYS	TECHNICIAN	2,4	03605
1540	Other Parameters	Same as PNO 1534	USINT (enum)	0	0:LOAD FROM FILE 1:LEAVE CURRENT VALUES 2:SET TO DEFAULT VALUES		ALWAYS	TECHNICIAN	2,4	03607
1541	Power Parameters	Same as PNO 1534	USINT (enum)	0	Same as PNO 1540		ALWAYS	TECHNICIAN	2,4	03609
1542	Clone Start	Same as PNO 1534	BOOL	FALSE			ALWAYS	TECHNICIAN	2,4	03611
1543	Clone Status	Same as PNO 1534	USINT (enum)		0:IDLE 1:SAVING 2:RESTORING 3:VERIFYING 4:DONE 5:CANNOT START		NEVER	TECHNICIAN		03613

Parameter Reference C-255

PNO	Name	Path	Type	Default	Range	Units	WQ	View	Notes	Mbus
					6:FAILED 7:NO SD CARD 8:VERIFY FAILED 9:FILE NOT OPENED 10:FILE INCOMPATIBLE 11:FILE FAILURE 12:POWER MISMATCH 13:APPLICATION FAILURE 14:PARAMETERS FAILURE 15:PNET SECTION MISSING 16:CARD FAULT					
1544	Filter Type	Parameters::Motor Control::Filter On Torque Dmd	USINT (enum)	0	0:NONE 1:MAX ATTENUATION 2:MINIMUM PHASE 3:PHASE ADVANCE 4:NOTCH		ALWAYS	TECHNICIAN	4	03615
1545	Cut Off Frequency	Parameters::Motor Control::Filter On Torque Dmd	REAL	2000	20 to 6000	Hz	ALWAYS	TECHNICIAN	4	03617
1546	Frequency 1	Parameters::Motor Control::Filter On Torque Dmd	REAL	2000	20 to 6000	Hz	ALWAYS	TECHNICIAN	4	03619
1547	Frequency 2	Parameters::Motor Control::Filter On Torque Dmd	REAL	2000	20 to 6000	Hz	ALWAYS	TECHNICIAN	4	03621
1548	Factor	Parameters::Motor Control::Filter On Torque Dmd	REAL	0.20	0.10 to 1.00		ALWAYS	TECHNICIAN	4	03623
1549	Application Volts	Parameters::Motor Control::Fluxing VHz	REAL	0.00	0.00 to 150.00	%	ALWAYS	OPERATOR	4	03625
1550	Nameplate Mag Current	Setup::Motor Control::Autotune Parameters::Motor Control::Autotune	REAL	0.88	0.01 to 1000.00	A	STOPPED	TECHNICIAN	6,4	03627
1551	Product Code Flags	Parameters::Device Manager::Drive info	BYTE				NEVER	ENGINEER		03629
1554	Application Name	Parameters::Application::App Info	STRING[20]				NEVER	TECHNICIAN		03635
1560	Start Delay Enable	Parameters::Motor Control::Motor Sequencer	BOOL	FALSE			STOPPED	TECHNICIAN		03647
1565	Local Power Up Mode	Parameters::Motor Control::Sequencing	USINT (enum)	0	0:AS WHEN POWERED DOWN 1:LOCAL 2:REMOTE		ALWAYS	TECHNICIAN		03657
1567	Modbus Mapping	Setup::Communications::Base Modbus Parameters::Base Comms::Modbus	ARRAY[0..15]				ALWAYS	ENGINEER		03661
1568	Modbus Mapping[0]	Same as PNO 1567	UINT	0000	0000 to 3145		ALWAYS	ENGINEER		03663
1569	Modbus Mapping[1]	Same as PNO 1567	UINT	0000	0000 to 3145		ALWAYS	ENGINEER		03665
1570	Modbus Mapping[2]	Same as PNO 1567	UINT	0000	0000 to 3145		ALWAYS	ENGINEER		03667
1571	Modbus Mapping[3]	Same as PNO 1567	UINT	0000	0000 to 3145		ALWAYS	ENGINEER		03669
1572	Modbus Mapping[4]	Same as PNO 1567	UINT	0000	0000 to 3145		ALWAYS	ENGINEER		03671
1573	Modbus Mapping[5]	Same as PNO 1567	UINT	0000	0000 to 3145		ALWAYS	ENGINEER		03673
1574	Modbus Mapping[6]	Same as PNO 1567	UINT	0000	0000 to 3145		ALWAYS	ENGINEER		03675
1575	Modbus Mapping[7]	Same as PNO 1567	UINT	0000	0000 to 3145		ALWAYS	ENGINEER		03677
1576	Modbus Mapping[8]	Same as PNO 1567	UINT	0000	0000 to 3145		ALWAYS	ENGINEER		03679
1577	Modbus Mapping[9]	Same as PNO 1567	UINT	0000	0000 to 3145		ALWAYS	ENGINEER		03681
1578	Modbus Mapping[10]	Same as PNO 1567	UINT	0000	0000 to 3145		ALWAYS	ENGINEER		03683
1579	Modbus Mapping[11]	Same as PNO 1567	UINT	0000	0000 to 3145		ALWAYS	ENGINEER		03685
1580	Modbus Mapping[12]	Same as PNO 1567	UINT	0000	0000 to 3145		ALWAYS	ENGINEER		03687
1581	Modbus Mapping[13]	Same as PNO 1567	UINT	0000	0000 to 3145		ALWAYS	ENGINEER		03689
1582	Modbus Mapping[14]	Same as PNO 1567	UINT	0000	0000 to 3145		ALWAYS	ENGINEER		03691
1583	Modbus Mapping[15]	Same as PNO 1567	UINT	0000	0000 to 3145		ALWAYS	ENGINEER		03693
1632	Mapping Valid	Monitor::Communications::Base Modbus Parameters::Base Comms::Modbus	BOOL				NEVER	OPERATOR		03791
1633	Application User Boost	Parameters::Motor Control::Fluxing VHz	REAL	0.00	0.00 to 25.00	%	ALWAYS	OPERATOR	4	03793
1634	Start Delay	Parameters::Motor Control::Motor Sequencer	TIME	0.000	0.000 to 30.000	s	STOPPED	TECHNICIAN		03795
1635	Delay To Start	Parameters::Motor Control::Motor Sequencer	TIME		0.000 to Max	s	NEVER	TECHNICIAN		03797
1636	Manufacturing Flags	Parameters::Device Manager::Drive info	WORD				NEVER	ENGINEER		03799
1637	Engineer Password	Parameters::Keypad::Graphical Keypad	WORD	0000			ALWAYS	TECHNICIAN		03801
1640	Modbus Password	Setup::Communications::Option Parameters::Option Comms::Modbus RTU	WORD	0000			ALWAYS	TECHNICIAN	4	03807
1641	VDC Lim Enable	Parameters::Motor Control::DC Link Volts Limit	BOOL	FALSE			STOPPED	TECHNICIAN		03809
1642	VDC Lim Level	Parameters::Motor Control::DC Link Volts Limit	REAL	91.0	78.0 to 100.0	%	STOPPED	TECHNICIAN		03811
1643	VDC Lim Active	Parameters::Motor Control::DC Link Volts Limit	BOOL				NEVER	TECHNICIAN		03813
1644	VDC Lim Output	Parameters::Motor Control::DC Link Volts Limit	REAL	x.x	Min to Max	Hz	NEVER	ENGINEER		03815
1645	Pwrl Enable	Parameters::Motor Control::Power Loss Ride Thru	BOOL	FALSE			STOPPED	TECHNICIAN		03817

C-256 Parameter Reference

PNO	Name	Path	Type	Default	Range	Units	WQ	View	Notes	Mbus
1646	Pwrl Trip Threshold	Parameters::Motor Control::Power Loss Ride Thru	REAL	52.0	20.0 to 60.0	%	STOPPED	TECHNICIAN		03819
1647	Pwrl Control Band	Parameters::Motor Control::Power Loss Ride Thru	REAL	2.0	0.0 to 20.0	%	STOPPED	TECHNICIAN		03821
1648	Pwrl Accel Rate	Parameters::Motor Control::Power Loss Ride Thru	REAL	100	1 to 500	Hz/s	STOPPED	TECHNICIAN		03823
1649	Pwrl Decel Rate	Parameters::Motor Control::Power Loss Ride Thru	REAL	100	1 to 500	Hz/s	STOPPED	TECHNICIAN		03825
1650	Pwrl Time Limit	Parameters::Motor Control::Power Loss Ride Thru	TIME	30.000	0.000 to 300.000	s	STOPPED	TECHNICIAN		03827
1651	Pwrl Active	Parameters::Motor Control::Power Loss Ride Thru	BOOL				NEVER	TECHNICIAN		03829
1658	Current Diff Level	Parameters::Trips::Current Sensor Trip	REAL	25.00	0.00 to 100.00	%	ALWAYS	OPERATOR	4	03843
1659	Modbus TCP Password	Setup::Communications::Base Modbus Parameters::Base Comms::Modbus	WORD	0000			ALWAYS	TECHNICIAN		03845
1661	PTP Enable	Setup::Communications::PTP Parameters::Base Comms::PTP	BOOL	FALSE			ALWAYS	TECHNICIAN		03849
1663	Encoder Supply	Setup::Inputs and Outputs::SB Encoder Slot1 Parameters::System Board::SB Encoder Slot 1	USINT (enum)	0	0:5 V 1:12 V 2:15 V 3:20 V		STOPPED	TECHNICIAN	4	03853
1664	Encoder Lines	Same as PNO 1663	DINT	2048	1 to 100000		STOPPED	TECHNICIAN	4	03855
1665	Encoder Invert	Same as PNO 1663	BOOL	FALSE			STOPPED	TECHNICIAN	4	03857
1666	Encoder Type	Same as PNO 1663	USINT (enum)	0	Same as PNO 1514		STOPPED	TECHNICIAN	4	03859
1667	High Input Threshold	Same as PNO 1663	BOOL	FALSE			STOPPED	TECHNICIAN	4	03861
1668	Encoder Speed	Monitor::System Board::SB Encoder Slot 1 Parameters::System Board::SB Encoder Slot 1	REAL	x.	Min to Max	RPM	NEVER	TECHNICIAN	4	03863
1669	Encoder Count Reset	Same as PNO 1663	BOOL	FALSE			ALWAYS	TECHNICIAN	2,4	03865
1670	Encoder Count	Same as PNO 1668	DINT		Min to Max		NEVER	TECHNICIAN	1,4	03867
1671	Encoder Lines	Setup::Inputs and Outputs::SB Encoder Slot2 Parameters::System Board::SB Encoder Slot 2	DINT	2048	1 to 100000		STOPPED	TECHNICIAN	4	03869
1672	Encoder Invert	Same as PNO 1671	BOOL	FALSE			STOPPED	TECHNICIAN	4	03871
1673	Encoder Type	Same as PNO 1671	USINT (enum)	0	Same as PNO 1514		STOPPED	TECHNICIAN	4	03873
1674	High Input Threshold	Same as PNO 1671	BOOL	FALSE			STOPPED	TECHNICIAN	4	03875
1675	Encoder Speed	Monitor::System Board::SB Encoder Slot 2 Parameters::System Board::SB Encoder Slot 2	REAL	x.	Min to Max	RPM	NEVER	OPERATOR	4	03877
1676	Encoder Count Reset	Same as PNO 1671	BOOL	FALSE			ALWAYS	TECHNICIAN	2,4	03879
1677	Encoder Count	Same as PNO 1675	DINT		Min to Max		NEVER	TECHNICIAN	1,4	03881
1678	Output Enable	Setup::Inputs and Outputs::System Board Option Parameters::System Board::SB Retransmit	BOOL	FALSE			ALWAYS	ENGINEER	4	03883
1679	Output Source	Same as PNO 1678	USINT (enum)	0	0:SYSTEM BOARD SLOT 1 1:SYSTEM BOARD SLOT 2 2:SYNTHETIC ENCDR 3:DIGITAL OUTPUTS 4:MAIN SPD FEEDBACK		STOPPED	ENGINEER	4	03885
1680	Output Voltage	Same as PNO 1678	USINT (enum)	0	Same as PNO 1663		ALWAYS	ENGINEER	4	03887
1681	PTP Log Sync Interval	Same as PNO 1661	SINT	-1	-1 to 0		ALWAYS	ENGINEER		03889
1682	Random Pattern AFE	Parameters::Motor Control::Pattern Generator	BOOL	FALSE			ALWAYS	ENGINEER	4	03891
1683	PTP Clock Mode	Same as PNO 1661	USINT (enum)	0	0:E2E		ALWAYS	ENGINEER		03893
1684	PTP Clock Type	Same as PNO 1661	USINT (enum)	0	0:MASTER OR SLAVE 1:SLAVE ONLY		ALWAYS	ENGINEER		03895
1685	PTP Lock Threshold	Same as PNO 1661	REAL	0.5	0.1 to 100.0	us	ALWAYS	ENGINEER		03897
1686	PTP Priority2	Same as PNO 1661	USINT	128	0 to 255		ALWAYS	ENGINEER		03899
1687	PTP Offset	Monitor::Communications::PTP Parameters::Base Comms::PTP	DINT		Min to Max	ns	NEVER	OPERATOR		03901
1688	PTP Locked	Same as PNO 1687	BOOL				NEVER	OPERATOR		03903
1689	PTP State	Same as PNO 1687	USINT (enum)		0:NONE 1:INITIALISNG 2:FAULTY 3:DISABLED 4:LISTENING 5:PRE_MASTER 6:MASTER		NEVER	OPERATOR		03905

Parameter Reference C-257

PNO	Name	Path	Type	Default	Range	Units	WQ	View	Notes	MBus
					7:PASSIVE 8:UNCALIBRATED 9:SLAVE					
1690	AFE Close Ext PCR	Parameters::Regen Control::AFE	BOOL	FALSE			ALWAYS	OPERATOR	4	03907
1691	AFE Ext PCR Closed	Parameters::Regen Control::AFE	BOOL	FALSE			ALWAYS	OPERATOR	4	03909
1692	AFE PF Angle Demand	Parameters::Regen Control::AFE	REAL	0.00	-90.00 to 90.00	deg	ALWAYS	OPERATOR	4	03911
1693	AFE Current Control	Setup::Regen Control Parameters::Regen Control::AFE	BOOL	FALSE			ALWAYS	OPERATOR	4	03913
1694	AFE PLL Kp	Parameters::Regen Control::AFE	REAL	5.48	0.00 to 30.00		ALWAYS	OPERATOR	4	03915
1695	AFE PLL Ti	Parameters::Regen Control::AFE	REAL	0.0318	0.0000 to 3.0000		ALWAYS	OPERATOR	4	03917
1696	Synth Encoder Lines	Same as PNO 1678	DINT	2048	1 to 15000000		ALWAYS	TECHNICIAN	4	03919
1697	AFE VDC Min Level	Parameters::Regen Control::AFE	REAL	400.00	340.00 to 5000.00		ALWAYS	OPERATOR	4	03921
1698	Synth Encoder Speed	Same as PNO 1678	REAL	0	0 to 15000000	RPM	ALWAYS	TECHNICIAN	4	03923
1699	PTP Clock	Same as PNO 1687	DT		1970/01/01 to 2038/01/19		NEVER	OPERATOR		03925
1701	Switchover Enable	Parameters::Motor Control::MRAS	BOOL	FALSE			ALWAYS	ENGINEER	4	03929
1702	Synth Encoder Invert	Same as PNO 1678	BOOL	FALSE			ALWAYS	TECHNICIAN	4	03931
1703	AFE Sync Frequency	Monitor::Regen Control Parameters::Regen Control::AFE	REAL	x.xx	Min to Max	Hz	NEVER	OPERATOR	3,4	03933
1704	AFE Id Demand	Same as PNO 1693	REAL	0.10	-1.50 to 1.50		ALWAYS	OPERATOR	4	03935
1705	AFE Iq Demand	Same as PNO 1693	REAL	0.00	-1.50 to 1.50		ALWAYS	OPERATOR	4	03937
1706	AFE Max Current	Parameters::Regen Control::AFE	REAL	1.50	0.00 to 1.50		ALWAYS	OPERATOR	4	03939
1707	AFE VDC Kp	Parameters::Regen Control::AFE	REAL	8.27	0.00 to 300.00		ALWAYS	OPERATOR	4	03941
1708	AFE VDC Ti	Parameters::Regen Control::AFE	REAL	0.0319	0.0000 to 3.0000		ALWAYS	OPERATOR	4	03943
1709	AFE VDC Ramp	Parameters::Regen Control::AFE	REAL	0.05	0.01 to 100.00	%	ALWAYS	OPERATOR	4	03945
1710	AFE VDC Feed Forward	Parameters::Regen Control::AFE	REAL	0.0000	-1.5000 to 1.5000		ALWAYS	OPERATOR	4	03947
1711	AFE VDC Demand	Same as PNO 1693	REAL	720	340 to 820	V	ALWAYS	OPERATOR	4	03949
1712	AFE Synchronizing	Parameters::Regen Control::AFE	BOOL				NEVER	OPERATOR	3,4	03951
1713	AFE Synchronized	Parameters::Regen Control::AFE	BOOL				NEVER	OPERATOR	3,4	03953
1714	AFE Enable Drive	Parameters::Regen Control::AFE	BOOL				NEVER	OPERATOR	3,4	03955
1715	AFE Phase Loss	Parameters::Regen Control::AFE	BOOL				NEVER	OPERATOR	3,4	03957
1716	AFE Brake Mode	Parameters::Regen Control::AFE	BOOL	FALSE			ALWAYS	OPERATOR	4	03959
1717	AFE Correction Angle	Parameters::Regen Control::AFE	REAL	0.00	-90.00 to 90.00		ALWAYS	OPERATOR	4	03961
1718	AFE Sync Angle	Parameters::Regen Control::AFE	REAL	x.xx	Min to Max	deg	NEVER	OPERATOR	3,4	03963
1721	AFE Status	Same as PNO 1703	USINT (enum)		0:INACTIVE 1:SYNCHRONIZING 2:SYNCHRONIZED 3:SUPPLY FREQ HIGH 4:SUPPLY FREQ LOW 5:SYNC FAILED		NEVER	OPERATOR	3,4	03969
1722	SB Digital Input 2	Monitor::Inputs and Outputs Parameters::System Board::SB Digital IO	BOOL				NEVER	OPERATOR	4	03971
1723	SB Digital Input 3	Same as PNO 1722	BOOL				NEVER	OPERATOR	4	03973
1725	Peer to Peer Enable	Setup::Communications::Peer to Peer Parameters::Base Comms::Peer to Peer	BOOL	FALSE			ALWAYS	TECHNICIAN		03977
1726	Destination IP Address	Same as PNO 1725	DWORD (IP_addr)	255.255.255.255			ALWAYS	ENGINEER		03979
1727	Destination Port	Same as PNO 1725	UINT	1250	0 to 65535		ALWAYS	ENGINEER		03981
1728	Local Port	Same as PNO 1725	UINT	1250	1 to 65535		ALWAYS	ENGINEER		03983
1729	Peer to Peer State	Monitor::Communications::Peer to Peer Parameters::Base Comms::Peer to Peer	USINT (enum)		0:DISABLED 1:ACTIVE 2:ERROR		NEVER	OPERATOR		03985
1730	AFE Inductance	Setup::Regen Control Parameters::Regen Control::AFE	REAL	0.00	0.00 to 1000.00	mH	ALWAYS	OPERATOR	4	03987
1731	AFE Transf Angle Offset	Parameters::Regen Control::AFE	REAL	0.00	0.00 to 360.00	deg	ALWAYS	OPERATOR	4	03989
1732	Motor Start Count	Parameters::Device Manager::Runtime Statistics	UDINT		0 to Max		NEVER	TECHNICIAN	1	03991
1733	Time Since Power-On	Parameters::Device Manager::Runtime Statistics	TIME		0.000 to Max	s	NEVER	TECHNICIAN		03993
1734	AR Trip Mask B	Parameters::Motor Control::Auto Restart	DWORD	00000000			ALWAYS	TECHNICIAN		03995
1735	AR Trip Mask 2 B	Parameters::Motor Control::Auto Restart	DWORD	00000000			ALWAYS	TECHNICIAN		03997
1736	AR Initial Delay B	Parameters::Motor Control::Auto Restart	TIME	60.000	0.000 to 3600.000	s	ALWAYS	OPERATOR		03999
1737	AR Repeat Delay B	Parameters::Motor Control::Auto Restart	TIME	120.000	0.000 to 3600.000	s	ALWAYS	OPERATOR		04001
1738	Enable Auto Save	Parameters::Device Manager::Setup Wizard	BOOL	TRUE			ALWAYS	ENGINEER		04003
1739	System Board Required	Setup::Inputs and Outputs::System Board Option Parameters::System Board::System Board Option	USINT (enum)	0	0:NONE 1:DUAL ENCODER 2:ABSOLUTE		CONFIG	TECHNICIAN		04005

C-258 Parameter Reference

PNO	Name	Path	Type	Default	Range	Units	WQ	View	Notes	Mbus
1740	System Board Fitted	Parameters::System Board::System Board Option	USINT (enum)		Same as PNO 1739		NEVER	OPERATOR	1	04007
1741	System Board Status	Parameters::System Board::System Board Option	USINT (enum)		Same as PNO 1180		NEVER	OPERATOR		04009
1742	System Board FE State	Parameters::Device Manager::Device State	USINT (enum)		Same as PNO 989		NEVER	OPERATOR		04011
1743	Encoder Feedback	Setup::Motor Control::Control and Type Parameters::Control Mode::Control Mode	USINT (enum)	0	0:MAIN SPD FEEDBACK 1:SYSTEM BOARD SLOT 1 2:SYSTEM BOARD SLOT 2 3:NONE		STOPPED	TECHNICIAN	6,4	04013
1744	Slave Position Src	Parameters::Phase Control::Configure	USINT (enum)	0	0:SAME AS MOTOR FBK 1:MAIN SPD FEEDBACK 2:SYSTEM BOARD SLOT 1 3:SYSTEM BOARD SLOT 2 4:OTHER		STOPPED	TECHNICIAN	6	04015
1745	Master Position Src	Parameters::Phase Control::Configure	USINT (enum)	3	0:MAIN SPD FEEDBACK 1:SYSTEM BOARD SLOT 1 2:SYSTEM BOARD SLOT 2 3:NONE 4:OTHER		STOPPED	TECHNICIAN	6	04017
1746	Speed Error Trip Enable	Parameters::Trips::Speed Error Trip	BOOL	TRUE			ALWAYS	TECHNICIAN	4	04019
1747	Speed Error Threshold	Parameters::Trips::Speed Error Trip	REAL	50.00	0.00 to 100.00	%	ALWAYS	TECHNICIAN	4	04021
1748	Speed Error Trip Delay	Parameters::Trips::Speed Error Trip	TIME	10.000	0.000 to 2000.000	s	ALWAYS	TECHNICIAN	4	04023
1749	Setup Successful	Parameters::Phase Control::Configure	BOOL				NEVER	TECHNICIAN		04025
1750	Error Number	Parameters::Phase Control::Configure	INT		-32768 to 32767		NEVER	TECHNICIAN		04027
1751	Master Encoder	Parameters::Phase Control::Configure	USINT (enum)		0:EMPTY FUNC 1:ESTIMATOR 2:PRIMARY 3:SYSTEM BOARD SLOT 1 4:SYSTEM BOARD SLOT 2 5:OTHER		NEVER	TECHNICIAN		04029
1752	Slave Encoder	Parameters::Phase Control::Configure	USINT (enum)		Same as PNO 1751		NEVER	TECHNICIAN		04031
1753	Spd Loop Encoder	Parameters::Phase Control::Configure	USINT (enum)		Same as PNO 1751		NEVER	TECHNICIAN		04033
1754	Free Space (kBytes)	Parameters::Device Manager::Flash File System	UDINT		0 to Max		NEVER	ENGINEER		04035
1756	Output A	Setup::Inputs and Outputs::System Board Option Parameters::System Board::SB Retransmit	BOOL	FALSE			ALWAYS	OPERATOR	4	04039
1757	Output B	Same as PNO 1756	BOOL	FALSE			ALWAYS	OPERATOR	4	04041
1758	Output Z	Same as PNO 1756	BOOL	FALSE			ALWAYS	OPERATOR	4	04043
1759	SB Digital Input 1	Monitor::Inputs and Outputs Parameters::System Board::SB Digital IO	BOOL				NEVER	OPERATOR	4	04045
1760	Display Warnings	Parameters::Trips::Trips Status	BOOL	TRUE			ALWAYS	OPERATOR		04047
1762	Thermistor Warn Delta	Parameters::Option IO::Thermistor	REAL	100	0 to 4500	Ohm	ALWAYS	TECHNICIAN	4	04051
1779	Auto Hide	Parameters::Device Manager::Setup Wizard	BOOL	TRUE			ALWAYS	ENGINEER		04085
1780	Spd Limiter Torq Ctrl	Parameters::Motor Control::Spd Loop Settings	BOOL	FALSE			ALWAYS	TECHNICIAN	4	04087
1781	Speed Limiter Active	Parameters::Motor Control::Spd Loop Diagnostics	BOOL				NEVER	TECHNICIAN	4	04089
1782	Free Sockets	Parameters::Base Comms::Ethernet	UINT		0 to 65535		NEVER	ENGINEER		04091
1783	Encoder Count Init	Parameters::Option IO::Encoder	BOOL	TRUE			ALWAYS	TECHNICIAN	4	04093
1784	Encoder Count Init	Parameters::System Board::SB Encoder Slot 1	BOOL	TRUE			ALWAYS	TECHNICIAN	4	04095
1785	Encoder Count Init	Parameters::System Board::SB Encoder Slot 2	BOOL	TRUE			ALWAYS	TECHNICIAN	4	04097
1787	PTP Domain Number	Setup::Communications::PTP Parameters::Base Comms::PTP	USINT	0	0 to 127		ALWAYS	ENGINEER		04101
1788	SNTP Client Enable	Parameters::Base Comms::SNTP Client	BOOL	FALSE			ALWAYS	TECHNICIAN		04103
1789	SNTP Remote Server	Parameters::Base Comms::SNTP Client	DWORD (IP addr)	000.000.000.000			ALWAYS	TECHNICIAN		04105
1790	Resolver Voltage	Setup::Inputs and Outputs::Option Parameters::Option IO::Resolver	USINT (enum)	4	0:0V 1:4V 2:5V 3:6V 4:7V 5:8V 6:9V 7:10V 8:11V		STOPPED	TECHNICIAN	4	04107

Parameter Reference C-259

PNO	Name	Path	Type	Default	Range	Units	WQ	View	Notes	MBus
1791	Resolver Frequency	Same as PNO 1790	REAL	8.0	9:12V 2.0 to 20.0	kHz	STOPPED	TECHNICIAN	4	04109
1792	Resolver Ratio	Same as PNO 1790	REAL	0.50	0.15 to 3.00		STOPPED	TECHNICIAN	4	04111
1793	Resolver Poles	Same as PNO 1790	INT	2	2 to 100		STOPPED	TECHNICIAN	4	04113
1794	Soft Key 2 Mode	Parameters::Keypad::Graphical Keypad	USINT (enum)	0	0:LOCAL / REMOTE 1:FORWARD / REVERSE 2:CUSTOM		ALWAYS	OPERATOR		04115
1795	Soft Key 2 Value	Parameters::Keypad::Graphical Keypad	BOOL	FALSE			ALWAYS	OPERATOR	2	04117
1796	Alignment On Power On	Setup::Motor Control::Pos Fbk Alignment Parameters::Motor Control::Pos Fbk Alignment	BOOL	FALSE			STOPPED	TECHNICIAN	6,4	04119
1797	Alignment Method	Same as PNO 1796	USINT (enum)	0	0:MANUAL 1:AUTOMATIC 2:DIRECTION TEST		STOPPED	TECHNICIAN	6,4	04121
1798	Alignment Enable	Same as PNO 1796	BOOL	FALSE			STOPPED	TECHNICIAN	2,4	04123
1799	Alignment Level	Same as PNO 1796	REAL	50	0 to 150	%	ALWAYS	TECHNICIAN	6,4	04125
1800	Alignment Ramp Time	Same as PNO 1796	TIME	1.000	0.000 to 30.000	s	ALWAYS	TECHNICIAN	6,4	04127
1801	Alignment On Motor	Same as PNO 1796	USINT (enum)	0	0:PHASE U 1:PHASE V 2:PHASE W		ALWAYS	TECHNICIAN	6,4	04129
1802	Alignment Offset	Parameters::Motor Control::Pos Fbk Alignment	REAL	x.x	-180.0 to 180.0	deg	NEVER	TECHNICIAN	4	04131
1803	Alignment Elec Pos	Parameters::Motor Control::Pos Fbk Alignment	REAL	x.x	-180.0 to 180.0	deg	NEVER	TECHNICIAN	4	04133
1804	Alignment Direction	Parameters::Motor Control::Pos Fbk Alignment	USINT (enum)		0:STANDARD 1:REVERSE		NEVER	TECHNICIAN	4	04135
1805	Alignment State	Parameters::Motor Control::Pos Fbk Alignment	USINT (enum)		0:OFF 1:ON MANUAL 2:ON AUTO 3:ERROR 4:ENDED		NEVER	TECHNICIAN	4	04137
1806	Alignment Ended	Parameters::Motor Control::Pos Fbk Alignment	BOOL				NEVER	TECHNICIAN	4	04139
1807	Alignment Error	Parameters::Motor Control::Pos Fbk Alignment	USINT (enum)		0:NO ERROR 1:SHAFT LOCKED 2:AMPS 3:LOAD 4:POLES 5:MOTOR UNCONNECTED 6:ENCODER 7:INIT NEEDED		NEVER	TECHNICIAN	4	04141
1808	PMAC Encoder Offset	Setup::Motor Control::Motor Data PMAC Parameters::Motor Control::PMAC Motor Data	REAL	0.0	-180.0 to 180.0	deg	ALWAYS	TECHNICIAN	1,6,9,4	04143
1809	PMAC Wiring	Setup::Motor Control::Motor Data PMAC Monitor::Motor and Drive Parameters::Motor Control::PMAC Motor Data	USINT (enum)	0	Same as PNO 1804		ALWAYS	TECHNICIAN	6,9,4	04145
1810	Resolver Invert	Same as PNO 1790	BOOL	FALSE			STOPPED	TECHNICIAN	4	04147
1811	Resolver Turns	Monitor::Inputs and Outputs Parameters::Option IO::Resolver	DINT		Min to Max		NEVER	TECHNICIAN	1,4	04149
1812	Resolver Fraction Turns	Same as PNO 1811	DINT		Min to Max		NEVER	TECHNICIAN	1,4	04151
1813	Resolver Speed RPM	Parameters::Option IO::Resolver	REAL	x.x	Min to Max	RPM	NEVER	TECHNICIAN	4	04153
1814	Resolver Speed %	Same as PNO 1811	REAL	x.x	Min to Max	%	NEVER	TECHNICIAN	4	04155
1815	Resolver Speed Filter	Same as PNO 1790	REAL	1000	10 to 10000	%	ALWAYS	TECHNICIAN	4	04157
1816	Resolver Resolution	Same as PNO 1790	USINT (enum)	0	0:AUTO 1:12 BITS 2:14 BITS 3:16 BITS		STOPPED	TECHNICIAN	4	04159
1817	Resolver State	Parameters::Option IO::Resolver	USINT (enum)		0:POWER_ON 1:RESET 2:ACTIVE 3:TRIPPED 4:RESTART		NEVER	TECHNICIAN	4	04161
1818	Resolver Turns Reset	Parameters::Option IO::Resolver	BOOL	FALSE			ALWAYS	TECHNICIAN	2,4	04163
1819	Resolver Reset Power On	Parameters::Option IO::Resolver	BOOL	FALSE			STOPPED	TECHNICIAN	4	04165
1820	Resolver Trip Type	Parameters::Option IO::Resolver	USINT (enum)		0:NONE 1:PARITY 2:PHASE ERROR 3:MAX VELOCITY 4:TRACKING ERROR 5:SIN COS MISMATCH 6:SIN COS OVERRANGE 7:SIN COS BELOW LOS		NEVER	TECHNICIAN	4	04167

C-260 Parameter Reference

PNO	Name	Path	Type	Default	Range	Units	WQ	View	Notes	Mbus
1821	Resolver Speed Hz	Parameters::Option IO::Resolver	REAL	x.x	8:SIN COS CLIPPED	Hz	NEVER	TECHNICIAN	4	04169
1822	Resolver Built-In Gear	Same as PNO 1790	REAL	1.0	Min to Max		STOPPED	TECHNICIAN	4	04171
1823	Resolver Speed Ripple	Parameters::Option IO::Resolver	REAL	x.xx	0.00 to 1000.00	%	NEVER	TECHNICIAN	4	04173
1824	Resolver Position	Same as PNO 1811	INT		-32768 to 32767		NEVER	ENGINEER	1,4	04175
1825	Resolver Max Speed	Setup::Inputs and Outputs::Option Parameters::Option IO::Resolver	REAL	20000	0 to 120000	RPM	STOPPED	TECHNICIAN	4	04177
1826	Resolver Actual Filter	Parameters::Option IO::Resolver	REAL	x.	20 to 8000	Hz	NEVER	TECHNICIAN	4	04179
1827	Resolver Active Resol	Parameters::Option IO::Resolver	USINT (enum)		Same as PNO 1816		NEVER	ENGINEER	4	04181
1829	Copy to SD Card	Parameters::Trips::Black Box Recorder	BOOL	FALSE			ALWAYS	TECHNICIAN	4	04185
1830	Black Box PNOs	Parameters::Trips::Black Box Recorder	ARRAY[0..3]				ALWAYS	TECHNICIAN		04187
1831	Black Box PNOs[0]	Parameters::Trips::Black Box Recorder	UINT	0829	0000 to 3145		ALWAYS	TECHNICIAN		04189
1832	Black Box PNOs[1]	Parameters::Trips::Black Box Recorder	UINT	0514	0000 to 3145		ALWAYS	TECHNICIAN		04191
1833	Black Box PNOs[2]	Parameters::Trips::Black Box Recorder	UINT	1022	0000 to 3145		ALWAYS	TECHNICIAN		04193
1834	Black Box PNOs[3]	Parameters::Trips::Black Box Recorder	UINT	0393	0000 to 3145		ALWAYS	TECHNICIAN		04195
1835	Log Enable	Parameters::Device Manager::Data Logger	BOOL	FALSE			ALWAYS	TECHNICIAN		04197
1836	Log Period	Parameters::Device Manager::Data Logger	TIME	1.000	0.500 to 86400.000	s	ALWAYS	TECHNICIAN		04199
1837	Log File Name	Parameters::Device Manager::Data Logger	STRING[10]	logfile			ALWAYS	TECHNICIAN		04201
1838	Log to New File	Parameters::Device Manager::Data Logger	BOOL	FALSE			ALWAYS	TECHNICIAN	2	04203
1839	Log New File On Reset	Parameters::Device Manager::Data Logger	BOOL	FALSE			ALWAYS	TECHNICIAN		04205
1840	Limit Log File Size	Parameters::Device Manager::Data Logger	BOOL	FALSE			ALWAYS	TECHNICIAN		04207
1841	Log File Size	Parameters::Device Manager::Data Logger	UDINT		0 to Max		NEVER	TECHNICIAN		04209
1842	Log Parameters	Parameters::Device Manager::Data Logger	ARRAY[0..7]				ALWAYS	TECHNICIAN		04211
1843	Log Parameters[0]	Parameters::Device Manager::Data Logger	UINT	0000	0000 to 3145		ALWAYS	TECHNICIAN		04213
1844	Log Parameters[1]	Parameters::Device Manager::Data Logger	UINT	0000	0000 to 3145		ALWAYS	TECHNICIAN		04215
1845	Log Parameters[2]	Parameters::Device Manager::Data Logger	UINT	0000	0000 to 3145		ALWAYS	TECHNICIAN		04217
1846	Log Parameters[3]	Parameters::Device Manager::Data Logger	UINT	0000	0000 to 3145		ALWAYS	TECHNICIAN		04219
1847	Log Parameters[4]	Parameters::Device Manager::Data Logger	UINT	0000	0000 to 3145		ALWAYS	TECHNICIAN		04221
1848	Log Parameters[5]	Parameters::Device Manager::Data Logger	UINT	0000	0000 to 3145		ALWAYS	TECHNICIAN		04223
1849	Log Parameters[6]	Parameters::Device Manager::Data Logger	UINT	0000	0000 to 3145		ALWAYS	TECHNICIAN		04225
1850	Log Parameters[7]	Parameters::Device Manager::Data Logger	UINT	0000	0000 to 3145		ALWAYS	TECHNICIAN		04227
1851	Resolver Min Filter	Same as PNO 1825	REAL	100	10 to 1000	Hz	ALWAYS	TECHNICIAN	4	04229
1852	Copy Status	Parameters::Trips::Black Box Recorder	USINT (enum)		0:IDLE 1:ACTIVE 2:DISABLED		NEVER	OPERATOR	4	04231
1853	Comms Reset Allow	Setup::Communications::Option Parameters::Option Comms::Comms	BOOL	FALSE			ALWAYS	TECHNICIAN	4	04233
1854	Update GKP Text	Parameters::Keypad::Graphical Keypad	BOOL	FALSE			ALWAYS	TECHNICIAN	2	04235
1855	Encoder Speed Percent	Parameters::Option IO::Encoder	REAL	x.xx	Min to Max	%	NEVER	OPERATOR	4	04237
1856	Encoder Speed Percent	Parameters::System Board::SB Encoder Slot 1	REAL	x.xx	Min to Max	%	NEVER	OPERATOR	4	04239
1857	Encoder Speed Percent	Parameters::System Board::SB Encoder Slot 2	REAL	x.xx	Min to Max	%	NEVER	OPERATOR	4	04241
1858	Phase at Rated Current	Parameters::Motor Control::PMAC Motor Advanced	REAL	0.0	0.0 to 90.0	deg	STOPPED	ENGINEER	6,4	04243
1859	Max Phase	Parameters::Motor Control::PMAC Motor Advanced	REAL	0.0	0.0 to 90.0	deg	STOPPED	ENGINEER	6,4	04245
1861	Scaled PNO Access	Parameters::Device Manager::Setup Wizard	USINT (enum)	0	0:BASE UNITS 1:SELECTED UNITS		ALWAYS	TECHNICIAN		04249
1862	Green LED Force On	Parameters::Keypad::Keypad Override	BOOL	FALSE			ALWAYS	TECHNICIAN	2	04251
1863	Red LED Force Off	Parameters::Keypad::Keypad Override	BOOL	FALSE			ALWAYS	TECHNICIAN	2	04253
1865	Disable Keys	Parameters::Keypad::Keypad Override	WORD	0000			ALWAYS	TECHNICIAN	2	04257
1866	Key Press	Parameters::Keypad::Keypad Override	WORD				NEVER	TECHNICIAN		04259
1867	Selected Parameter	Parameters::Keypad::Keypad Override	UINT		0000 to 3145		NEVER	TECHNICIAN		04261
1868	Log Now	Parameters::Device Manager::Data Logger	BOOL	FALSE			ALWAYS	TECHNICIAN	2	04263
1869	Auto Defaults	Parameters::Device Manager::Drive info	BOOL	FALSE			ALWAYS	TECHNICIAN		04265
1870	Z Pulse	Setup::Inputs and Outputs::System Board Option Parameters::System Board::SB Retransmit	BOOL	FALSE			ALWAYS	TECHNICIAN	2,4	04267
1871	Synth Encoder Count	Monitor::System Board::Synthetic Encoder Parameters::System Board::SB Retransmit	DINT		Min to Max		NEVER	TECHNICIAN	1,4	04269
1872	Z Pulse Init Done	Parameters::System Board::SB Retransmit	BOOL				NEVER	ENGINEER	4	04271
1874	Encoder Supply	Setup::Inputs and Outputs::SB Encoder Parameters::System Board::SB Encoder	USINT (enum)	0	0:5V 1:10V		STOPPED	TECHNICIAN	4	04275
1875	Encoder Type	Same as PNO 1874	USINT (enum)	0	0:SIN COS 1:ENDAT 2.1 ST 2:ENDAT 2.1 MT		STOPPED	TECHNICIAN	4	04277

Parameter Reference C-261

PNO	Name	Path	Type	Default	Range	Units	WQ	View	Notes	Mbus
1876	Encoder Lines	Same as PNO 1874	DINT	512	1 to 1048576		STOPPED	TECHNICIAN	4	04279
1877	Encoder Invert	Same as PNO 1874	BOOL	FALSE			STOPPED	TECHNICIAN	4	04281
1878	Encoder Count	Monitor::System Board::SB Encoder Parameters::System Board::SB Encoder	DINT		Min to Max		NEVER	TECHNICIAN	1,4	04283
1879	Encoder Rev Count	Same as PNO 1878	DINT		Min to Max		NEVER	TECHNICIAN	1,4	04285
1885	Startup Alignment	Setup::Motor Control::Control and Type Parameters::Control Mode::Control Mode	USINT (enum)	0	0:DISABLED 1:ONCE 2:ALWAYS		ALWAYS	TECHNICIAN	4	04297
1886	Actual Control Type	Monitor::Motor and Drive Parameters::Control Mode::Control Mode	USINT (enum)		Same as PNO 1533		NEVER	ENGINEER	4	04299
1887	Start Align Done	Same as PNO 1886	BOOL				NEVER	TECHNICIAN	4	04301
1891	SNTP Server Enable	Parameters::Base Comms::SNTP Server	BOOL	FALSE			ALWAYS	TECHNICIAN		04309
1892	Encoder Speed	Same as PNO 1878	REAL	x.	Min to Max	RPM	NEVER	OPERATOR	4	04311
1893	Encoder Speed Percent	Parameters::System Board::SB Encoder	REAL	x.xx	Min to Max	%	NEVER	OPERATOR	4	04313
1894	Motor Count Reset	Same as PNO 1874	BOOL	FALSE			ALWAYS	TECHNICIAN	2,4	04315
1895	Calibration Error	Parameters::System Board::SB Encoder	USINT (enum)		0:NONE 1:MOTOR NOT STOPPED 2:ENDAT TIMEOUT 3:ENDAT READ 4:ENDAT CHECKSUM FAIL 5:SINCOS AND ENDAT POS1 6:SINCOS AND ENDAT POS2 7:SINCOS AND ENDAT POS3 8:SINCOS AND ENDAT POS4 9:SINCOS AND ENDAT POS5 10:SINCOS AND ENDAT POS6 11:TIMEOUT 12:MASK CREATION 13:HW MISMATCH1 14:HW MISMATCH2 15:FAULTY ENCODER 16:WRONG ENCODER LINES 17:WRONG ENCODER TYPE 18:WARNING		NEVER	TECHNICIAN	4	04317
1896	Absolute Calib Status	Parameters::System Board::SB Encoder	USINT (enum)		0:CAL NOT REQUIRED 1:DRIVE NOT STOPPED 2:MOTOR NOT STOPPED 3:ENDAT FAULT 4:CALIB IN PROGRESS 5:RECOVERING LOAD POS 6:CALIB COMPLETED 7:CALIB LOST 8:CALIB FAILED 9:CALIB WARNING		NEVER	TECHNICIAN	4	04319
1897	Calib Fail Retry	Same as PNO 1874	BOOL	FALSE			STOPPED	TECHNICIAN	2,4	04321
1898	Motor Count	Parameters::System Board::SB Encoder	DINT		Min to Max		NEVER	TECHNICIAN	1,4	04323
3000	Input Mapping	Setup::Communications::Base EtherNet IP Parameters::Base Comms::Fieldbus Mapping	ARRAY[0..31]				CONFIG	ENGINEER		06527
3001	Input Mapping[0]	Same as PNO 3000	UINT	0627	0000 to 3145		CONFIG	ENGINEER		06529
3002	Input Mapping[1]	Same as PNO 3000	UINT	0681	0000 to 3145		CONFIG	ENGINEER		06531
3003	Input Mapping[2]	Same as PNO 3000	UINT	0000	0000 to 3145		CONFIG	ENGINEER		06533
3004	Input Mapping[3]	Same as PNO 3000	UINT	0000	0000 to 3145		CONFIG	ENGINEER		06535
3005	Input Mapping[4]	Same as PNO 3000	UINT	0000	0000 to 3145		CONFIG	ENGINEER		06537
3006	Input Mapping[5]	Same as PNO 3000	UINT	0000	0000 to 3145		CONFIG	ENGINEER		06539
3007	Input Mapping[6]	Same as PNO 3000	UINT	0000	0000 to 3145		CONFIG	ENGINEER		06541
3008	Input Mapping[7]	Same as PNO 3000	UINT	0000	0000 to 3145		CONFIG	ENGINEER		06543
3009	Input Mapping[8]	Same as PNO 3000	UINT	0000	0000 to 3145		CONFIG	ENGINEER		06545
3010	Input Mapping[9]	Same as PNO 3000	UINT	0000	0000 to 3145		CONFIG	ENGINEER		06547
3011	Input Mapping[10]	Same as PNO 3000	UINT	0000	0000 to 3145		CONFIG	ENGINEER		06549
3012	Input Mapping[11]	Same as PNO 3000	UINT	0000	0000 to 3145		CONFIG	ENGINEER		06551
3013	Input Mapping[12]	Same as PNO 3000	UINT	0000	0000 to 3145		CONFIG	ENGINEER		06553
3014	Input Mapping[13]	Same as PNO 3000	UINT	0000	0000 to 3145		CONFIG	ENGINEER		06555
3015	Input Mapping[14]	Same as PNO 3000	UINT	0000	0000 to 3145		CONFIG	ENGINEER		06557
3016	Input Mapping[15]	Same as PNO 3000	UINT	0000	0000 to 3145		CONFIG	ENGINEER		06559
3017	Input Mapping[16]	Same as PNO 3000	UINT	0000	0000 to 3145		CONFIG	ENGINEER		06561
3018	Input Mapping[17]	Same as PNO 3000	UINT	0000	0000 to 3145		CONFIG	ENGINEER		06563
3019	Input Mapping[18]	Same as PNO 3000	UINT	0000	0000 to 3145		CONFIG	ENGINEER		06565

C-262 Parameter Reference

PNO	Name	Path	Type	Default	Range	Units	WQ	View	Notes	Mbus
3020	Input Mapping[19]	Same as PNO 3000	UINT	0000	0000 to 3145		CONFIG	ENGINEER		06567
3021	Input Mapping[20]	Same as PNO 3000	UINT	0000	0000 to 3145		CONFIG	ENGINEER		06569
3022	Input Mapping[21]	Same as PNO 3000	UINT	0000	0000 to 3145		CONFIG	ENGINEER		06571
3023	Input Mapping[22]	Same as PNO 3000	UINT	0000	0000 to 3145		CONFIG	ENGINEER		06573
3024	Input Mapping[23]	Same as PNO 3000	UINT	0000	0000 to 3145		CONFIG	ENGINEER		06575
3025	Input Mapping[24]	Same as PNO 3000	UINT	0000	0000 to 3145		CONFIG	ENGINEER		06577
3026	Input Mapping[25]	Same as PNO 3000	UINT	0000	0000 to 3145		CONFIG	ENGINEER		06579
3027	Input Mapping[26]	Same as PNO 3000	UINT	0000	0000 to 3145		CONFIG	ENGINEER		06581
3028	Input Mapping[27]	Same as PNO 3000	UINT	0000	0000 to 3145		CONFIG	ENGINEER		06583
3029	Input Mapping[28]	Same as PNO 3000	UINT	0000	0000 to 3145		CONFIG	ENGINEER		06585
3030	Input Mapping[29]	Same as PNO 3000	UINT	0000	0000 to 3145		CONFIG	ENGINEER		06587
3031	Input Mapping[30]	Same as PNO 3000	UINT	0000	0000 to 3145		CONFIG	ENGINEER		06589
3032	Input Mapping[31]	Same as PNO 3000	UINT	0000	0000 to 3145		CONFIG	ENGINEER		06591
3064	Output Mapping	Setup::Communications::Base EtherNet IP Parameters::Base Comms::Fieldbus Mapping	ARRAY[0..31]				CONFIG	ENGINEER		06655
3065	Output Mapping[0]	Same as PNO 3064	UINT	0661	0000 to 3145		CONFIG	ENGINEER		06657
3066	Output Mapping[1]	Same as PNO 3064	UINT	0395	0000 to 3145		CONFIG	ENGINEER		06659
3067	Output Mapping[2]	Same as PNO 3064	UINT	0000	0000 to 3145		CONFIG	ENGINEER		06661
3068	Output Mapping[3]	Same as PNO 3064	UINT	0000	0000 to 3145		CONFIG	ENGINEER		06663
3069	Output Mapping[4]	Same as PNO 3064	UINT	0000	0000 to 3145		CONFIG	ENGINEER		06665
3070	Output Mapping[5]	Same as PNO 3064	UINT	0000	0000 to 3145		CONFIG	ENGINEER		06667
3071	Output Mapping[6]	Same as PNO 3064	UINT	0000	0000 to 3145		CONFIG	ENGINEER		06669
3072	Output Mapping[7]	Same as PNO 3064	UINT	0000	0000 to 3145		CONFIG	ENGINEER		06671
3073	Output Mapping[8]	Same as PNO 3064	UINT	0000	0000 to 3145		CONFIG	ENGINEER		06673
3074	Output Mapping[9]	Same as PNO 3064	UINT	0000	0000 to 3145		CONFIG	ENGINEER		06675
3075	Output Mapping[10]	Same as PNO 3064	UINT	0000	0000 to 3145		CONFIG	ENGINEER		06677
3076	Output Mapping[11]	Same as PNO 3064	UINT	0000	0000 to 3145		CONFIG	ENGINEER		06679
3077	Output Mapping[12]	Same as PNO 3064	UINT	0000	0000 to 3145		CONFIG	ENGINEER		06681
3078	Output Mapping[13]	Same as PNO 3064	UINT	0000	0000 to 3145		CONFIG	ENGINEER		06683
3079	Output Mapping[14]	Same as PNO 3064	UINT	0000	0000 to 3145		CONFIG	ENGINEER		06685
3080	Output Mapping[15]	Same as PNO 3064	UINT	0000	0000 to 3145		CONFIG	ENGINEER		06687
3081	Output Mapping[16]	Same as PNO 3064	UINT	0000	0000 to 3145		CONFIG	ENGINEER		06689
3082	Output Mapping[17]	Same as PNO 3064	UINT	0000	0000 to 3145		CONFIG	ENGINEER		06691
3083	Output Mapping[18]	Same as PNO 3064	UINT	0000	0000 to 3145		CONFIG	ENGINEER		06693
3084	Output Mapping[19]	Same as PNO 3064	UINT	0000	0000 to 3145		CONFIG	ENGINEER		06695
3085	Output Mapping[20]	Same as PNO 3064	UINT	0000	0000 to 3145		CONFIG	ENGINEER		06697
3086	Output Mapping[21]	Same as PNO 3064	UINT	0000	0000 to 3145		CONFIG	ENGINEER		06699
3087	Output Mapping[22]	Same as PNO 3064	UINT	0000	0000 to 3145		CONFIG	ENGINEER		06701
3088	Output Mapping[23]	Same as PNO 3064	UINT	0000	0000 to 3145		CONFIG	ENGINEER		06703
3089	Output Mapping[24]	Same as PNO 3064	UINT	0000	0000 to 3145		CONFIG	ENGINEER		06705
3090	Output Mapping[25]	Same as PNO 3064	UINT	0000	0000 to 3145		CONFIG	ENGINEER		06707
3091	Output Mapping[26]	Same as PNO 3064	UINT	0000	0000 to 3145		CONFIG	ENGINEER		06709
3092	Output Mapping[27]	Same as PNO 3064	UINT	0000	0000 to 3145		CONFIG	ENGINEER		06711
3093	Output Mapping[28]	Same as PNO 3064	UINT	0000	0000 to 3145		CONFIG	ENGINEER		06713
3094	Output Mapping[29]	Same as PNO 3064	UINT	0000	0000 to 3145		CONFIG	ENGINEER		06715
3095	Output Mapping[30]	Same as PNO 3064	UINT	0000	0000 to 3145		CONFIG	ENGINEER		06717
3096	Output Mapping[31]	Same as PNO 3064	UINT	0000	0000 to 3145		CONFIG	ENGINEER		06719
3128	EtherNet IP Enable	Setup::Communications::Base EtherNet IP Parameters::Base Comms::EtherNet IP Adapter	BOOL	FALSE			CONFIG	TECHNICIAN		06783
3129	EtherNet IP Trip	Same as PNO 3128	USINT (enum)	1	0:DISABLED 1:LOSS OF CONNECTION		CONFIG	ENGINEER		06785
3130	EtherNet IP State	Monitor::Communications::Base EtherNet IP Parameters::Base Comms::EtherNet IP Adapter	USINT (enum)		Same as PNO 214		NEVER	OPERATOR		06787
3131	EtherNet IP Diag	Same as PNO 3130	USINT (enum)		0:NONE 1:INPUT MAPPING FAILED 2:OUTPUT MAPPING FAILED		NEVER	OPERATOR		06789
3132	PROFINET Enable	Setup::Communications::Base PROFINET Parameters::Base Comms::PROFINET IO Device	BOOL	FALSE			CONFIG	TECHNICIAN		06791
3133	PROFINET Trip	Same as PNO 3132	USINT (enum)	1	0:DISABLED 1:ENABLED		CONFIG	ENGINEER		06793
3134	PROFINET Use Drive IP	Same as PNO 3132	BOOL	FALSE			CONFIG	ENGINEER		06795
3135	PROFINET Acyclic Endn	Same as PNO 3132	USINT (enum)	1	0:LITTLE ENDIAN 1:BIG ENDIAN		ALWAYS	ENGINEER		06797
3136	PROFINET Station Name	Monitor::Communications::Base PROFINET Parameters::Base Comms::PROFINET IO	STRING[21]				NEVER	OPERATOR		06799

Parameter Reference C-263

PNO	Name	Path	Type	Default	Range	Units	WQ	View	Notes	MBus
		Device								
3143	PROFINET State	Same as PNO 3136	USINT (enum)		Same as PNO 239		NEVER	OPERATOR		06813
3144	PROFINET Diagnostic	Same as PNO 3136	USINT (enum)		0:NONE 1:INPUT MAPPING FAILED 2:OUTPUT MAPPING FAILED 3:CONNECTION REJECTED 4:MAPPING MISMATCH		NEVER	OPERATOR		06815

C-264 Parameter Reference

Parameters Defined in the Default Application

PNO	Name	Path	Type	Default	Range	Units	WQ	View	Notes	Mbus
1900	Selected Application		USINT (enum)	0	0:BASIC SPEED CONTROL 1:AUTO/MANUAL CONTROL 2:SPEED RAISE / LOWER 3:SPEED PRESETS 4:PROCESS PID		ALWAYS	TECHNICIAN	5	04327
1901	RL Ramp Time	Setup::Application::Raise Lower	TIME	10.0	0.0 to 600.0	s	ALWAYS	TECHNICIAN	5,8	04329
1902	RL Reset Value	Setup::Application::Raise Lower	REAL	0.0	-500.0 to 500.0	%	ALWAYS	TECHNICIAN	5,8	04331
1903	RL Maximum Value	Setup::Application::Raise Lower	REAL	100.0	-500.0 to 500.0	%	ALWAYS	TECHNICIAN	5,8	04333
1904	RL Minimum Value	Setup::Application::Raise Lower	REAL	-100.0	-500.0 to 500.0	%	ALWAYS	TECHNICIAN	5,8	04335
1905	Raise Lower Output	Monitor::Application::Raise Lower	REAL	0.0	-500.0 to 500.0		NEVER	TECHNICIAN	1,8	04337
1906	Minimum Speed Value	Setup::Application::Minimum Speed	REAL	-100.0	-100.0 to 100.0	%	ALWAYS	TECHNICIAN	5,8	04339
1907	Minimum Speed Mode	Setup::Application::Minimum Speed	USINT (enum)	0	0:PROP WITH MINIMUM 1:LINEAR		ALWAYS	TECHNICIAN	5,8	04341
1908	Skip Band 1	Setup::Application::Skip Frequencies	REAL	0.0	0.0 to 1000.0	Hz	ALWAYS	TECHNICIAN	5,8	04343
1909	Skip Frequency 1	Setup::Application::Skip Frequencies	REAL	0.0	0.0 to 1000.0	Hz	ALWAYS	TECHNICIAN	5,8	04345
1910	Skip Band 2	Setup::Application::Skip Frequencies	REAL	0.0	0.0 to 1000.0	Hz	ALWAYS	TECHNICIAN	5,8	04347
1911	Skip Frequency 2	Setup::Application::Skip Frequencies	REAL	0.0	0.0 to 1000.0	Hz	ALWAYS	TECHNICIAN	5,8	04349
1912	Skip Band 3	Setup::Application::Skip Frequencies	REAL	0.0	0.0 to 1000.0	Hz	ALWAYS	TECHNICIAN	5,8	04351
1913	Skip Frequency 3	Setup::Application::Skip Frequencies	REAL	0.0	0.0 to 1000.0	Hz	ALWAYS	TECHNICIAN	5,8	04353
1914	Skip Band 4	Setup::Application::Skip Frequencies	REAL	0.0	0.0 to 1000.0	Hz	ALWAYS	TECHNICIAN	5,8	04355
1915	Skip Frequency 4	Setup::Application::Skip Frequencies	REAL	0.0	0.0 to 1000.0	Hz	ALWAYS	TECHNICIAN	5,8	04357
1916	Preset Speed 0	Setup::Application::Preset Speeds	REAL	0.0	-100.0 to 100.0	%	ALWAYS	TECHNICIAN	5,8	04359
1917	Preset Speed 1	Setup::Application::Preset Speeds	REAL	0.0	-100.0 to 100.0	%	ALWAYS	TECHNICIAN	5,8	04361
1918	Preset Speed 2	Setup::Application::Preset Speeds	REAL	0.0	-100.0 to 100.0	%	ALWAYS	TECHNICIAN	5,8	04363
1919	Preset Speed 3	Setup::Application::Preset Speeds	REAL	0.0	-100.0 to 100.0	%	ALWAYS	TECHNICIAN	5,8	04365
1920	Preset Speed 4	Setup::Application::Preset Speeds	REAL	0.0	-100.0 to 100.0	%	ALWAYS	TECHNICIAN	5,8	04367
1921	Preset Speed 5	Setup::Application::Preset Speeds	REAL	0.0	-100.0 to 100.0	%	ALWAYS	TECHNICIAN	5,8	04369
1922	Preset Speed 6	Setup::Application::Preset Speeds	REAL	0.0	-100.0 to 100.0	%	ALWAYS	TECHNICIAN	5,8	04371
1923	Preset Speed 7	Setup::Application::Preset Speeds	REAL	0.0	-100.0 to 100.0	%	ALWAYS	TECHNICIAN	5,8	04373
1924	Selected Preset	Monitor::Application::Preset Speeds	USINT		0 to 7		NEVER	TECHNICIAN	8	04375
1925	Preset Speed Output	Monitor::Application::Preset Speeds	REAL		-100.0 to 100.0	%	NEVER	TECHNICIAN	8	04377
1926	PID Setpoint Negate	Setup::Application::PID	BOOL	TRUE	ALWAYS		TECHNICIAN	5,8	04379	
1927	PID Feedback Negate	Setup::Application::PID	BOOL	TRUE	ALWAYS		TECHNICIAN	5,8	04381	
1928	PID Proportional Gain	Setup::Application::PID	REAL	1.0	ALWAYS		TECHNICIAN	5,8	04383	
1929	PID Integral TC	Setup::Application::PID	TIME	1.00	0.01 to 100.00	s	ALWAYS	TECHNICIAN	5,8	04385
1930	PID Derivative TC	Setup::Application::PID	TIME	0.000	0.000 to 10.000	s	ALWAYS	TECHNICIAN	5,8	04387
1931	PID Output Filter TC	Setup::Application::PID	TIME	0.100	0.000 to 10.000	s	ALWAYS	TECHNICIAN	5,8	04389
1932	PID Output Pos Limit	Setup::Application::PID	REAL	100.00	0.00 to 105.00	%	ALWAYS	TECHNICIAN	5,8	04391
1933	PID Output Neg Limit	Setup::Application::PID	REAL	-100.00	-105.00 to 0.00	%	ALWAYS	TECHNICIAN	5,8	04393
1934	PID Output Scaling	Setup::Application::PID	REAL	1.000	-10.000 to 10.000		ALWAYS	TECHNICIAN	5,8	04395
1935	PID Output	Monitor::Application::PID	REAL	-105.00 to 105.00	%		NEVER	TECHNICIAN	8	04397
1936	PID Error	Monitor::Application::PID	REAL	-105.00 to 105.00	%		NEVER	TECHNICIAN	8	04399
1937	Disable Coast Stop	Setup::Application::Sequencing	BOOL	TRUE			ALWAYS	TECHNICIAN	8	04401
1938	Disable Quickstop	Setup::Application::Sequencing	BOOL	TRUE			ALWAYS	TECHNICIAN	8	04403
1939	Feedback On ANIN1	Setup::Application::Input Selection	BOOL	FALSE			ALWAYS	TECHNICIAN	8	04405

Table of Parameters in Alphabetical Order

This table is a list of all the parameters in the AC30V showing the parameter name, number and the section in this appendix in which the parameter is described.

PNO	Name	Section
0332	100% Mot Current	Motor Load
0464	100% Speed in RPM	Scale Setpoint
0403	100% Stack Current A	Feedbacks
0343	100% Stk Current	Stack Inv Time
1896	Absolute Calib Status	SB Encoder
0450	Acceleration Boost	Fluxing VHz
0486	Acceleration Time	Ramp
0763	Active 1 - 32	Trips Status
0513	Active 33 - 64	Trips Status
1886	Actual Control Type	Control Mode
0400	Actual Field Current	Feedbacks
0339	Actual Mot I2T Output	Motor Load
0421	Actual Neg Torque Lim	Torque Limit
0420	Actual Pos Torque Lim	Torque Limit
1213	Actual Position	Feedbacks
1520	Actual Rotor T Const	Tr Adaptation
0395	Actual Speed Percent	Feedbacks
0393	Actual Speed RPM	Feedbacks
0394	Actual Speed rps	Feedbacks
0989	Actual State	Device State
0399	Actual Torque	Feedbacks
0199	Address Assignment	Option Ethernet
1716	AFE Brake Mode	AFE
1690	AFE Close Ext PCR	AFE
1717	AFE Correction Angle	AFE
1693	AFE Current Control	AFE
1714	AFE Enable Drive	AFE
1691	AFE Ext PCR Closed	AFE
1704	AFE Id Demand	AFE
1730	AFE Inductance	AFE
1705	AFE Iq Demand	AFE
1706	AFE Max Current	AFE
1692	AFE PF Angle Demand	AFE
1715	AFE Phase Loss	AFE
1694	AFE PLL Kp	AFE
1695	AFE PLL Ti	AFE
1721	AFE Status	AFE
1718	AFE Sync Angle	AFE
1703	AFE Sync Frequency	AFE
1713	AFE Synchronized	AFE
1712	AFE Synchronizing	AFE
1731	AFE Transf Angle Offset	AFE
1711	AFE VDC Demand	AFE
1710	AFE VDC Feed Forward	AFE
1707	AFE VDC Kp	AFE
1697	AFE VDC Min Level	AFE
1709	AFE VDC Ramp	AFE
1708	AFE VDC Ti	AFE
1804	Alignment Direction	Pos Fbk Alignment
1803	Alignment Elec Pos	Pos Fbk Alignment
1798	Alignment Enable	Pos Fbk Alignment

PNO	Name	Section
1806	Alignment Ended	Pos Fbk Alignment
1807	Alignment Error	Pos Fbk Alignment
1799	Alignment Level	Pos Fbk Alignment
1797	Alignment Method	Pos Fbk Alignment
1802	Alignment Offset	Pos Fbk Alignment
1801	Alignment On Motor	Pos Fbk Alignment
1796	Alignment On Power On	Pos Fbk Alignment
1800	Alignment Ramp Time	Pos Fbk Alignment
1805	Alignment State	Pos Fbk Alignment
0893	Ambient Temperature	Maintenance Monitor
0040	Anin 01 Break	IO Values
0957	Anin 01 Offset	IO Configure
0958	Anin 01 Scale	IO Configure
0001	Anin 01 Type	IO Configure
0039	Anin 01 Value	IO Values
0959	Anin 02 Offset	IO Configure
0960	Anin 02 Scale	IO Configure
0002	Anin 02 Type	IO Configure
0041	Anin 02 Value	IO Values
1461	Anin 11 Offset	General Purpose IO
1462	Anin 11 Scale	General Purpose IO
1181	Anin 11 Value	General Purpose IO
1463	Anin 12 Offset	General Purpose IO
1464	Anin 12 Scale	General Purpose IO
1182	Anin 12 Value	General Purpose IO
1465	Anin 13 Offset	General Purpose IO
1466	Anin 13 Scale	General Purpose IO
1183	Anin 13 Value	General Purpose IO
1441	Anout 01 ABS	IO Configure
1108	Anout 01 Offset	IO Configure
0686	Anout 01 Scale	IO Configure
0003	Anout 01 Type	IO Configure
0042	Anout 01 Value	IO Values
1468	Anout 02 ABS	IO Configure
1467	Anout 02 Offset	IO Configure
1460	Anout 02 Scale	IO Configure
0004	Anout 02 Type	IO Configure
0043	Anout 02 Value	IO Values
0610	App Control Word	Sequencing
0680	App Reference	Sequencing
1539	Application	Clone
1039	Application Archive	SD Card
0990	Application FE State	Device State
1554	Application Name	App Info
1633	Application User Boost	Fluxing VHz
1549	Application Volts	Fluxing VHz
1507	AR Active	Auto Restart
1469	AR Enable	Auto Restart
1505	AR Initial Delay	Auto Restart
1736	AR Initial Delay B	Auto Restart
1471	AR Max Restarts	Auto Restart

PNO	Name	Section
1470	AR Mode	Auto Restart
1506	AR Repeat Delay	Auto Restart
1737	AR Repeat Delay B	Auto Restart
1508	AR Restart Pending	Auto Restart
1509	AR Restarts Remaining	Auto Restart
1510	AR Time Remaining	Auto Restart
1472	AR Trip Mask	Auto Restart
0796	AR Trip Mask 2	Auto Restart
1735	AR Trip Mask 2 B	Auto Restart
1734	AR Trip Mask B	Auto Restart
0410	Archive Flags	App Info
1405	ATN PMAC Ls Test Freq	Autotune
1388	ATN PMAC Test Disable	Autotune
0695	Attached to Stack	Drive info
0448	Auto Boost	Fluxing VHz
1869	Auto Defaults	Drive info
1779	Auto Hide	Setup Wizard
0930	Auto IP	Ethernet
1214	Automatic Pole Pairs	Motor Nameplate
0255	Autotune Enable	Autotune
0256	Autotune Mode	Autotune
0274	Autotune Ramp Time	Autotune
0257	Autotune Test Disable	Autotune
0182	Backup Action	Parameter Backup
0183	Backup-Restore Start	Parameter Backup
0184	Backup-Restore Status	Parameter Backup
1093	BACnet Baud Rate	BACnet MSTP
0209	BACnet IP Device ID	BACnet IP
0208	BACnet IP State	BACnet IP
0210	BACnet IP Timeout	BACnet IP
1091	BACnet MAC Address	BACnet MSTP
1096	BACnet Max Info Frames	BACnet MSTP
1095	BACnet Max Master	BACnet MSTP
1092	BACnet MSTP Device ID	BACnet MSTP
1089	BACnet MSTP State	BACnet MSTP
1094	BACnet MSTP Timeout	BACnet MSTP
0457	Base Frequency	Motor Nameplate
0991	Base IO FE State	Device State
0456	Base Voltage	Motor Nameplate
0992	Basic Drive FE State	Device State
1830	Black Box PNOs	Black Box Recorder
1831	Black Box PNOs[x]	Black Box Recorder
0951	Boot Version	Drive info
0687	Boot Version Number	Drive info
0253	Brake Overrating	Braking
0252	Brake Rated Power	Braking
0251	Brake Resistance	Braking
0254	Braking Active	Braking
0249	Braking Enable	Braking
1897	Calib Fail Retry	SB Encoder
1895	Calibration Error	SB Encoder

C-266 Parameter Reference

PNO	Name	Section
1251	CANopen Actual Baud	CANopen
0213	CANopen Baud Rate	CANopen
0212	CANopen Node Address	CANopen
0211	CANopen State	CANopen
1034	Card Name	SD Card
1033	Card State	SD Card
1537	Clone Direction	Clone
1534	Clone Filename	Clone
1542	Clone Start	Clone
1543	Clone Status	Clone
0406	CM Temperature	Feedbacks
0217	CNet Consuming Inst	ControlNet
0216	CNet Producing Inst	ControlNet
0627	Comms Control Word	Sequencing
0051	Comms Diagnostic	Comms
0052	Comms Diagnostic Code	Comms
0186	Comms Event Active	Event
0188	Comms Event Clear	Event
0185	Comms Event Code	Event
0187	Comms Event Set	Event
0053	Comms Exception	Comms
0045	Comms Fitted	Comms
0050	Comms Module Serial	Comms
0049	Comms Module Version	Comms
0054	Comms Net Exception	Comms
0995	Comms Option FE State	Device State
1121	Comms Option Pcode	Drive info
1129	Comms Option Serial	Drive info
0681	Comms Reference	Sequencing
0044	Comms Required	Comms
1853	Comms Reset Allow	Comms
0046	Comms State	Comms
0047	Comms Supervised	Comms
0048	Comms Trip Enable	Comms
0997	Config Fault Area	Device State
0118	Configuration Lock	App Info
1139	Control Board Up Time	Runtime Statistics
1116	Control Module Pcode	Drive info
0977	Control Module Serial	Drive info
1352	Control Screen	Soft Menus
0908	Control Screen Mode	Soft Menus
1353	Control Screen[x]	Soft Menus
0512	Control Strategy	Control Mode
1533	Control Type	Control Mode
0644	Control Word	Sequencing
0215	ControlNet MAC ID	ControlNet
0214	ControlNet State	ControlNet
1852	Copy Status	Black Box Recorder
1829	Copy to SD Card	Black Box Recorder
1658	Current Diff Level	Current Sensor Trip
0305	Current Limit	Current Limit
1545	Cut Off Frequency	Filter On Torque Dmd
0329	DC Current Level	Inj Braking
0331	DC Inj Base Volts	Inj Braking
0326	DC Inj Current Limit	Inj Braking
0324	DC Inj Deflux Time	Inj Braking

PNO	Name	Section
0325	DC Inj Frequency	Inj Braking
0330	DC Inj Timeout	Inj Braking
0396	DC Link Volt Filtered	Feedbacks
0392	DC Link Voltage	Feedbacks
0119	DC Link Volts Trim	Feedbacks
0327	DC Pulse Time	Inj Braking
0487	Deceleration Time	Ramp
0414	Deflux Delay	Pattern Generator
1635	Delay To Start	Motor Sequencer
1528	Demanded Terminal Volts	Tr Adaptation
1726	Destination IP Address	Peer to Peer
1727	Destination Port	Peer to Peer
0221	DeviceNet Actual Baud	DeviceNet
0220	DeviceNet Baud Rate	DeviceNet
0219	DeviceNet MAC ID	DeviceNet
0218	DeviceNet State	DeviceNet
0929	DHCP	Ethernet
1269	DHCP State	Ethernet
1294	Digin Invert	IO Configure
0005	Digin Value	IO Values
1335	Digout Invert	IO Configure
0022	Digout Value	IO Values
0531	Direct Input Neg Lim	Spd Direct Input
0530	Direct Input Pos Lim	Spd Direct Input
0529	Direct Input Ratio	Spd Direct Input
0528	Direct Input Select	Spd Direct Input
1865	Disable Keys	Keypad Override
0983	Display Timeout	Graphical Keypad
1760	Display Warnings	Trips Status
0223	DNet Consuming Inst	DeviceNet
0222	DNet Producing Inst	DeviceNet
0688	Drive Diagnostic	Drive info
0961	Drive Name	Drive info
1225	DST Active	Real Time Clock
0390	Duty Selection	Feedbacks
0408	Elec Rotor Speed	Feedbacks
0697	Enable 1 - 32	Trips Status
0730	Enable 33 - 64	Trips Status
1738	Enable Auto Save	Setup Wizard
0955	Enable Predict Term	Current Loop
1231	Enc To Mot Shaft Ratio	SB Encoder
1518	Encoder Count	Encoder
1670	Encoder Count	SB Encoder Slot 1
1677	Encoder Count	SB Encoder Slot 2
1878	Encoder Count	SB Encoder
1783	Encoder Count Init	Encoder
1784	Encoder Count Init	SB Encoder Slot 1
1785	Encoder Count Init	SB Encoder Slot 2
1517	Encoder Count Reset	Encoder
1669	Encoder Count Reset	SB Encoder Slot 1
1676	Encoder Count Reset	SB Encoder Slot 2
1743	Encoder Feedback	Control Mode
1513	Encoder Invert	Encoder
1665	Encoder Invert	SB Encoder Slot 1
1672	Encoder Invert	SB Encoder Slot 2
1877	Encoder Invert	SB Encoder

PNO	Name	Section
1512	Encoder Lines	Encoder
1664	Encoder Lines	SB Encoder Slot 1
1671	Encoder Lines	SB Encoder Slot 2
1876	Encoder Lines	SB Encoder
1310	Encoder Position	SB Encoder
1879	Encoder Rev Count	SB Encoder
1515	Encoder Single Ended	Encoder
1516	Encoder Speed	Encoder
1668	Encoder Speed	SB Encoder Slot 1
1675	Encoder Speed	SB Encoder Slot 2
1892	Encoder Speed	SB Encoder
1855	Encoder Speed Percent	Encoder
1856	Encoder Speed Percent	SB Encoder Slot 1
1857	Encoder Speed Percent	SB Encoder Slot 2
1893	Encoder Speed Percent	SB Encoder
1232	Encoder Status	SB Encoder
1511	Encoder Supply	Encoder
1663	Encoder Supply	SB Encoder Slot 1
1874	Encoder Supply	SB Encoder
1514	Encoder Type	Encoder
1666	Encoder Type	SB Encoder Slot 1
1673	Encoder Type	SB Encoder Slot 2
1875	Encoder Type	SB Encoder
1235	Endat Comms Status	SB Encoder
0383	Energy kWh	Energy Meter
0451	Energy Saving Enable	Fluxing VHz
1526	Energy Saving Lower Lim	Fluxing VHz
0227	ENet Consuming Inst	EtherNet IP
0226	ENet Producing Inst	EtherNet IP
1637	Engineer Password	Graphical Keypad
1750	Error Number	Configure
0224	EtherCAT State	EtherCAT
0937	Ethernet Diagnostic	Ethernet
0993	Ethernet FE State	Device State
0225	EtherNet IP State	EtherNet IP
0919	Ethernet State	Ethernet
0117	Extended Support	SD Card
1548	Factor	Filter On Torque Dmd
0418	Fast Stop Torque Lim	Torque Limit
1188	Favourites	Soft Menus
1189	Favourites[x]	Soft Menus
1544	Filter Type	Filter On Torque Dmd
0918	Filtered VDC Ripple	VDC Ripple
0328	Final DC Pulse Time	Inj Braking
0509	Final Stop Rate	Ramp
1038	Firmware	SD Card
1100	Firmware Version	Drive info
0696	First Trip	Trips Status
0447	Fixed Boost	Fluxing VHz
0202	Fixed Gateway Address	Option Ethernet
0200	Fixed IP Address	Option Ethernet
0201	Fixed Subnet Mask	Option Ethernet
0318	Flying Reflux Time	Flycatching
0312	Flying Start Mode	Flycatching
0113	Force Fan On	Fan Control
0938	Free Packets	Ethernet

Parameter Reference C-267

PNO	Name	Section
1782	Free Sockets	Ethernet
1754	Free Space (kBytes)	Flash File System
1546	Frequency 1	Filter On Torque Dmd
1547	Frequency 2	Filter On Torque Dmd
1538	Full Restore	Clone
0928	Gateway Address	Ethernet
1142	GKP Password	Graphical Keypad
1862	Green LED Force On	Keypad Override
0114	Group IP Address	Base Comms
0407	Heatsink Temperature	Feedbacks
1667	High Input Threshold	SB Encoder Slot 1
1674	High Input Threshold	SB Encoder Slot 2
0940	High Word First	Modbus
0232	High Word First RTU	Modbus RTU
0235	High Word First TCP	Modbus TCP
1406	HV Power On Count	Runtime Statistics
1252	HV SMPS Up Time	Runtime Statistics
0397	id	Feedbacks
1048	IDE Version	App Info
0894	IM Wiring	Induction Motor Data
0353	Inv Time Active	Stack Inv Time
0348	Inv Time Aiming Point	Stack Inv Time
0351	Inv Time Down Rate	Stack Inv Time
0349	Inv Time Output	Stack Inv Time
0350	Inv Time Up Rate	Stack Inv Time
0352	Inv Time Warning	Stack Inv Time
0996	IO Option FE State	Device State
1125	IO Option Pcode	Drive info
1134	IO Option Serial No	Drive info
1254	IO Option SW Version	Drive info
0926	IP Address	Ethernet
0207	IPConfig Enable	Option Ethernet
0398	iq	Feedbacks
0502	Jog Acceleration Time	Ramp
0503	Jog Deceleration Time	Ramp
0501	Jog Setpoint	Ramp
1866	Key Press	Keypad Override
0994	Keypad FE State	Device State
1005	Language	Setup Wizard
0931	Last Auto IP Address	Ethernet
1047	Last Modification	App Info
0570	Leakage Inductance	Induction Motor Data
1840	Limit Log File Size	Data Logger
0591	Local	Sequencing
1255	Local Dir Key Active	Local Control
1728	Local Port	Peer to Peer
1565	Local Power Up Mode	Sequencing
0592	Local Reference	Sequencing
1240	Local Reverse	Local Control
1239	Local Run Key Active	Local Control
1253	Local/Rem Key Active	Local Control
0936	Lock	Ethernet
1835	Log Enable	Data Logger
1837	Log File Name	Data Logger
1841	Log File Size	Data Logger
1839	Log New File On Reset	Data Logger

PNO	Name	Section
1868	Log Now	Data Logger
1842	Log Parameters	Data Logger
1843	Log Parameters[x]	Data Logger
1836	Log Period	Data Logger
1838	Log to New File	Data Logger
0344	Long Overload Level	Stack Inv Time
0345	Long Overload Time	Stack Inv Time
0920	MAC Address	Ethernet
0568	Magnetising Current	Induction Motor Data
0417	Main Torque Lim	Torque Limit
0891	Maintenance Reporting	Maintenance Monitor
0892	Maintenance Reset	Maintenance Monitor
0890	Maintenance Warnings	Maintenance Monitor
1636	Manufacturing Flags	Drive info
1632	Mapping Valid	Modbus
1751	Master Encoder	Configure
1745	Master Position Src	Configure
1527	Max Available Volts	Tr Adaptation
1859	Max Phase	PMAC Motor Advanced
1459	Max Spd when Autotuned	Autotune
1265	Max Speed Clamp	Speed Ref
0913	Max VDC Ripple	VDC Ripple
0939	Maximum Connections	Modbus
1229	Mechanical Offset	SB Encoder
0317	Min Search Speed	Flycatching
1264	Min Speed Clamp	Speed Ref
1458	Modbus Conn Timeout	Modbus
0229	Modbus Device Address	Modbus RTU
1567	Modbus Mapping	Modbus
1568	Modbus Mapping[x]	Modbus
1640	Modbus Password	Modbus RTU
0230	Modbus RTU Baud Rate	Modbus RTU
0228	Modbus RTU State	Modbus RTU
0233	Modbus RTU Timeout	Modbus RTU
1659	Modbus TCP Password	Modbus
0234	Modbus TCP State	Modbus TCP
0236	Modbus TCP Timeout	Modbus TCP
0941	Modbus Timeout	Modbus
0942	Modbus Trip Enable	Modbus
1270	Monitor	Soft Menus
1271	Monitor[x]	Soft Menus
0340	Mot I2T Active	Motor Load
0342	Mot I2T Enable	Motor Load
0338	Mot I2T TC	Motor Load
0341	Mot I2T Warning	Motor Load
0336	Mot Inv Time Active	Motor Load
0334	Mot Inv Time Delay	Motor Load
0337	Mot Inv Time Output %	Motor Load
0333	Mot Inv Time Overload	Motor Load
0335	Mot Inv Time Warning	Motor Load
0374	Motor Base Volts	Voltage Control
1898	Motor Count	SB Encoder
1894	Motor Count Reset	SB Encoder
0402	Motor Current	Feedbacks
0401	Motor Current Percent	Feedbacks
0458	Motor Poles	Motor Nameplate

PNO	Name	Section
1230	Motor Position	SB Encoder
0460	Motor Power	Motor Nameplate
1407	Motor Run Time	Runtime Statistics
1732	Motor Start Count	Runtime Statistics
0405	Motor Terminal Volts	Feedbacks
0511	Motor Type or AFE	Control Mode
0289	MRAS Field Frequency	MRAS
0286	MRAS Speed Percent	MRAS
0287	MRAS Speed RPM	MRAS
0291	MRAS Torque	MRAS
0290	MRAS Torque Percent	MRAS
0572	Mutual Inductance	Induction Motor Data
1550	Nameplate Mag Current	Autotune
0459	Nameplate Speed	Motor Nameplate
0416	Negative Torque Lim	Torque Limit
0976	Nominal Supply	Drive info
1256	OEM ID	Drive info
1241	Open Connections	Modbus
0198	Option DHCP Enabled	Option Ethernet
0206	Option FTP Admin Mode	Option Ethernet
0205	Option FTP Enable	Option Ethernet
0197	Option Gateway	Option Ethernet
1180	Option IO Diagnostic	Option IO
1179	Option IO Fitted	Option IO
1178	Option IO Required	Option IO
0195	Option IP Address	Option Ethernet
0189	Option MAC Address	Option Ethernet
0196	Option Subnet Mask	Option Ethernet
0203	Option Web Enable	Option Ethernet
1540	Other Parameters	Clone
1756	Output A	SB Retransmit
1291	Output A Invert	SB Retransmit
1757	Output B	SB Retransmit
1292	Output B Invert	SB Retransmit
1678	Output Enable	SB Retransmit
1679	Output Source	SB Retransmit
1680	Output Voltage	SB Retransmit
1758	Output Z	SB Retransmit
1293	Output Z Invert	SB Retransmit
0231	Parity And Stop Bits	Modbus RTU
1097	Password in Favourite	Graphical Keypad
1098	Password in Local	Graphical Keypad
1725	Peer to Peer Enable	Peer to Peer
1729	Peer to Peer State	Peer to Peer
1858	Phase at Rated Current	PMAC Motor Advanced
0560	PMAC Back Emf Const KE	PMAC Motor Data
1387	PMAC Base Volt	PMAC Motor Data
1808	PMAC Encoder Offset	PMAC Motor Data
0693	PMAC Fly Active	PMAC Flycatching
0692	PMAC Fly Load Level	PMAC Flycatching
0690	PMAC Fly Search Mode	PMAC Flycatching
0691	PMAC Fly Search Time	PMAC Flycatching
0694	PMAC Fly Setpoint	PMAC Flycatching
0689	PMAC Flycatching Enable	PMAC Flycatching
0556	PMAC Max Current	PMAC Motor Data
0555	PMAC Max Speed	PMAC Motor Data

C-268 Parameter Reference

PNO	Name	Section
0564	PMAC Motor Inertia	PMAC Motor Data
0559	PMAC Motor Poles	PMAC Motor Data
0557	PMAC Rated Current	PMAC Motor Data
0558	PMAC Rated Torque	PMAC Motor Data
0467	PMAC SVC Auto Values	PMAC SVC
0470	PMAC SVC I Gain Hz	PMAC SVC
0468	PMAC SVC LPF Speed Hz	PMAC SVC
0476	PMAC SVC Open Loop Strt	PMAC SVC
0469	PMAC SVC P Gain	PMAC SVC
0478	PMAC SVC Start Cur	PMAC SVC
0479	PMAC SVC Start Speed	PMAC SVC
0477	PMAC SVC Start Time	PMAC SVC
0565	PMAC Therm Time Const	PMAC Motor Data
0563	PMAC Torque Const KT	PMAC Motor Data
0562	PMAC Winding Inductance	PMAC Motor Data
0561	PMAC Winding Resistance	PMAC Motor Data
1809	PMAC Wiring	PMAC Motor Data
0415	Positive Torque Lim	Torque Limit
0461	Power Factor	Motor Nameplate
0386	Power Factor Angle Est	Energy Meter
0385	Power Factor Est	Energy Meter
0381	Power HP	Energy Meter
0380	Power kW	Energy Meter
1541	Power Parameters	Clone
0543	Power Stack Fitted	Drive info
0987	Power Stack Required	Drive info
0943	Process Active	Modbus
1551	Product Code Flags	Drive info
0238	Profibus Node Address	Profibus
0237	Profibus State	Profibus
0240	PROFINET Device Name	PROFINET IO
0239	PROFINET State	PROFINET IO
1054	Project Author	App Info
1068	Project Description	App Info
1040	Project File Name	App Info
1061	Project Version	App Info
1699	PTP Clock	PTP
1683	PTP Clock Mode	PTP
1684	PTP Clock Type	PTP
1787	PTP Domain Number	PTP
1661	PTP Enable	PTP
1685	PTP Lock Threshold	PTP
1688	PTP Locked	PTP
1681	PTP Log Sync Interval	PTP
1687	PTP Offset	PTP
1686	PTP Priority2	PTP
1689	PTP State	PTP
1648	Pwrl Accel Rate	Power Loss Ride Thru
1651	Pwrl Active	Power Loss Ride Thru
1647	Pwrl Control Band	Power Loss Ride Thru
1649	Pwrl Decel Rate	Power Loss Ride Thru
1645	Pwrl Enable	Power Loss Ride Thru
1650	Pwrl Time Limit	Power Loss Ride Thru
1646	Pwrl Trip Threshold	Power Loss Ride Thru
0508	Quickstop Ramp Time	Ramp
0507	Quickstop Time Limit	Ramp

PNO	Name	Section
0497	Ramp Hold	Ramp
0499	Ramp Spd Setpoint Input	Ramp
0500	Ramp Speed Output	Ramp
0485	Ramp Type	Ramp
0498	Ramping Active	Ramp
1682	Random Pattern AFE	Pattern Generator
0413	Random Pattern IM	Pattern Generator
1268	Random Pattern PMAC	Pattern Generator
0455	Rated Motor Current	Motor Nameplate
1247	Ratio Load Mot Inert	Spd Loop Settings
0382	Reactive Power	Energy Meter
0055	Read Mapping	Read Process
0056	Read Mapping[x]	Read Process
1442	Recent Trip Times	Trips History
1443	Recent Trip Times[x]	Trips History
0895	Recent Trips	Trips History
0896	Recent Trips[x]	Trips History
1863	Red LED Force Off	Keypad Override
0682	Reference	Sequencing
0307	Regen Limit Enable	Current Limit
0389	Reset Energy Meter	Energy Meter
1000	Reset to Defaults	Device Commands
1827	Resolver Active Resol	Resolver
1826	Resolver Actual Filter	Resolver
1822	Resolver Built-In Gear	Resolver
1812	Resolver Fraction Turns	Resolver
1791	Resolver Frequency	Resolver
1810	Resolver Invert	Resolver
1825	Resolver Max Speed	Resolver
1851	Resolver Min Filter	Resolver
1793	Resolver Poles	Resolver
1824	Resolver Position	Resolver
1792	Resolver Ratio	Resolver
1819	Resolver Reset Power On	Resolver
1816	Resolver Resolution	Resolver
1814	Resolver Speed %	Resolver
1815	Resolver Speed Filter	Resolver
1821	Resolver Speed Hz	Resolver
1823	Resolver Speed Ripple	Resolver
1813	Resolver Speed RPM	Resolver
1817	Resolver State	Resolver
1820	Resolver Trip Type	Resolver
1811	Resolver Turns	Resolver
1818	Resolver Turns Reset	Resolver
1790	Resolver Voltage	Resolver
1364	Rotor Resistance	Induction Motor Data
0569	Rotor Time Constant	Induction Motor Data
0998	RTA Code	Device State
0999	RTA Data	Device State
1003	RTA Thread Priority	Device State
1187	RTC Trim	General Purpose IO
1140	Run Key Action	Local Control
1006	Run Wizard?	Setup Wizard
1001	Save All Parameters	Device Commands
1374	SB Dig Out 1 Invert	SB Digital IO
1375	SB Dig Out 2 Invert	SB Digital IO

PNO	Name	Section
1376	SB Dig Out 3 Invert	SB Digital IO
1332	SB Digital In 1 Invert	SB Digital IO
1333	SB Digital In 2 Invert	SB Digital IO
1334	SB Digital In 3 Invert	SB Digital IO
1368	SB Digital In 4 Invert	SB Digital IO
1369	SB Digital In 5 Invert	SB Digital IO
1370	SB Digital In 6 Invert	SB Digital IO
1759	SB Digital Input 1	SB Digital IO
1722	SB Digital Input 2	SB Digital IO
1723	SB Digital Input 3	SB Digital IO
1365	SB Digital Input 4	SB Digital IO
1366	SB Digital Input 5	SB Digital IO
1367	SB Digital Input 6	SB Digital IO
1371	SB Digital Output 1	SB Digital IO
1372	SB Digital Output 2	SB Digital IO
1373	SB Digital Output 3	SB Digital IO
1861	Scaled PNO Access	Setup Wizard
0315	Search Boost	Flycatching
0313	Search Mode	Flycatching
0316	Search Time	Flycatching
0314	Search Volts	Flycatching
0527	Sel Torq Ctrl Only	Spd Loop Settings
1867	Selected Parameter	Keypad Override
1257	Seq Stop Method SVC	Ramp
0484	Seq Stop Method VHz	Ramp
0678	Sequencing State	Sequencing
1311	Setup	Soft Menus
1749	Setup Successful	Configure
1312	Setup[x]	Soft Menus
0346	Short Overload Level	Stack Inv Time
0347	Short Overload Time	Stack Inv Time
0115	Show Warnings 1 - 32	Trips Status
0116	Show Warnings 33 - 64	Trips Status
1752	Slave Encoder	Configure
1744	Slave Position Src	Configure
0361	Slew Rate Accel Limit	Slew Rate
0362	Slew Rate Decel Limit	Slew Rate
0360	Slew Rate Enable	Slew Rate
0354	Slip Compensatn Enable	Slip Compensation
0356	SLP Motoring Limit	Slip Compensation
0357	SLP Regen Limit	Slip Compensation
1788	SNTP Client Enable	SNTP Client
1789	SNTP Remote Server	SNTP Client
1891	SNTP Server Enable	SNTP Server
1386	SNTP Status	SNTP Client
1794	Soft Key 2 Mode	Graphical Keypad
1795	Soft Key 2 Value	Graphical Keypad
0526	Spd Demand Neg Lim	Spd Loop Settings
0525	Spd Demand Pos Lim	Spd Loop Settings
1780	Spd Limiter Torq Ctrl	Spd Loop Settings
0524	Spd Loop Adapt Pgain	Spd Loop Settings
0523	Spd Loop Adapt Thres	Spd Loop Settings
0521	Spd Loop Aux Torq Dmd	Spd Loop Settings
0519	Spd Loop Dmd Filt TC	Spd Loop Settings
1753	Spd Loop Encoder	Configure
0520	Spd Loop Fbk Filt TC	Spd Loop Settings

Parameter Reference C-269

PNO	Name	Section
0466	Speed Demand Hz	Scale Setpoint
0465	Speed Demand RPM	Scale Setpoint
1747	Speed Error Threshold	Speed Error Trip
1748	Speed Error Trip Delay	Speed Error Trip
1746	Speed Error Trip Enable	Speed Error Trip
1781	Speed Limiter Active	Spd Loop Diagnostics
1246	Speed Loop Auto Set	Spd Loop Settings
1248	Speed Loop Bandwidth	Spd Loop Settings
0535	Speed Loop Error	Spd Loop Diagnostics
0516	Speed Loop I Time	Spd Loop Settings
0517	Speed Loop Int Defeat	Spd Loop Settings
0518	Speed Loop Int Preset	Spd Loop Settings
0515	Speed Loop Pgain	Spd Loop Settings
0536	Speed PI Output	Spd Loop Diagnostics
1266	Speed Trim	Speed Ref
0491	Stramp Acceleration	Ramp
0490	Stramp Continuous	Ramp
0492	Stramp Deceleration	Ramp
0493	Stramp Jerk 1	Ramp
0494	Stramp Jerk 2	Ramp
0495	Stramp Jerk 3	Ramp
0496	Stramp Jerk 4	Ramp
0364	Stabilisation Enable	Stabilisation
0404	Stack Current (%)	Feedbacks
0412	Stack Frequency	Pattern Generator
1109	Stack Pcode	Drive info
1258	Stack Serial No	Drive info
0910	Stall Current Active	Stall Trip
0906	Stall Limit Type	Stall Trip
0911	Stall Speed Feedback	Stall Trip
0907	Stall Time	Stall Trip
0909	Stall Torque Active	Stall Trip
1887	Start Align Done	Control Mode
1634	Start Delay	Motor Sequencer
1560	Start Delay Enable	Motor Sequencer
1885	Startup Alignment	Control Mode
0982	Startup Page	Graphical Keypad
0571	Stator Resistance	Induction Motor Data
0661	Status Word	Sequencing
0504	Stop Ramp Time	Ramp

PNO	Name	Section
0927	Subnet Mask	Ethernet
0679	Switch On Timeout	Sequencing
1701	Switchover Enable	MRAS
0488	Symmetric Mode	Ramp
0489	Symmetric Time	Ramp
0419	Symmetric Torque Lim	Torque Limit
1871	Synth Encoder Count	SB Retransmit
1702	Synth Encoder Invert	SB Retransmit
1696	Synth Encoder Lines	SB Retransmit
1698	Synth Encoder Speed	SB Retransmit
1742	System Board FE State	Device State
1740	System Board Fitted	System Board Option
1739	System Board Required	System Board Option
1741	System Board Status	System Board Option
0988	Target State	Device State
1099	Technician Password	Graphical Keypad
0371	Terminal Voltage Mode	Voltage Control
1529	Terminal Volts	Tr Adaptation
1185	Thermistor Resistance	Thermistor
1004	Thermistor Trip Level	Thermistor
1184	Thermistor Type	Thermistor
1762	Thermistor Warn Delta	Thermistor
1186	Time and Date	Real Time Clock
1733	Time Since Power-On	Runtime Statistics
1228	Time Zone Offset	Real Time Clock
0534	Total Spd Demand %	Spd Loop Diagnostics
0533	Total Spd Demand RPM	Spd Loop Diagnostics
1521	Tr Adaptation Output	Tr Adaptation
1267	Trim in Local	Speed Ref
1002	Update Firmware	Device Commands
1854	Update GKP Text	Graphical Keypad
0935	User Gateway Address	Ethernet
0933	User IP Address	Ethernet
0934	User Subnet Mask	Ethernet
0311	VC Flying Start Enable	Flycatching
1643	VDC Lim Active	DC Link Volts Limit
1641	VDC Lim Enable	DC Link Volts Limit
1642	VDC Lim Level	DC Link Volts Limit
1644	VDC Lim Output	DC Link Volts Limit
0912	VDC Ripple Filter TC	VDC Ripple

PNO	Name	Section
0917	VDC Ripple Level	VDC Ripple
0916	VDC Ripple Sample	VDC Ripple
0914	VDC Ripple Trip Delay	VDC Ripple
0915	VDC Ripple Trip Hyst	VDC Ripple
1143	Version	Graphical Keypad
0310	VHz Flying Start Enable	Flycatching
0422	VHz Shape	Fluxing VHz
0423	VHz User Freq	Fluxing VHz
0424	VHz User Freq[x]	Fluxing VHz
0435	VHz User Volts	Fluxing VHz
0436	VHz User Volts[x]	Fluxing VHz
1141	View Level	Graphical Keypad
0453	Vsd Demand	Fluxing VHz
0454	Vsq Demand	Fluxing VHz
0829	Warnings 1 - 32	Trips Status
0514	Warnings 33 - 64	Trips Status
0972	Warranty Trip Time	Trips History
0973	Warranty Trip Time[x]	Trips History
0968	Warranty Trips	Trips History
1408	Warranty Trips Record	Trips History
0969	Warranty Trips[x]	Trips History
0944	Web Access	Web Server
0204	Web Parameters Enable	Option Ethernet
0946	Web Password	Web Server
0945	Web View Level	Web Server
0120	Write Mapping	Write Process
0121	Write Mapping[x]	Write Process
1870	Z Pulse	SB Retransmit
1872	Z Pulse Init Done	SB Retransmit
0506	Zero Speed Stop Delay	Ramp
0505	Zero Speed Threshold	Ramp

C-270 Parameter Reference

Power Dependent Parameter Defaults

The tables below shows the parameters whose default value is dependent on the Power Stack.

Parameter		PNO	NONE	3.5 A 400 V	4.5 A 400 V	5.5 A 400 V	7.5 A 400 V	10.0 A 400 V	12.0 A 400 V	16.0 A 400 V	23.0 A 400 V	32.0 A 400 V	38.0 A 400 V	45.0 A 400 V r3	45.0 A 400 V R1 45.0 A 400 V
Brake Resistance	Ohm	251	100	100	100	100	100	100	100	52	52	26	26	17	17
Brake Rated Power	kW	252	0.11	0.11	0.15	0.22	0.3	0.4	0.55	0.75	1.1	1.5	1.8	2.2	2.2
Autotune Ramp Time		274	10	10	10	10	10	10	10	10	10	10	10	10	10
mras coupling kc		278	14.9874	14.9874	11.5288	6.2448	2.9363	1.7128	2.6526	2.6526	1.314	0.9592	0.7105	0.7105	0.7105
mras adaptive kc		280	4.3851	4.3851	2.6283	1.5279	0.7514	0.5727	0.6854	0.6854	0.3198	0.3484	0.1792	0.1792	0.1792
mras adaptive td	s	282	0.1094	0.1094	0.1094	0.1367	0.1367	0.1367	0.276	0.276	0.3036	0.3795	0.506	0.506	0.506
mras ls low threshold	Hz	294	1.50	1.50	1.50	1.50	1.50	1.50	1.50	1.50	1.50	1.50	1.50	1.50	1.50
mras ls high threshold	Hz	295	2.50	2.50	2.50	2.50	2.50	2.50	2.50	2.50	2.50	2.50	2.50	2.50	2.50
mras adaptive loop bwdt	Hz	300	4	4	4	4	4	4	4	3	3	2	2	2	2
i lim vhz p gain		308	2	2	2	2	2	2	2	2	2	2	2	2	2
i lim vhz l gain		309	0.5	0.5	0.5	0.5	0.5	0.5	0.5	0.5	0.5	0.3	0.3	0.3	0.3
Search Volts	%	314	9	9	9	9	9	9	9	9	9	9	9	10	10
Search Boost	%	315	40	40	40	40	40	40	40	40	40	15	15	15	15
Search Time		316	5	5	5	5	5	5	5	10	10	15	15	25	25
Flying Reflux Time		318	3	3	3	3	3	3	3	3	3	4	4	5	5
error scaler	%	322	200	200	200	200	200	200	200	200	200	175	175	150	150
DC Inj Deflux Time		324	0.5	0.5	0.5	0.5	0.5	0.5	0.5	0.5	0.5	1	1	1.5	1.5
DC Inj Frequency	Hz	325	9	9	9	9	9	9	9	9	9	9	9	6	6
DC Pulse Time		327	2	2	2	2	2	2	2	2	2	2	2	2	2
Final DC Pulse Time		328	1	1	1	1	1	1	1	1	1	3	3	3	3
DC Current Level	%	329	3	3	3	3	3	3	3	2.5	2.5	1.75	1.75	1.25	1.25
DC Inj Base Volts	%	331	100	100	100	100	100	100	100	100	100	100	100	75	75
stb trim limit	Hz	368	1	1	1	1	1	1	1	1	1	0.75	0.75	0.5	0.5
Stack Frequency	kHz	412	4	4	4	4	4	4	4	4	4	4	4	3	3
Deflux Delay		414	1.0	1.0	1.0	1.0	1.0	1.0	1.0	1.0	1.0	1.0	1.0	2.0	2.0
auto boost tc		449	0.25	0.25	0.25	0.25	0.25	0.25	0.25	0.25	0.25	0.3	0.3	0.3	0.3
Rated Motor Current	A	455	1.56	1.56	2.88	4.9	6.5	8.4	9.04	14.6	20	27	26.4	38	38
Motor Power	kW	460	0.75	0.75	1.1	1.5	2.2	3	4	5.5	7.5	11	15	18	18
Power Factor		461	0.71	0.71	0.7	0.78	0.8	0.8	0.8	0.83	0.86	0.87	0.88	0.88	0.88
Acceleration Time		486	10	10	10	10	10	10	10	10	10	10	10	20	20
Deceleration Time		487	10	10	10	10	10	10	10	10	10	10	10	20	20
Symmetric Time		489	10	10	10	10	10	10	10	10	10	10	10	20	20
total inertia	kgm ²	590	0.0014	0.0014	0.0014	0.0035	0.050	0.0112	0.0176	0.0176	0.0236	0.0603	0.0754	0.0754	0.0754
Stall Time		907	90	90	90	90	90	90	90	90	90	90	90	90	90
Max VDC Ripple	V	913	50	50	50	70	70	80	80	85	85	80	80	95	80
VDC Ripple Trip Delay		914	60	60	60	60	60	60	60	60	60	60	60	30	30
frame size		986	4	4	4	4	4	4	4	5	5	6	6	6	7
Nameplate Mag Current	A	1550	0.88	0.88	1.65	2.45	3.12	4.03	4.34	6.51	8.16	10.65	10.03	14.44	14.44

Parameter Reference C-271

Parameter		PNO	60.0 A 400 V R1 60.0 A 400 V	73.0 A 400 V R1 73.0 A 400 V	87.0 A 400 V	105 A 400 V	145 A 400 V	180 A 400 V	205 A 400 V	260 A 400 V	315 A 400 V	380 A 400 V	440 A 400 V
Brake Resistance	Ohm	251	17	17	8	8	8	4	4	4	0.75	0.75	0.75
Brake Rated Power	kW	252	3.0	3.7	4.5	5.5	7.5	9	11	13.2	1.25	1.25	1.25
Autotune Ramp Time		274	10	10	10	10	10	20	20	20	2	2	2
mras coupling kc		278	0.5048	0.3553	0.2907	0.2428	0.1798	0.1453	0.127	0.1043	1	1	1
mras adaptive kc		280	0.305	0.2823	0.2974	0.2472	0.2226	0.1427	0.1343	0.1228	0.2	0.2	0.2
mras adaptive td	s	282	0.3795	0.506	0.506	0.506	0.6073	0.6073	0.7591	1.5182	10	10	10
mras ls low threshold	Hz	294	1.50	1.50	1.50	1.50	1.50	1.50	1.50	1.50	10	10	10
mras ls high threshold	Hz	295	2.50	2.50	2.50	2.50	2.50	2.50	2.50	2.50	45	45	45
mras adaptive loop bwdt	Hz	300	2	2	2	2	2	2	2	2	6	6	6
i lim vhz p gain		308	2	2	2	2	2	2	2	2	150	150	150
i lim vhz i gain		309	0.3	0.3	0.3	0.3	0.3	0.2	0.2	0.2	3	3	3
Search Volts	%	314	10	10	10	10	10	10	10	10	4	4	4
Search Boost	%	315	15	15	15	15	15	10	10	10	3	3	3
Search Time		316	25	25	30	30	30	40	40	40	5	5	5
Flying Reflux Time		318	5	5	6	6	6	6	6	6	1	1	1
error scaler	%	322	150	150	150	150	150	150	150	150	50	50	50
DC Inj Deflux Time		324	1.5	1.5	3	3	3	3	3	3	0.5	0.5	0.5
DC Inj Frequency	Hz	325	6	6	6	6	6	4	4	4	2	2	2
DC Pulse Time		327	2	2	2	2	2	3	3	3	6.0	8.0	8.0
Final DC Pulse Time		328	3	3	3	3	3	5	5	5	0.5	0.5	0.5
DC Current Level	%	329	1.25	1.25	1.25	1.25	1.25	1	1	1	287	346	401
DC Inj Base Volts	%	331	75	75	75	75	75	50	50	50	132	160	200
stb trim limit	Hz	368	0.5	0.5	0.5	0.5	0.5	0.5	0.5	0.5	0.91	0.92	0.93
Stack Frequency	kHz	412	3	3	2.5	2.5	2.5	2.5	2.5	2.5	50	50	50
Deflux Delay		414	2.0	2.0	3.0	3.0	3.0	3.5	3.5	3.5	50	50	50
auto boost tc		449	0.3	0.3	0.3	0.3	0.3	0.5	0.5	0.5	50	50	50
Rated Motor Current	A	455	54	66	79	97	132	164	186	236	5.5	6.2	7
Motor Power	kW	460	22	30	37	45	55	75	90	110	60	60	60
Power Factor		461	0.86	0.85	0.87	0.86	0.87	0.87	0.9	0.9	65	80	65
Acceleration Time		486	20	20	30	30	30	50	50	50	30	30	30
Deceleration Time		487	20	20	30	30	30	50	50	50	10	10	10
Symmetric Time		489	20	20	30	30	30	50	50	50	110	131	152
total inertia	kgm ²	590	0.1906	0.4750	0.7476	0.8904	1.4500	1.722	2.65	3.6	0.75	0.75	0.75
Stall Time		907	90	90	90	90	90	60	60	60	1.25	1.25	1.25
Max VDC Ripple	V	913	80	80	80	80	80	80	80	80	2	2	2
VDC Ripple Trip Delay		914	30	30	30	30	30	30	30	30	1	1	1
frame size		986	7	7	8	8	8	9	9	9	0.2	0.2	0.2
Nameplate Mag Current	A	1550	22.04	27.81	31.16	39.60	52.07	64	74	93	10	10	10

C-272 Parameter Reference

Parameter		PNO	530 A 400 V	590 A 400 V	650 A 400 V	700 A 400 V	790 A 400 V
Brake Resistance	Ohm	251	0.75	0.75	0.75	0.75	0.75
Brake Rated Power	kW	252	1.25	1.25	1.25	1.25	1.25
Autotune Ramp Time		274	2	2	2	2	2
mras coupling kc		278	1	1	1	1	1
mras adaptive kc		280	0.2	0.2	0.2	0.2	0.2
mras adaptive td	s	282	10	10	10	10	10
mras ls low threshold	Hz	294	10	10	10	10	10
mras ls high threshold	Hz	295	45	45	45	45	45
mras adaptive loop bwtd	Hz	300	6	6	6	6	7
i lim vhz p gain		308	150	150	150	150	125
i lim vhz i gain		309	3	3	3	3	4
Search Volts	%	314	4	4	4	4	3
Search Boost	%	315	3	3	3	3	4
Search Time		316	5	5	5	5	7
Flying Reflux Time		318	1	1	1	1	1
error scaler	%	322	50	50	50	50	50
DC Inj Deflux Time		324	0.5	0.5	0.5	0.5	0.35
DC Inj Frequency	Hz	325	2	2	2	2	2
DC Pulse Time		327	10.0	10.0	12.0	12.0	12.0
Final DC Pulse Time		328	0.5	0.5	0.5	0.5	0.5
DC Current Level	%	329	489	535	597	661	783
DC Inj Base Volts	%	331	250	280	315	355	400
stb trim limit	Hz	368	0.93	0.93	0.93	0.93	0.94
Stack Frequency	kHz	412	50	50	50	50	50
Deflux Delay		414	50	50	50	50	50
auto boost tc		449	50	50	50	50	50
Rated Motor Current	A	455	9.5	10	11	12.9	13.7
Motor Power	kW	460	60	60	60	60	60
Power Factor		461	70	70	70	70	75
Acceleration Time		486	30	30	30	30	30
Deceleration Time		487	11	11	12	12	13
Symmetric Time		489	185	203	227	251	298
total inertia	kgm ²	590	0.75	0.75	0.75	0.75	0.75
Stall Time		907	1.25	1.25	1.25	1.25	1.25
Max VDC Ripple	V	913	2	2	2	2	2
VDC Ripple Trip Delay		914	1	1	1	1	1
frame size		986	0.2	0.2	0.2	0.2	0.2
Nameplate Mag Current	A	1550	10	10	10	10	10

Appendix D: AC30 Series Product Codes

Understanding the Product Code

The unit is fully identified using an alphanumeric code. This records how the inverter was calibrated, and its various settings when dispatched from the factory. This can also be referred to as the Product Code.

AC30 SERIES CONTROL MODULE

	1	2		3	4		5
Order example	30	V	-	2	S	-	0000
1	Device Family						
	30	AC30 series control module only (no power stack)					
2	Industry						
	V	Standard controller					
	P	Advanced controller					
	D	Advanced controller with dual encoder system option					
	A	Advanced controller with absolute encoder system option					
3	Graphical Keypad						
	1	Blanking cover fitted					
	2	Graphical keypad fitted					
4	Environmental Coating						
	S	Standard 3C3 coating					
5	Special Options						
	0000	No special options					

Typical example: 30V-2S-0000 (as shown in the “Order example” above).

This shows the product is an AC30 series versatile controller, with Graphical Keypad fitted, standard 3C3 conformal coating and no special options.

Note: This product code is for the control module only. The power stack must be ordered in addition to this (see page D-2).

D-2 AC30 Series Product Codes

AC30 SERIES POWER STACK

	1		2	3		4	5		6	7		8	
Order example	710	-	4	D	0004	-	B	E	-	0	S	-	0000

1	Device Family
710	AC Power stack only (no control module)
740	DC Power stack only (no control module)
2	Voltage
4	400 V nominal supply system (AC line)
3	Frame Size and Current Rating
	(normal / heavy duty)
D0004	1.1 kW / 0.75 kW
D0006	2.2 kW / 1.5 kW
D0010	4 kW / 3 kW
D0012	5.5 kW / 4 kW
E0016	7.5 kW / 5.5 kW
E0023	11 kW / 7.5 kW
F0032	15 kW / 11 kW
F0038	18.5 kW / 15 kW
F0045	22 kW / 18.5 kW
G0045	22 kW / 18.5 kW
G0060	30 kW / 22 kW
G0073	37 kW / 30 kW
H0087	45 kW / 37 kW
H0105	55 kW / 45 kW
H0145	75 kW / 55 kW
J0180	90 kW / 75 kW
J0205	110 kW / 90 kW
J0260	132 kW / 110 kW

3	Frame Size and Current Rating (cont'd)
	(normal / heavy duty)
K0315	160 kW / 132 kW
K0380	200 kW / 160 kW
K0440	250 kW / 200 kW
L0530	280 kW / 250 kW
L0590	315 kW / 280 kW
M0650	355 kW / 315 kW
M0700	400 kW / 355 kW
N0790	450 kW / 400 kW
4	Brake Switch
N	Without brake switch (Frames LMN only)
B	Brake switch fitted (Frames D-K only)
5	EMC Filter ⁽¹⁾
N	No filter fitted
E	Category C3 filter fitted (standard)
F	Category C2 filter fitted (Frames D-H only)
6	Graphical Keypad
0	No keypad fitted
7	Environmental Coating
S	Standard 3C3 coating
8	Special Options
0000	No special options

(1) 1. Only EMC filter option N is valid on 740 products.

2. Only EMC filter option E is valid on Frame sizes K, L, M & N 710 products.

Typical example: 710-4D0004-BE-0S-0000 (as shown in the "Order example" above).

This shows the product is an AC30 series AC line fed Frame D power stack, IP21 standard, rated at 400-480 volts supply, 1.1kW (normal duty), with brake switch fitted, Category C3 EMC filter, no Graphical Keypad fitted, standard 3C3 conformal coating and no special options.

Note: This product code is for the power stack only. The control module must be ordered in addition to this (see page D-1).

CONFIGURED AC30 SERIES INVERTER

Note: Not all configurable order codes are available in all territories.

Order example	1	2		3	4		5	6		7	8		9	
	31	V	-	4	D	0004	-	B	E	-	2	S	-	0000

1	Device Family
31	AC30 series complete AC line fed drive
34	AC30 series complete DC link fed drive
2	Industry
V	Standard controller
P	Advanced controller
D	Advanced controller with dual encoder system option
A	Advanced controller with absolute encoder system option
3	Voltage
4	400 V nominal supply system (AC line)
4	Frame Size and Current Rating
	(normal / heavy duty)
D0004	1.1 kW / 0.75 kW
D0006	2.2 kW / 1.5 kW
D0010	4 kW / 3 kW
D0012	5.5 kW / 4 kW
E0016	7.5 kW / 5.5 kW
E0023	11 kW / 7.5 kW
F0032	15 kW / 11 kW
F0038	18.5 kW / 15 kW
F0045	22 kW / 18.5 kW
G0045	22 kW / 18.5 kW
G0060	30 kW / 22 kW
G0073	37 kW / 30 kW
H0087	45 kW / 37 kW
H0105	55 kW / 45 kW
H0145	75 kW / 55 kW

4	Frame Size and Current Rating (cont'd)
	(normal / heavy duty)
J0180	90 kW / 75 kW
J0205	110 kW / 90 kW
J0260	132 kW / 110 kW
K0315	160 kW / 132 kW
K0380	200 kW / 160 kW
K0440	250 kW / 200 kW
L0530	280 kW / 250 kW
L0590	315 kW / 280 kW
M0650	355 kW / 315 kW
M0700	400 kW / 355 kW
N0790	450 kW / 400 kW
5	Brake Switch
N	Without brake switch (Frames LMN only)
B	Brake switch fitted (Frames D-K only)
6	EMC Filter ⁽¹⁾
N	No filter fitted
E	Category C3 filter fitted (standard)
F	Category C2 filter fitted (Frames D-H only)
7	Graphical Keypad
1	Blanking cover fitted
2	Graphical keypad fitted
8	Environmental Coating
S	Standard 3C3 coating
9	Special Options
0000	No special options

(1) 1. Only EMC filter option N is valid on 740 products.

2. Only EMC filter option E is valid on Frame sizes K, L, M & N 710 products.

Typical example: 31V-4D004-BE-2S-0000 (as shown in the "Order example" above).

This shows the product is an AC30 series AC line fed Frame D inverter with versatile controller, IP21 standard, rated at 400-480 volts supply, 1.1kW (normal duty), with brake switch fitted, Category C3 EMC filter, with Graphical Keypad fitted, standard 3C3 conformal coating and no special options.

Note: This product code is for a complete AC30V series drive (includes both control module and power stack).

D-4 AC30 Series Product Codes

AC30 SERIES REGENERATIVE SUPPLY UNIT

	1		2	3		4	5		6	
Order example	380	-	5	R	0094	-	N	E	-	0000

1	Device Family
380	AC30 series regenerative supply unit
2	Voltage
5	400 V - 500 V nominal
3	Frame Size and Current Rating
	Output drive current rating / Nominal driving power @ 500V
R0094	94 A/60 kW
R0157	157 A/100 kW
S0251	251 A/160 kW
S0394	394 A/250 kW
S0536	536 A/340 kW

4	Brake Switch
N	Without brake switch (standard)
5	EMC Filter
E	Category C3 compliant (standard)
6	Special Options
0000	No special options

Typical example: 380-5R0094-NE-0000 (as shown in the "Order example" above).

This shows the product is an AC30 series regenerative supply unit, rated at 400-500 volts supply, 94A output current rating – 60kW @ 500V, without a brake switch fitted, Category C3 compliant and no special options.

Appendix E: Library Function Blocks

Introduction

The AC30 drive is a highly flexible and configurable unit. While the functionality that is standard in the drive's firmware is often adequate, this can be extended by writing additional code in the IEC6-1131-3 application. This appendix describes blocks that are made available as part of the AC30 libraries.

These blocks can also be seen and selected in the list of blocks, typically visible to the right of the block diagram in PDQ and PDD, as shown below.

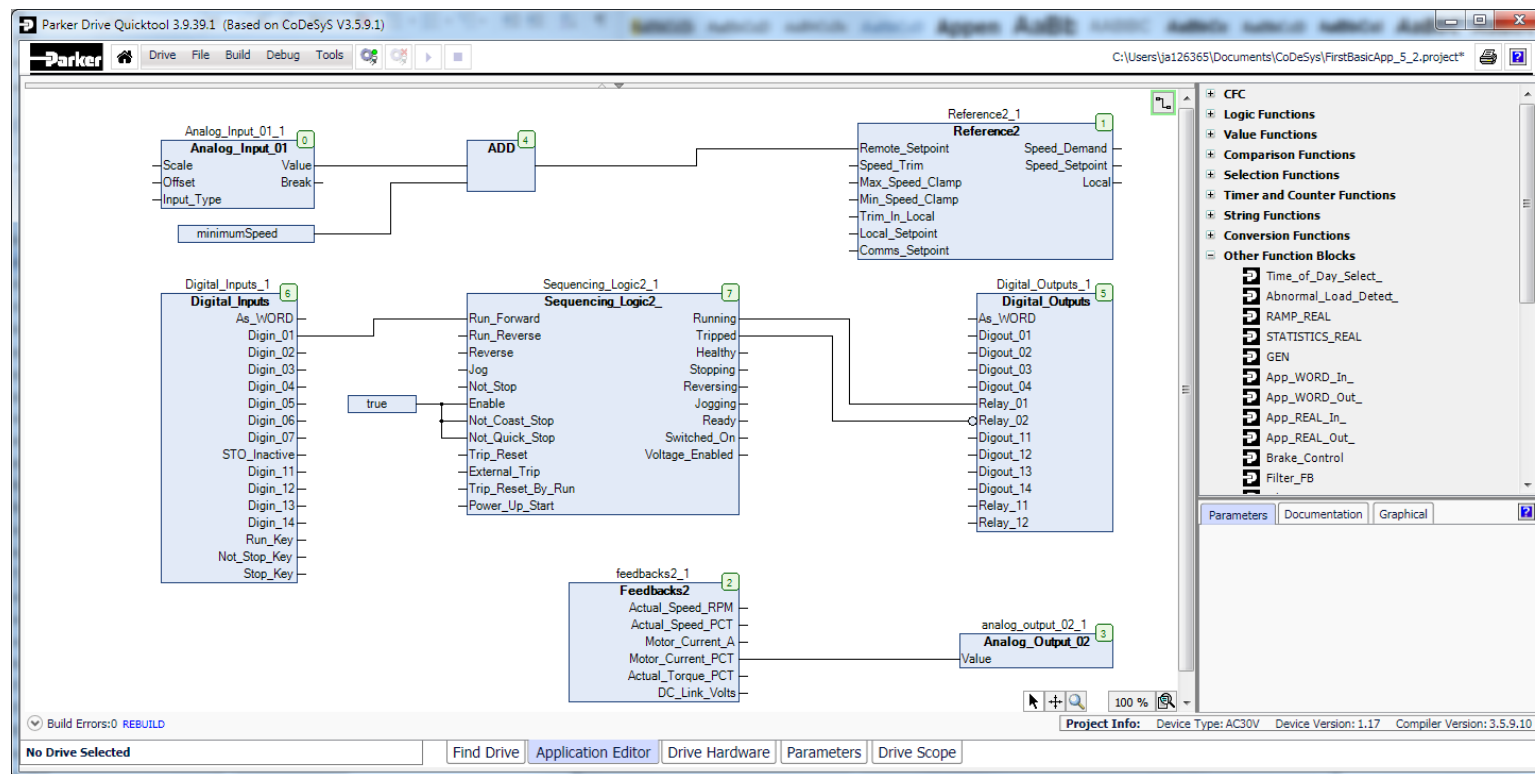

Other blocks shown in this area in PDQ represent collections of drive parameters. These parameters are described in Appendix C.

E-2 Library Function Blocks

Function Block List

BLOCKS IN "AC30 STANDARD" LIBRARY

Abnormal Load Detect	E-3	Linear Fit	E-17	Queue Parameter Write	E-30
Application Alert	E-6	Linear Fit 2	E-18	Raise Lower	E-32
Application Trips	E-7	Linear Ramp	E-20	Read Data From SD Card	E-33
Application Trips Text	E-8	Minimum Speed2	E-22	Sequencing Logic2	E-34
Brake Control	E-9	NTC Thermistor Converter	E-23	Skip Frequencies	E-36
Data Logger Int	E-11	NTC Trip Levels	E-24	Speed Sensor Fault Ride Through	E-38
Data Logger Real	E-11	PID	E-25	S Ramp	E-39
Filter	E-13	Position	E-27	Time Of Day Select	E-41
Filter 2	E-13	Presets2	E-28	Welcome Screen	E-43
Fire Mode	E-14	PT1000 Converter	E-29	Write Data to SD Card	E-44
Home	E-15	PT1000 Trip Levels	E-29	Write Data to SD Card V2	E-44
KTY 84 130 Converter	E-16	Queued Write Control	E-30	Zero Speed	E-45

Function Block Descriptions

ABNORMAL LOAD DETECT

The Abnormal Load Detect function block can be used to detect a sudden change in the behavior of the load. One use of this feature is described in the Pump Application manuals HA502134U001 and HA502134U005.

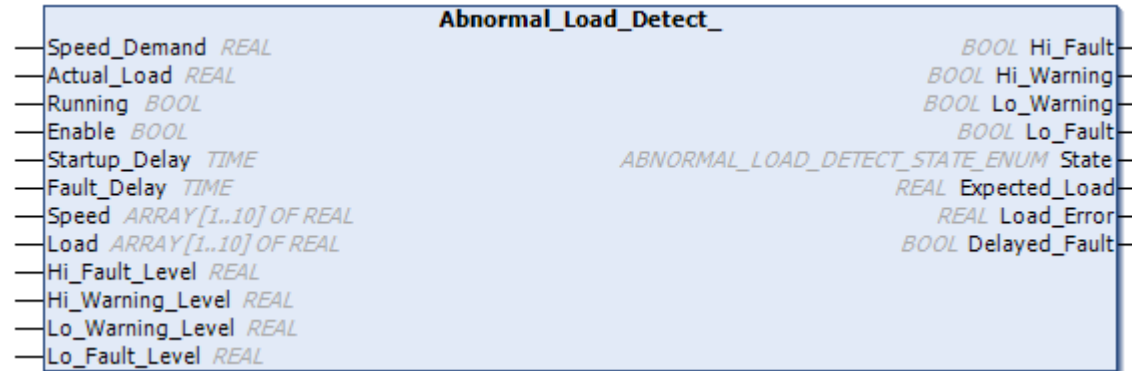

Parameters

Variable	Description
Speed_Demand	The demanded speed in percent. Typically connected to parameter PNO 0500 Ramp Speed Output
Actual_Load	The measured or estimated load in percent. Typically connected to PNO 399 Actual Torque
Running	Set TRUE to indicate that the drive is running. Typically connected to the Running output from Sequencing_Logic2.
Enable	Set TRUE to enable the feature
Startup_Delay	The duration from when the motor is started until the load monitoring is started. This allows for inaccurate speed/load characterization and load estimation during start-up period.
Fault_Delay	The duration from when the load monitor detects a LOAD FAULT until the sequencer stops the motor. This allows for inaccurate speed/load characterization and load estimation during start-up period.
Speed	These 10 parameters together with the 10 Load parameters below are used to characterize the expected load curve for the actual Speed
Load	See above, Speed .
Hi_Fault_Level	The deviation of the actual load above the expected load which will cause a LOAD HIGH FAULT to be reported.
Hi_Warning_Level	The deviation of the actual load above the expected load which will cause a LOAD HIGH WARNING to be reported.
Lo_Warning_Level	The deviation of the actual load below the expected load which will cause a LOAD LOW WARNING to be reported.

E-4 Library Function Blocks

Variable	Description
Lo_Fault_Level	The deviation of the actual load below the expected load which will cause a LOAD LOW FAULT to be reported.
Hi_Fault	The actual Load is above Hi_Fault_Level .
Hi_Warning	The actual Load is above Hi_Warning_Level .
Lo_Warning	The actual Load is below Lo_Warning_Level .
Lo_Fault	The actual Load is below Lo_Fault_Level .
State	<p>Reports whether the monitor is monitoring and, if so, if the Load is as expected. This is an enumerated value:</p> <ul style="list-style-type: none"> 0 MONITORING DISABLED Either Enable is FALSE or Speed[0] = 0.0%. 1 MONITORING STOPPED Motor not running, so not monitoring. 2 MONITORING STARTING Motor started less than Startup_Delay ago, so not monitoring yet. 3 LOAD NORMAL The actual Load is within the expected range, so anomaly detected. 4 LOAD HIGH WARNING The actual Load is above Hi_Warning_Level but not higher than Hi_Fault_Level. 5 LOAD LOW WARNING The actual Load is below Lo_Warning_Level but not lower than Lo_Fault_Level. 6 LOAD HIGH FAULT The actual Load is above Hi_Fault_Level. 7 LOAD LOW FAULT The actual Load is below Lo_Fault_Level.
Expected_Load	The calculated Load expected for the current Speed. This is determined from the load 'curve' specified by the Speed n and Load n parameters and is useful for checking if an unexpected warning or fault is reported.
Load_Error	The difference between Actual Load and Expected Load.
Delayed_Fault	Indicates if actual Load has been above Hi_Fault_Level or below Lo_Fault_Level for longer than Fault_Delay .

Functional Description

An estimate of the expected Load for any given Speed is specified using the Speed n and Load n parameters. Each pair provide a point on the expected Load line. The Speed parameters must have increasing values. That is: Speed 1 < Speed 2 < Speed 3 < Speed 4 < Speed 5 < Speed 6 < Speed 7 < Speed 8 < Speed 9 < Speed 10.

If not all points are required, a Speed may be set to zero to terminate the sequence. If the actual speed is greater than the last specified point, the line is extrapolated from the previous 2 points.

Speed 1 must be non-zero, otherwise the abnormal load detection feature is disabled.

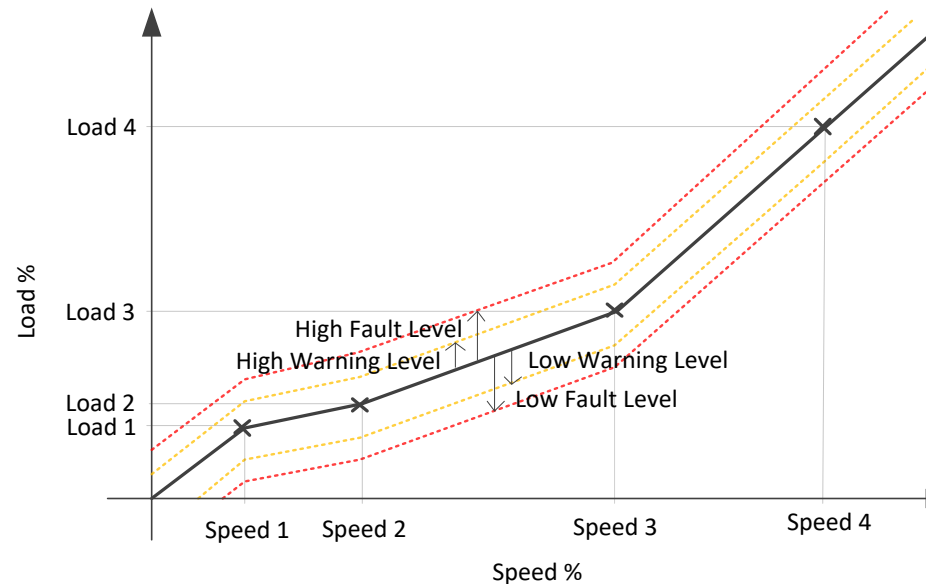

The expected load line is defined by the entered Speed and Load values. The Warning and Fault detection threshold load lines are offset from the expected load line. The deviation from normal behavior is determined by the **Hi_Fault_Level**, **Hi_Warning_Level**, **Lo_Warning_Level** and **Lo_Fault_Level** parameters. For the feature to function correctly **Hi_Fault_Level > Hi_Warning_Level > Lo_Warning_Level > Lo_Fault_Level**.

When running, the Load Monitor State diagnostic will show if the actual Load is in the NORMAL, WARNING or FAULT regions of the graph. If the actual Load remains in a FAULT region for longer than the duration specified by Fault Delay, the Drive will stop running.

The Start Delay may be used to prevent incorrect warning or fault reports soon after the Run command is issued.

The Load Monitor State diagnostic is reset when the Run command is removed.

E-6 Library Function Blocks

APPLICATION ALERT

The Application Alert function block may be used to create a message that will be displayed on the GKP.



Parameters

Variable	Description
ShowAlert	The Alert is shown on the rising edge of this input
ClearAlert	Clear this alert. Acknowledging the alert on the GKP will also clear the alert.
Line1	The text to show as the first line of the alert
Line2	The text to show as the second line of the alert

Functional Description

Create only one instance of the Application_Alert function block.

The alert message is shown on the GKP, obscuring any other display except for a fault message.

If more than one alert message is required, this can be achieved by selecting a different string for Line1 and Line2 while ShowAlert is FALSE.

The message is latched on the GKP by the rising edge of the ShowAlert input.

APPLICATION TRIPS

The Application Trips feature may be used to generate a trip from the application. This is typically used to generate a trip in response to a fault detected in the process.

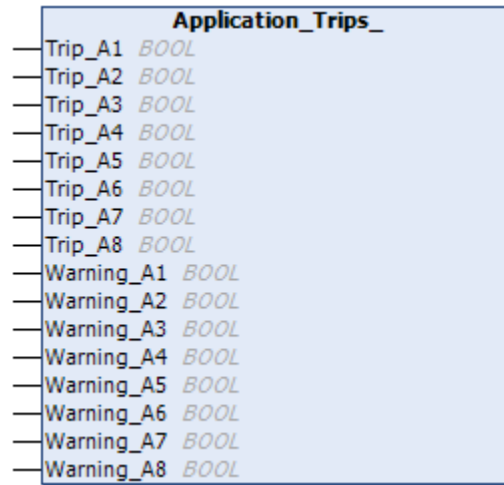

Parameters

Variable	Description
Trip_A1 to Trip_A8	The corresponding trip is active while this input is high. Application trip A1 corresponds to trip number 33. Application trip A8 corresponds to trip number 40.
Warning_A1 to Warning_A8	The corresponding trip warning is active while this input is high

E-8 Library Function Blocks

APPLICATION TRIPS TEXT

The Application Trips Text function block may be used in conjunction with the Application Trips function block to add customised text for the application trips and for the external trip.

Application_Trips_Text_	
— Trip_A1_Text	STRING(21)
— Trip_A2_Text	STRING(21)
— Trip_A3_Text	STRING(21)
— Trip_A4_Text	STRING(21)
— Trip_A5_Text	STRING(21)
— Trip_A6_Text	STRING(21)
— Trip_A7_Text	STRING(21)
— Trip_A8_Text	STRING(21)
— External_Trip_Text	STRING(21)

Parameters

Variable	Description
Trip_A1_Text to Trip_A8_Text	Define alternative text for the application trip.
External_Trip_Text	Define alternative text for the external trip.

Functional Description

When a trip is detected, a message is displayed on the GKP in the form:

```
*** TRIPPED ***  
TRIP DESCRIPTION
```

The default text shown on the GKP and web page for the application trips is “33 A1” to “40 A8”. The default text for the external trip is “14 EXTERNAL TRIP”. The default text can be over-ridden by defining text using the Application Trips Text block.

An alternate method to define alternate text for a trip is to use a custom language file. See application note “C013 Language Files” for details on how to create and use a custom language file.

BRAKE CONTROL

The Brake Control function block is used to control an electro-mechanical brake, typically in hoist and lift applications.

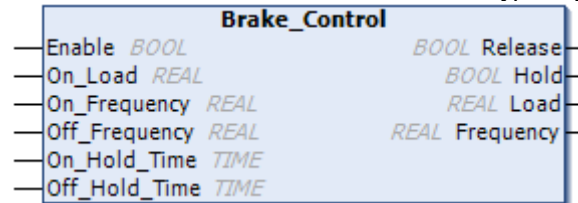
**Parameters**

Variable	Description
Enable	Set to TRUE to enable the brake control feature.
On_Load	Load level in % at which the external motor brake is released.
On_Frequency	Output electrical frequency in Hz at which the external motor break is released.
Off_Frequency	Output electrical frequency in Hz at which the external motor break is applied.
On_Hold_Time	Duration of the pulse output on Hold when Release becomes TRUE.
Off_Hold_Time	Duration of the pulse output on Hold when Release becomes FALSE.
Release	Output to the brake. Release is forced false if Brake_Control is not enabled.
Hold	Becomes TRUE when Release changes from TRUE to FALSE or from FALSE to TRUE. It remains TRUE for the duration set by On_Hold_Time and Off_Hold_Time .
Load	The load in %.
Frequency	The output electrical frequency in Hz.

E-10 Library Function Blocks

Functional Description

The operation of the Brake Control feature is illustrated below.

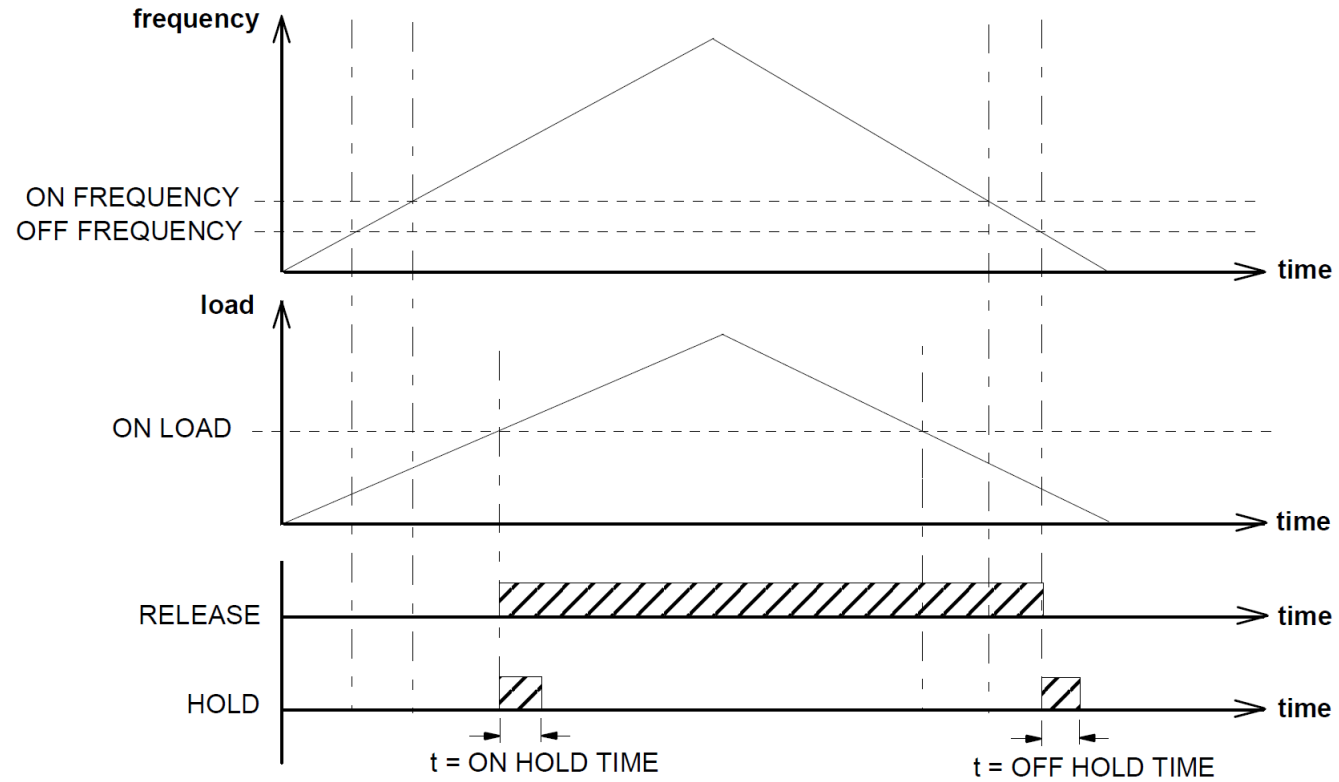

DATA LOGGER INT

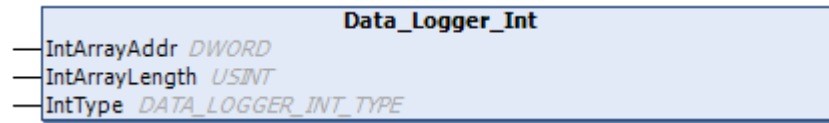
**Parameters**

Variable	Description
IntArrayAddr	Address of the integer values to add to the data logger output.
IntArrayLength	Number of integer values to add to the data logger output.
IntType	Defines the integer type: 0 Signed 32-bit integer 1 Unsigned 32-bit integer 2 32-bit integer printed as a hexadecimal value.

Functional Description

See below, Data Logger Real.

DATA LOGGER REAL

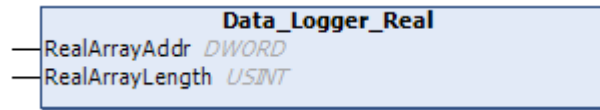
**Parameters**

Variable	Description
RealArrayAddr	Address of the real values to add to the data logger output.
RealArrayLength	Number of real values to add to the data logger output.

E-12 Library Function Blocks

Functional Description

The data logger blocks may be used to extend the parameters recorded by the standard data logger, refer to Appendix C. If it is necessary to log more than 8 parameters then the number of parameters to be logged may be increased to 40 in total, (an additional 32), by adding the Data_Logger_Int and / or the Data_Logger_Real blocks. The variables to be logged are to be gathered into an array of Long Integers, or an array of Reals and attached to the logger blocks, as illustrated here:

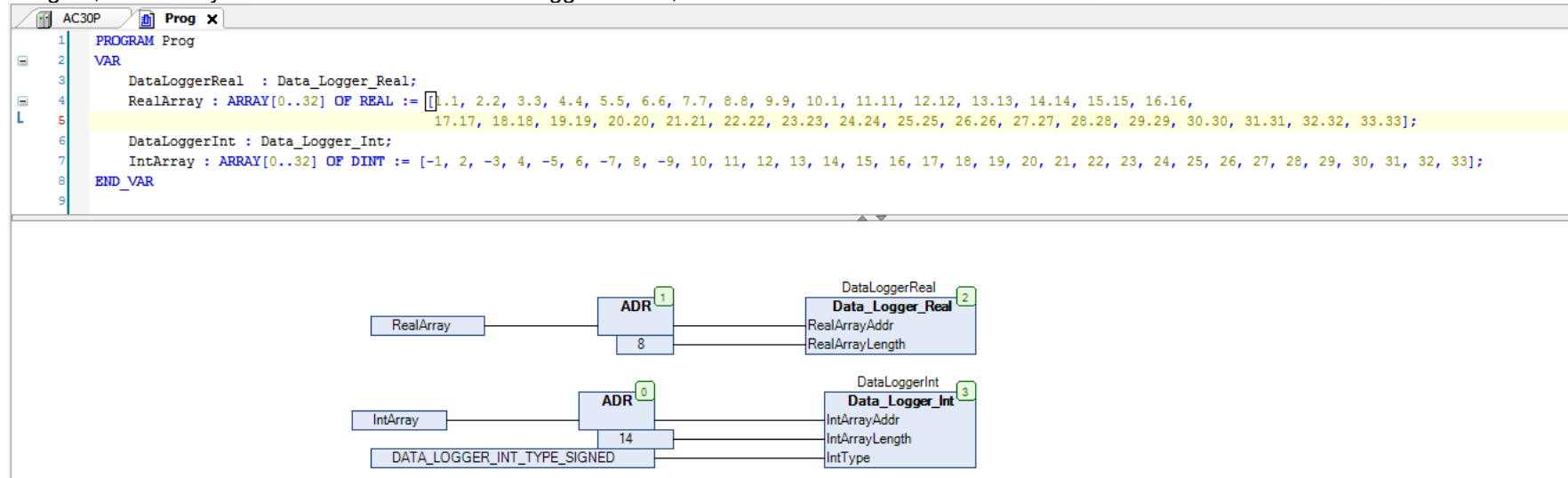

Here, the RealArray and IntArray variables are initialized with values, but in practice the values will be updated from application variables and fixed parameter values as part of the application program.

FILTER

FILTER 2

Filter_2 implements a single poll low pass filter. Filter_2 is identical to Filter, with a wider input range.

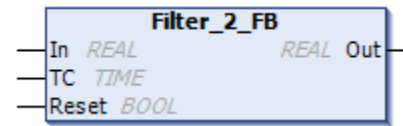

Parameters

Variable	Description
In	The input value to be filtered, clamped to be between -32768.0 and 32768.0.
TC	The time constant with a range 0.01 to 300.00 seconds.
Reset	When TRUE, the internal filter variables are reset and Out is set to equal In.
Out	The output of the filter.

Functional Description

The filter is implemented as a single poll filter. For a step change in the input, the time constant is the time the output takes to reach 63% of the change in the input value.

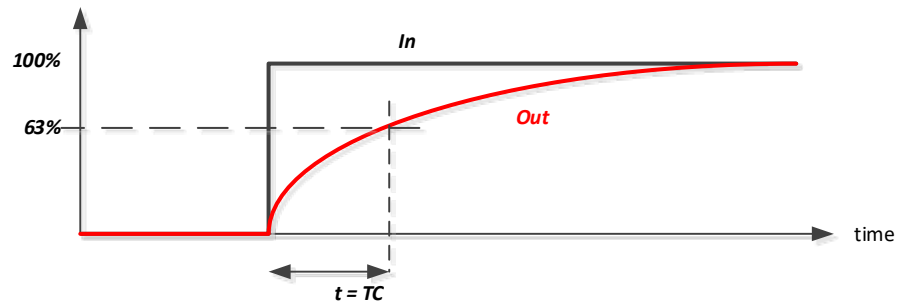

As with all blocks, the Filter_2 block is executed once each time the application is updated. The default application update rate is 5ms. The filter block will not operate correctly if the application update rate is longer than half the time constant.

E-14 Library Function Blocks

FIRE MODE

This block is used to configure the fire mode feature, detailed in chapter 9.

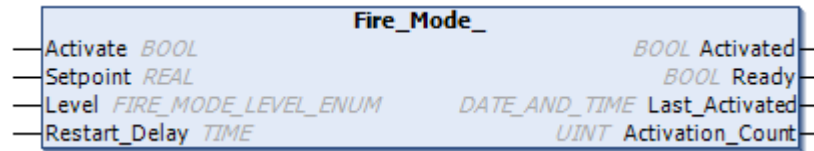

Parameters

Variable	Description
Activate	Set to TRUE to enable Fire Mode according to the Fire Mode parameter. Intended to be connected to a digital input.
Setpoint	A reference value to be used when Fire Mode is active. Setting a negative setpoint will cause the drive to rotate in reverse direction. Default value 0.0%. Range -100% to 100%
Level	An enumerated input parameter. Selects the mode of operation when Fire Mode is enabled 0. DISABLED 1. PARTIAL 2. FULL Default value is DISABLED.
Restart_Delay	Specifies the time to wait before attempting to reset a trip.
Activated	Indicates when Fire Mode is active. This is TRUE when Level is either PARTIAL or FULL, the Setpoint is not 0.0% and Activate is TRUE.
Ready	Indicates when Fire Mode will be activated if Activate is set TRUE. This is TRUE when Level is either PARTIAL or FULL and the Setpoint is not 0.0%.
Last_Activated	Records the last time that the fire mode became active. This may be used to validate that the fire mode has been tested. This value is recorded in non-volatile memory. The value will be reset if an application is loaded that does not implement Fire Mode.
Activation_Count	Records the number of times the fire mode has become active. This value is saved in non-volatile memory. The activation count will be reset if an application is loaded that does not implement Fire Mode.

Functional Description

The Fire Mode feature is described in Chapter 9.

HOME

To stop a drive in a set distance using a position loop.

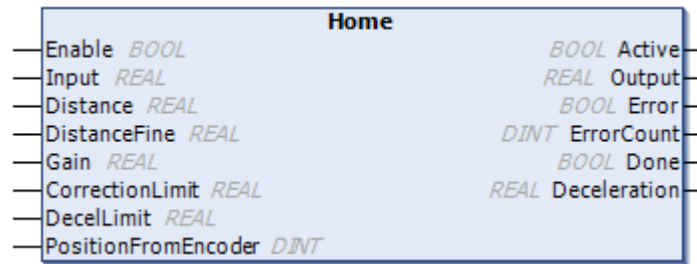

Parameters

Variable	Default	Description
Enable	FALSE	Changing Enable from FALSE to TRUE initiates a position home operation.
Input	0.0	Speed input in %, limited internally to between -300.0% and 300.0%.
Distance	1.0	Homing distance in revolutions: 1.0 corresponds to 65536 counts into PositionFromEncoder . Limited to between 0.0 and 300.0 revolutions
DistanceFine	0.0	Fine adjustment of homing distance. Limited to between 0.0 and 1.0 revolution.
Gain	5.0	Gain of the position loop in closed loop homing. Limited to between 0.0 and 1000.0.
CorrectionLimit	5.0	Maximum value of the closed loop position in %. Limited to between 0.0 and 100.0 %.
DecelLimit	100.0	Maximum deceleration for Closed Loop homing. Limited to between 0.0 and 3000.0 %/s.
PositionFromEncoder	0	Position feedback from the encoder, with a scaling of 65536 counts for 1 revolution
Active		Indicates that the homing feature is active.
Output		Speed demand in %. Connect this to a speed input, for example parameter PNO 1266 Speed Trim.
Error		TRUE if maximum deceleration exceeded
ErrorCount		Actual position error in counts, with 65536 = 1 revolution. Only valid when Homing is Active
Done		TRUE when position has been reached
Deceleration		Actual deceleration used during the Homing operation in %/s.

Functional Description

For accurate positioning the drive must be in closed loop mode and the **PositionFromEncoder** input fed with position information. If the drive is in any other mode, then an open loop home algorithm will be used.

The distance is set in revolutions, usually from a mark at a fixed distance from the home position. One revolution corresponding to 65536 counts on the **PositionFromEncoder** input.

When using Home, the Output should override the System Ramp.

When Home is not enabled, **Output** is set equal to **Input**, (with an update rate corresponding to the application update rate, default is 5ms).

E-16 Library Function Blocks

KTY 84 130 CONVERTER

KTY 84-130 conversion from resistance value to temperature in °C

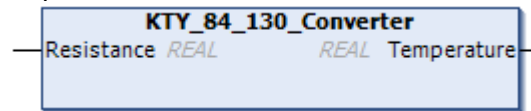

Parameters

Variable	Description
Resistance	Resistance of KTY thermistor in ohms
Temperature	Output, temperature in °C from resistance value input

LINEAR FIT

Linear approximation of an input to a general function.

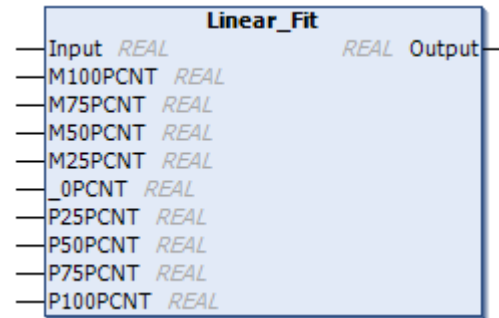
**Parameters**

Variable	Description
Input	Input value in percent. Expected to be in the range -100.0% to 100.0%
M100PCNT	Output value for -100.0% input
M75PCNT	Output value for -75.0% input
M50PCNT	Output value for -50.0% input
M25PCNT	Output value for -25.0% input
_0PCNT	Output value for 0.0% input
P25PCNT	Output value for 25.0% input
P50PCNT	Output value for 50.0% input
P75PCNT	Output value for 75.0% input
P100PCNT	Output value for 100.0% input
Output	The output value corresponding to Input.

Functional Description

Performs a linear interpolation for inputs between these points. If **Input** is less than -100.0%, then **Output** is clamped to **M100PCNT**. Similarly, if **Input** is greater than 100.0%, then **Output** is clamped to **P100PCNT**.

E-18 Library Function Blocks

LINEAR FIT 2

Linear approximation of an input to a general function.

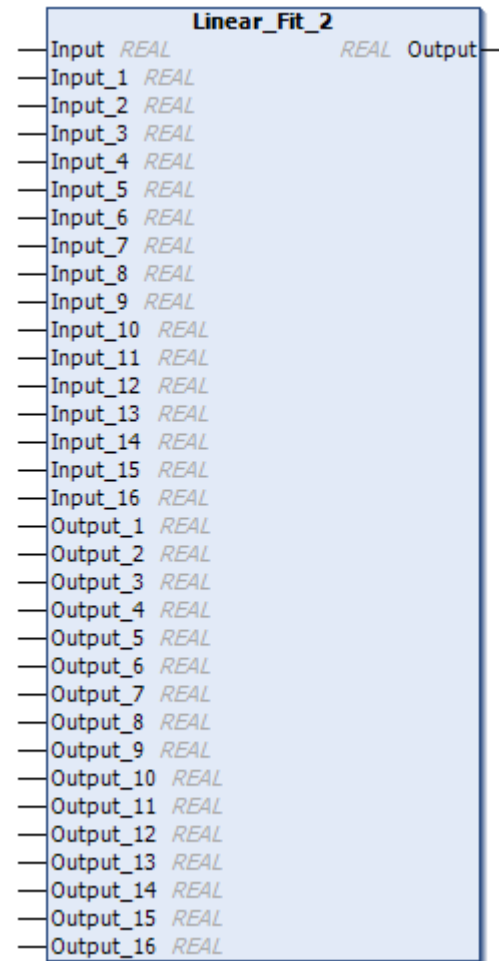

Parameters

Variable	Description
Input	The input to the block
Input_1	Input value corresponding to Output_1
:	
Input_16	Input value corresponding to Output_16
Output_1	Output value corresponding to Input_1
:	
Output_16	Output value corresponding to Input_16
Output	Output value corresponding to mapped Input

Functional Description

The input profile should always increase from minimum value at **Input_1** to a maximum value. If not, then the Last Input validated for the profile is the highest one found in the table. If Input is outside the min/max value, then Output is set to the corresponding output min/max value. Performs a linear interpolation for inputs between these points. The default values match a KTY 84-130 thermal sensor as shown:

N	Input	Output
1	498.0	0.0
2	626.0	30.0
3	722.0	50.0
4	773.0	60.0
5	826.0	70.0
6	882.0	80.0
7	940.0	90.0
8	1000.0	100.0

N	Input	Output
9	1062.0	110.0
10	1127.0	120.0
11	1194.0	130.0
12	1262.0	140.0
13	1334.0	150.0
14	1407.0	160.0
15	1482.0	170.0
16	1560.0	180.0

E-20 Library Function Blocks

LINEAR RAMP

Controlled variation of an input using predefined acceleration and deceleration rate, linear mode

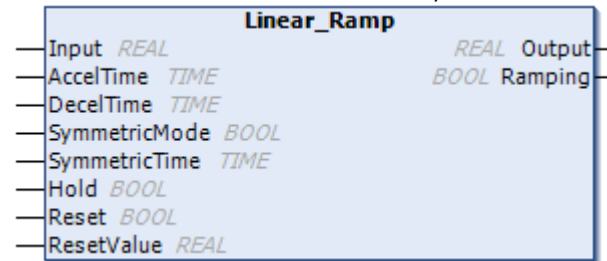

Parameters

Variable	Description
Input	Input to the ramp
AccelTime	Time the inverter will take to ramp the setpoint from 0% to 100%
DecelTime	Time the inverter will take to ramp the setpoint from 100% to 0%
SymmetricMode	Set FALSE to use AccelTime and DecelTime . Set TRUE to use or SymmetricTime for ramping up and down.
SymmetricTime	Replace AccelTime and DecelTime if SymmetricMode set to TRUE
Hold	When TRUE, output ramp is held to its last value
Reset	When TRUE, output is made equal to ResetValue
ResetValue	Value that the Output is set to while Reset is TRUE
Output	Ramp output
Ramping	Indicates that the output is ramping.

Functional Description

The linear ramp operates to ramp Output towards Input at a rate determined by **AccelTime** & **DecelTime** or **SymmetricTime**. Acceleration is defined as ramping away from zero. Deceleration is defined as ramping towards zero.

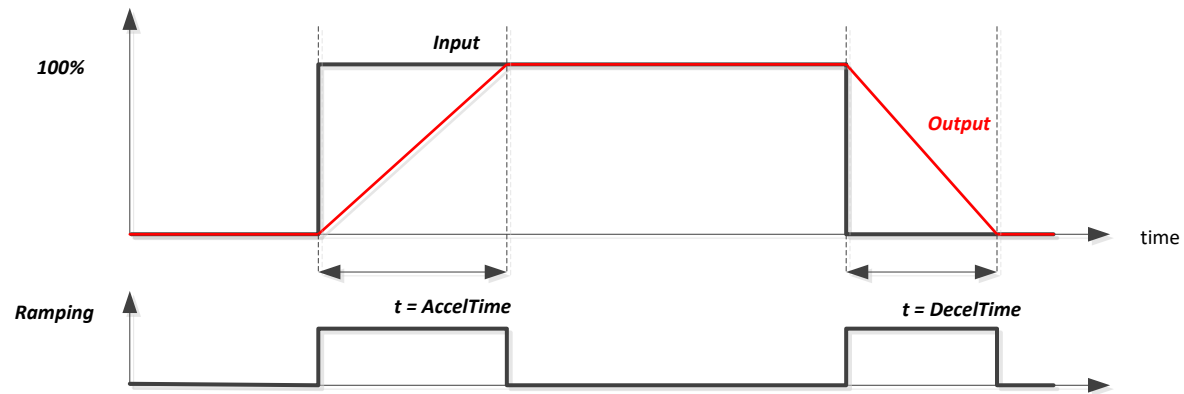

E-22 Library Function Blocks

MINIMUM SPEED2

Determines how the reference will be followed.

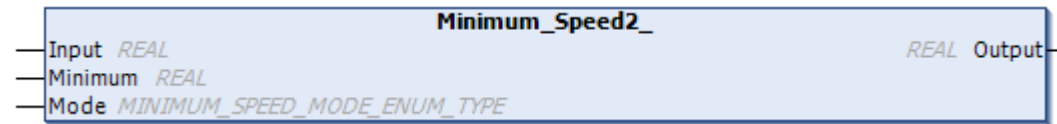

Parameters

Variable	Description
Input	The speed setpoint input as a percentage of maximum speed.
Minimum	The minimum limit, defaults to -100%.
Mode	Defines the minimum speed mode, see Functional Description below.
Output	The transformed speed setpoint output as a percentage of maximum speed.

Functional Description

There are two operating modes for the MINIMUM SPEED function:

PROP WITH MINIMUM (proportional with minimum)

In this mode the MINIMUM SPEED function behaves like a simple clamp. The Minimum Speed Value has the valid range -100% to 100% and the output is always greater than or equal to the Minimum Speed Value.

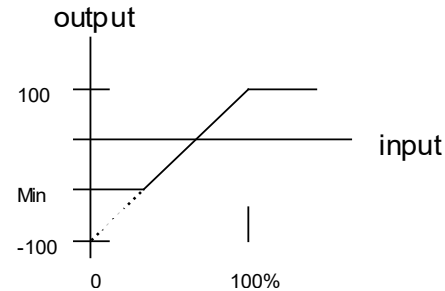

LINEAR

In this mode the MINIMUM SPEED function first clamps the input to zero then rescales the input such that the output goes linearly between minimum and 100% for an input that goes from 0 to 100%.

In both modes, note the constraints:

- Minimum ≥ -100
- Input ≥ -100
- Maximum = 100%

NTC THERMISTOR CONVERTER

The NTC Thermistor Converter feature converts a resistance in ohms to a temperature in °C.



Parameters

Variable	Description
Resistance	The measured resistance of the NTC thermistor in ohms.
ReferenceTemperature	The reference temperature for the NTC thermistor, usually 25 °C or 0 °C.
ReferenceResistance	The resistance of the NTC thermistor at the reference temperature.
Beta	The beta value for the NTC thermistor.
Temperature	The temperature corresponding to Resistance for the thermistor.

Functional Description

The NTC Thermistor Converter uses the approximation formula

$$R_T = R_N \cdot e^{\beta \cdot (1/T - 1/T_N)}$$

$$\text{or } T = (1/\beta \cdot \ln(R_T/R_N) + 1/T_N)^{-1}$$

Where:

- R_T is the resistance at temperature T .
- R_N is the resistance at the reference temperature.
- T_N is the reference temperature
- β is the beta value for the thermistor.

E-24 Library Function Blocks

NTC TRIP LEVELS

The NTC Trip Levels feature is designed to allow configuration of the thermistor trip block using temperature variables instead of the resistance values used by the drive parameters.

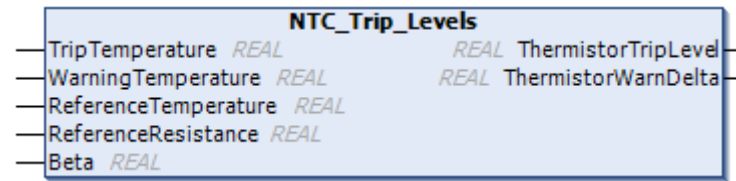

Parameters

Variable	Description
TripTemperature	The temperature above which the thermistor trip should be active.
WarningTemperature	The temperature above which the thermistor temperature warning should be active.
ReferenceTemperature	The reference temperature for the NTC thermistor, usually 25 °C or 0 °C.
ReferenceResistance	The resistance of the NTC thermistor at the reference temperature.
Beta	The beta value for the NTC thermistor.
ThermistorTripLevel	The resistance in ohms corresponding to TripTemperature
ThermistorWarnDelta	The resistance in ohms corresponding to the difference between TripTemperature and WarningTemperature .

Functional Description

The NTC Trip Levels block uses the approximation formula

$$R_T = R_N * e^{\beta * (1/T - 1/T_N)}$$

Where:

- R_T is the resistance at temperature T.
- R_N is the resistance at the reference temperature.
- T_N is the reference temperature
- β is the beta value for the thermistor.

The outputs **ThermistorTripLevel** and **ThermistorWarnDelta** are designed to be connected to the Thermistor parameters, PNO1004 Thermistor Trip Level and PNO1762 Thermistor Warn Delta. This can be done in the application using the Thermistor_Input block.

PID

This function allows the AC30V to be used in applications requiring a trim to the reference, depending on feedback from an external measurement device. Typically, this will be used for process control, i.e. pressure or flow.

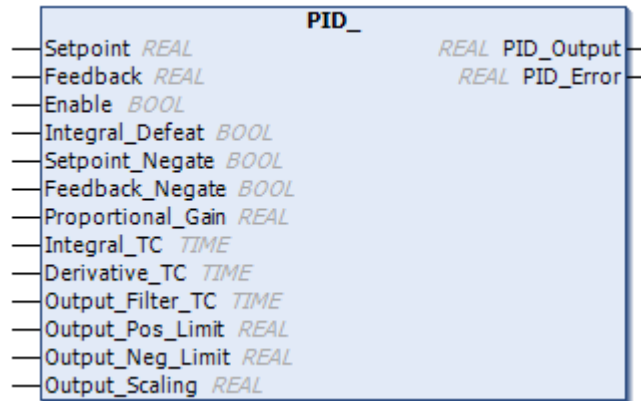
**Parameters**

Variable	Description
Setpoint	The desired setpoint, typically connected to an Analog Input as part of the selected macro.
Feedback	The measured process variable, typically connected to an Analog Input as part of the selected macro.
Enable	Resets the PID output and integral term when FALSE. Enable must be TRUE for the PID to operate.
Integral_Defeat	Resets the p integral term when FALSE.
Setpoint_Negate	Changes the sign of the Setpoint input
Feedback_Negate	Changes the sign of the Feedback input
Proportional_Gain	This is the true proportional gain of the PID controller. When set to zero the PID_Output is zero.
Integral_TC	Integral term time constant
Derivative_TC	Derivative term time constant
Output_Filter_TC	Time constant for the first order filter applied to PID_Output .
Output_Pos_Limit	Upper limit on the output applied before the output scaling factor.
Output_Neg_Limit	Lower limit on the output applied before the output scaling factor.
Output_Scaling	Scaling factor applied to the output to create PID_Output
PID_Output	The output of the PID algorithm after limits and clamps.
PID_Error	Difference between Setpoint and Feedback , after negates. Limited to between -100.0 and 100.0

E-26 Library Function Blocks

Functional Description

The operation of the PID is as illustrated here.

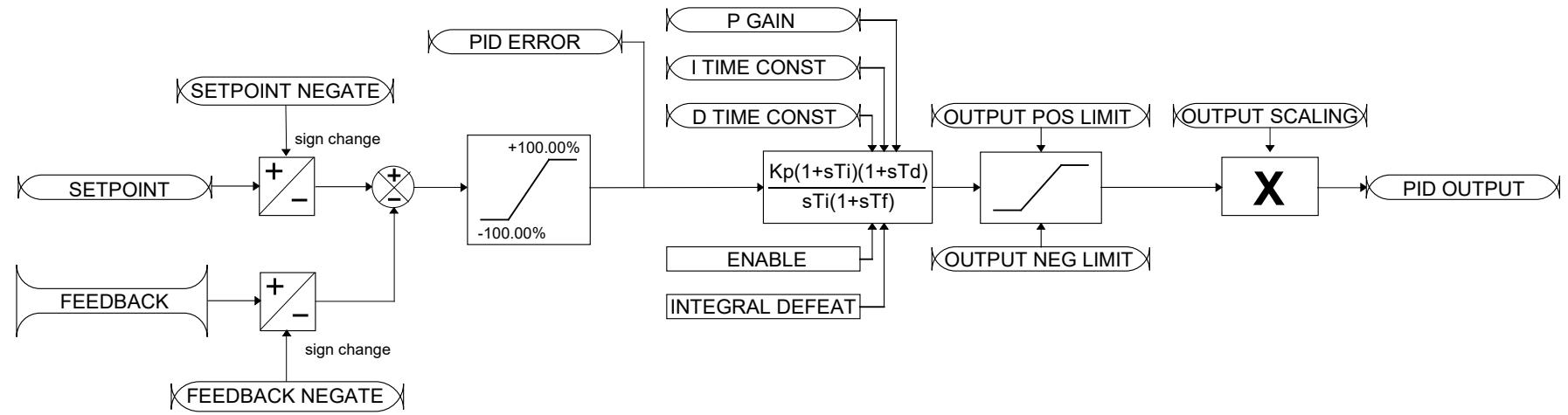

POSITION

The Position FB counts the encoder position input from reset. It provides a scaled output. **Counts** input must be connected to an encoder count output.

**Parameters**

Variable	Description
Counts	The input to the block, should be connected to the output counts from an encoder.
Reset	Reset Output to Zero and Scaled_Output to Preset when set to TRUE
Preset	The value to which Scaled_Output is set when Reset is TRUE
Counts_Per_Unit	The number of encoder counts that are equal to a Scaled_Output of 1.0
Limit_	A symmetric limit that clamps the value of Scaled_Output . Scaled_Output cannot be greater than Limit_
Output	The number of encoder counts since the block was last reset. This output is preserved during power down of the drive
Scaled_Output	An output scaled such as $1.0 = \text{Counts} / \text{Counts_Per_Unit}$

E-28 Library Function Blocks

PRESETS2

Selects one of 8 values.

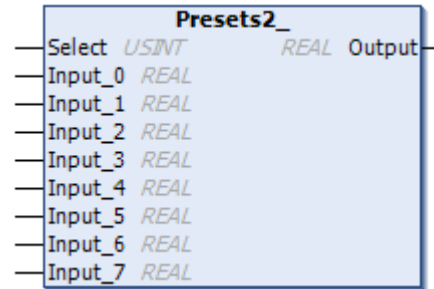

Parameters

Variable	Description
Select	Select which input to use as the Output, 0 to 7.
Input_0 to Input_7	The discrete values to use for Output, depending on Select.
Output	Set to the selected input,

Functional Description

The Preset block is used to select one of eight pre-defined values. If Select is set outside the range 0 ... 7 then Output will be set to 0.0.

The use of this block in the default application is shown in Appendix C

PT1000 CONVERTER

The PT1000 Converter feature converts a resistance in ohms to a temperature in °C for a PT1000 thermistor.

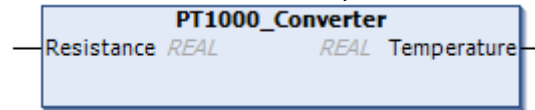

Parameters

Variable	Description
Resistance	The measured resistance of the PT1000 thermistor in ohms.
Temperature	The temperature corresponding to Resistance for the thermistor.

Functional Description

The PT1000 Converter uses the approximation formula

$$T = -244.91 + (0.23431 * R) + (0.000010623 * R^2)$$

Where:

- R is the resistance at temperature T.

PT1000 TRIP LEVELS

The PT1000 Trip Levels feature is designed to allow configuration of the thermistor trip block using temperature variables instead of the resistance values used by the drive parameters.

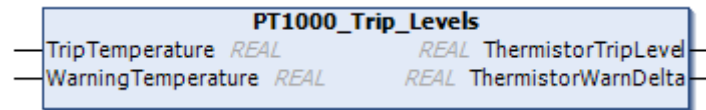

Parameters

Variable	Description
TripTemperature	The temperature above which the thermistor trip should be active.
WarningTemperature	The temperature above which the thermistor temperature warning should be active.
ThermistorTripLevel	The resistance in ohms corresponding to TripTemperature
ThermistorWarnDelta	The resistance in ohms corresponding to the difference between TripTemperature and WarningTemperature .

Functional Description

The PT1000 Trip Levels block uses the approximation formula

$$R = 1000 + (3.9083 * T) - (0.0005775 * T^2)$$

Where:

- R is the resistance at temperature T.

The outputs **ThermistorTripLevel** and **ThermistorWarnDelta** are designed to be connected to the Thermistor parameters, PNO1004 Thermistor Trip Level and PNO1762 Thermistor Warn Delta. This can be done in the application using the Thermistor_Input block.

E-30 Library Function Blocks

QUEUE PARAMETER WRITE

The Queued Write Control block works together with the Queue Parameter Write block to allow the application to write to parameters that can only be written to when the application is not running.



Parameters

Variable	Description
Value	The value to be written to the selected parameter.
PNO	The PNO of the parameter to write to.
Different	Indicates if "Value" is different from the current value of the parameter selected by PNO.

QUEUED WRITE CONTROL

The Queued Write Control block works together with the Queue Parameter Write block to allow the application to write to parameters that can only be written to when the application is not running.

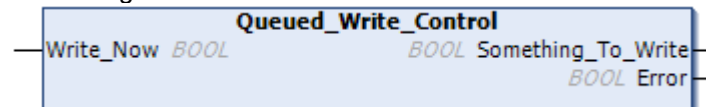

Parameters

Variable	Description
Write_Now	Changing this value from FALSE to TRUE activates all the queued writes.
Something_To_Write	At least one of the queued writes is different from the actual value of the parameter selected.
Error	The most recent write failed. For example, the write will fail if the motor is running.

Functional Description

Some parameters can only be written to when the drive is in a safe state, for example, the communications option type. These parameters typically need to be set just once to configure the product. If one or more of these parameters needs to be configured automatically, this can be done within the application using the queued write blocks. One "Queue_Parameter_Write" block is required for each parameter that is to be configured by the application in addition to one "Queued_Write_Control" block. The following example program illustrates how to set the comms option and the IO option types to match the fitted options.

```

PROGRAM PLC_PRG
VAR
  {attribute 'device_parameter' := '1178'}
  io_option_required : USINT;          (* For information only *)
  {attribute 'device_parameter' := '1179'}
  io_option_fitted : USINT;
  {attribute 'device_parameter' := '44'}
  comms_option_required : USINT;      (* For information only *)
  {attribute 'device_parameter' := '45'}
  comms_option_fitted : USINT;
  Queue_Parameter_Write_1178 : Queue_Parameter_Write;
  Queue_Parameter_Write_44 : Queue_Parameter_Write;
END_VAR

```

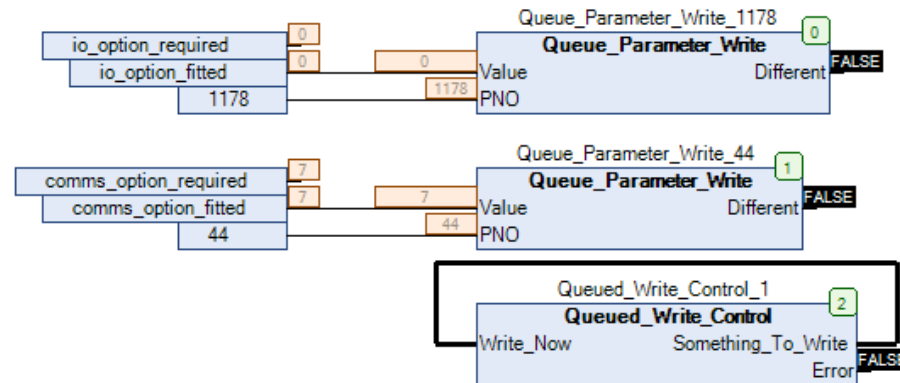

This CFC diagram shows an example where `Queued_Write_Control` is activated automatically if either of the queued parameter values is different from the value in the drive. In this example the drive has no IO option fitted and a DEVICenet communications option. Initially the required comms option is set to NONE, but this is automatically set to match the actual option fitted when the application starts. The queued write control feature works by stopping the application, executing the queued parameter writes then starting the application. This feature is not suitable for writing to parameters that may need to be frequently changed while the application is running. The feature will fail if the drive is running, (actively controlling a motor), as it is not permitted to stop the application in this case.

E-32 Library Function Blocks

RAISE LOWER

The Raise/Lower function acts as an internal motorized potentiometer (MOP) used as a reference source.

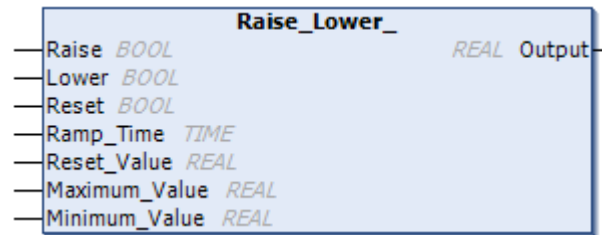

Parameters

Variable	Description
Raise	When TRUE and Lower is FALSE, Output is ramped up to Maximum_Value
Lower	When TRUE and Raise is FALSE, Output is ramped down to Minimum_Value
Reset	When TRUE forces Output to track Reset Value,
Ramp_Time	Rate of change of the Output. Defined as the time to change from 0.00% to 100.00%. Note that the raise and lower rates are always the same.
Reset_Value	Output is set to Reset_Value when Reset is TRUE.
Maximum_Value	The maximum value to which Output will ramp up to. If Minimum_Value is greater than Maximum_Value then Output is set to Maximum_Value .
Minimum_Value	The minimum value to which Output will ramp down to. If Minimum_Value is greater than Maximum_Value then Output is set to Maximum_Value .
Output	The output of the Raise Lower block, typically used as the motor speed setpoint.

Functional Description

The table below describes how Output is controlled by Raise, Lower and Reset.

Reset	Raise	Lower	Action
TRUE	Any	Any	Output tracks Reset Value, clamped between Minimum_Value and Maximum_Value.
FALSE	TRUE	FALSE	Output ramps up to Maximum Value at Ramp Time
FALSE	FALSE	TRUE	Output ramps down to Minimum Value at Ramp Time
FALSE	FALSE	FALSE	Output not changed. *
FALSE	TRUE	TRUE	Output not changed. *

* If Output is greater than Maximum Value the Output will ramp down to Maximum Value at Ramp Time. If Output is less than Minimum Value the Output will ramp up to Minimum Value at Ramp Time.

If Maximum Value is less than or equal to Minimum Value, then Output is set to Maximum Value.

The use of this block in the default application is described in Appendix C.

READ DATA FROM SD CARD

The Read_Data_From_SD_Card may be used to read a block of binary data from an SD Card into memory in the AC30 drive.

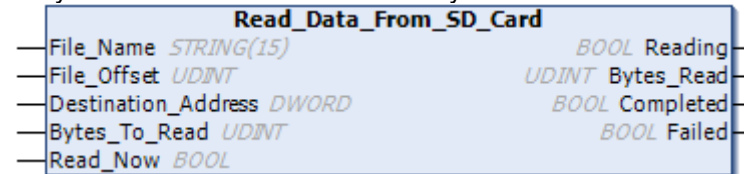
**Parameters**

Variable	Description
File_Name	The name of the file on the SD Card. The file must be in the root of the SD Card.
File_Offset	The offset from the start of the file to start reading from. If the offset is beyond the end of the file then Bytes_Read will return zero.
Destination_Address	The address of the buffer into which the data is to be read. This must be at least as long as the value in Bytes_To_Read .
Bytes_To_Read	The number of bytes to attempt to read from the SD Card.
Read_Now	Changing this input from FALSE to TRUE starts the read. Changing Read_Now to FALSE before the read is completed will abort the read. Typically, Read_Now should be set back to FALSE only when the read is complete.
Reading	TRUE while the read is in progress.
Bytes_Read	Indicates how many bytes were read from the SD Card once the read is complete.
Completed	When TRUE, indicates that the read attempt has completed. This value is reset to FALSE when Read_Now is set back to FALSE.
Failed	When TRUE, indicates that the read attempt failed. This value is reset to FALSE when Read_Now is set back to FALSE.

Functional Description

This block is intended for applications where a significant amount of data is required that is too large to be built into the application, or that needs to be updated independently from the application. An example that may make use of this feature could be a set of thermocouple linearization curves. Each curve could consist of 100 co-ordinates representing milli-volts and temperature. Saving each co-ordinate as a pair of REAL numbers would take 8 bytes per co-ordinate, or 800 bytes for the entire curve. Curves for 10 thermocouples would then create a file on the SD Card that would be 8000 bytes in size. Data for the first thermocouple would start at offset 0, the second would start at offset 800, e.t.c. To use the data, it needs to read into an array of 200 REAL values. The use of the data in the array must match the organization of the data in the file.

E-34 Library Function Blocks

SEQUENCING LOGIC2

The Sequencing Logic2 block provides a simple interface to the sequencing logic in the drive for the application. The block interacts with parameters PNO 0610 App Control Word and PNO 0661 Status Word.

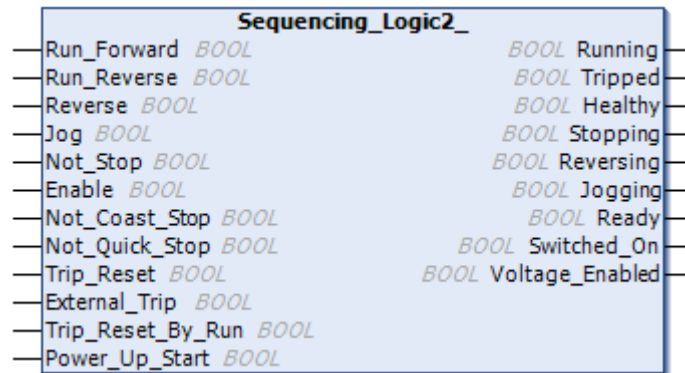

Parameters

Variable	Description
Run_Forward	Combined with Run_Reverse and Jog to control bit 3 of App Control Word, Enable Operation.
Run_Reverse	Combined with Run_Reverse and Jog to control bit 3 of App Control Word, Enable Operation.
Reverse	Maps directly to bit 13 of App Control Word, Reverse Direction
Jog	Combined with Run_Forward and Run_Reverse to control bit 3 of App Control Word, Enable Operation.
Not_Stop	When TRUE latches the Run Forward and Run Reverse inputs.
Enable	Maps directly to bit 1 of App Control Word, Coast Stop, OFF2
Not_Coast_Stop	Maps directly to bit 0 of App Control Word, Switch On, OFF1
Not_Quick_Stop	Maps directly to bit 2 of App Control Word, Not Quickstop, OFF3
Trip_Reset	Maps directly to bit 7 of App Control Word, Reset Fault.
External_Trip	Maps directly to bit 8 of App Control Word, External Fault
Trip_Reset_By_Run	When TRUE the Sequencing Logic2 will attempt to clear a trip by toggling bit 7 of App Control Word as part of the start-up sequence.
Power_Up_Start	Inverted, then mapped to bit 15 of App Control Word, Event Triggered Operation Setting Power_Up_Start could cause the motor to start unexpectedly.
	
Running	Mapped directly from bit 2 of Status Word, Operation Enabled
Tripped	Mapped directly from bit 3 of Status Word, Faulted

Variable	Description
Healthy	Healthy is TRUE if Tripped is FALSE or bit 3 of App Control word, Enable Operation, is FALSE. Indicates that the drive is not faulted, or the drive is not running.
Stopping	Mapped directly from bit 15 of Status Word, Stopping
Jogging	Mapped directly from bit 12 of Status Word, Jog Operation
Ready	Mapped directly from bit 0 of Status Word, Ready To Switch On
Switched_On	Mapped directly from bit 1 of Status Word, Switched On
Voltage_Enabled	Mapped directly from bit 4 of Status Word, Voltage Enabled

Functional Description

The operation of the sequencing logic in the drive is described in Appendix B and Appendix C.

E-36 Library Function Blocks

SKIP FREQUENCIES

Used to avoid resonances in the mechanical system.

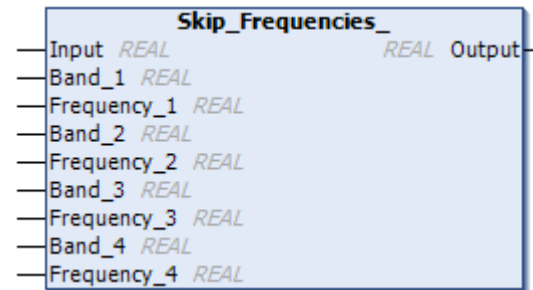

Parameters

Variable	Description
Input	The speed setpoint as a percent of PNO 0464 "100% Speed in RPM".
Band_1	Center point of resonance band 1 in motor electrical Hz.
Frequency_1	The width of resonance band 1 in motor electrical Hz.
Band_2	Center point of resonance band 2 in motor electrical Hz.
Frequency_2	The width of resonance band 2 in motor electrical Hz.
Band_3	Center point of resonance band 3 in motor electrical Hz.
Frequency_3	The width of resonance band 3 in motor electrical Hz.
Band_4	Center point of resonance band 4 in motor electrical Hz.
Frequency_4	The width of resonance band 4 in motor electrical Hz.
Output	The speed setpoint avoiding the defined resonance bands.

Functional Description

Four programmable skip frequencies are available to avoid resonances within the mechanical system. Enter the value of frequency that causes the resonance using a Frequency parameter and then program the width of the skip band using its Band parameter. The Drive will then avoid sustained operation within the forbidden band as shown in the diagram. The skip frequencies are symmetrical and thus work in forward and reverse.

Setting a Frequency to 0 disables the corresponding band. Setting a Band to 0 causes the value of Band 1 to be used for this band.

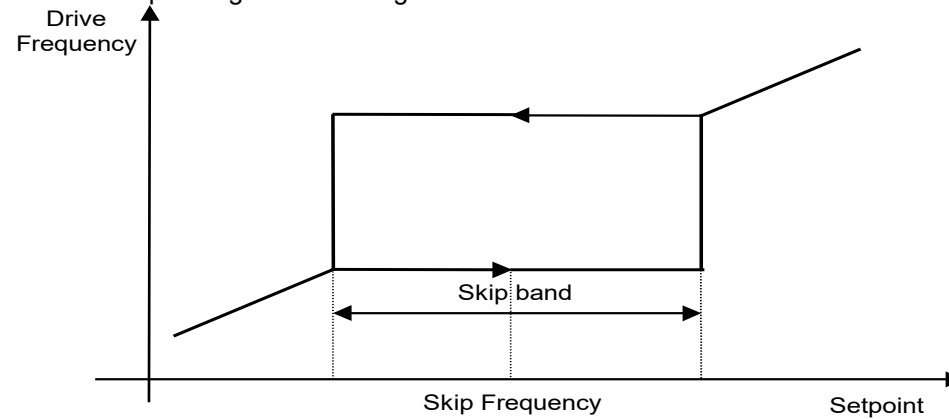

When two or more bands overlap, the bands are effectively combined into a single larger range to avoid, as illustrated below.

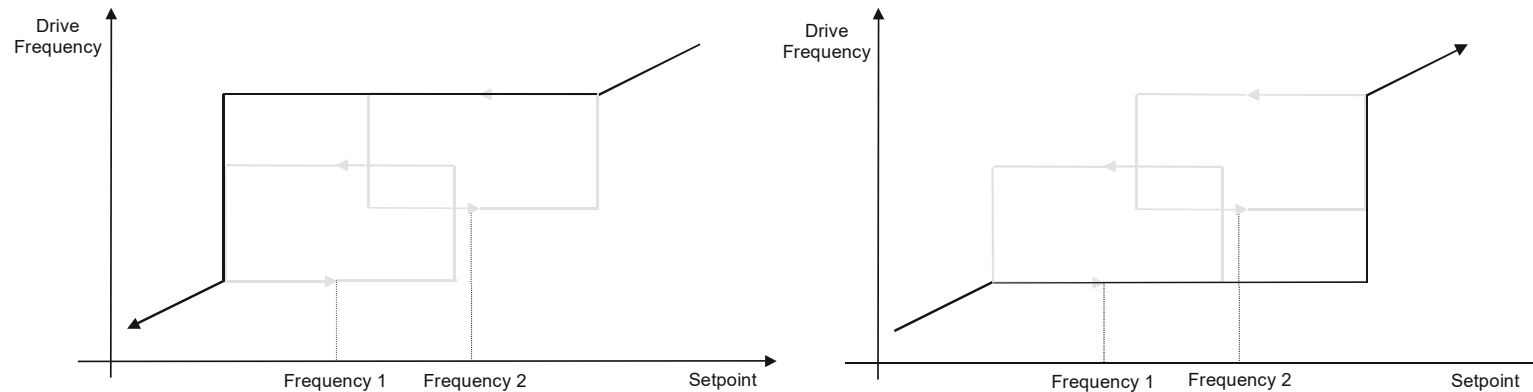

The operation of the Skip Frequencies block in the default application is described in Appendix C.

E-38 Library Function Blocks

SPEED SENSOR FAULT RIDE THROUGH

Allows switching automatically to sensorless operation in case of a speed sensor failure

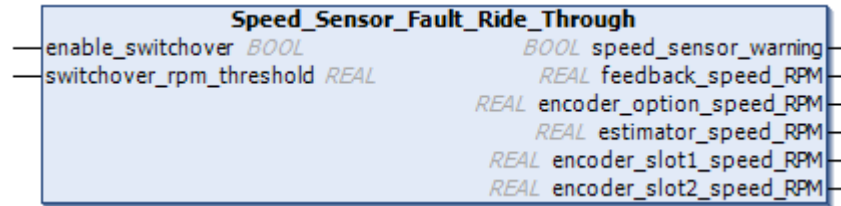

Parameters

Variable	Default	Description
enable_switchover	TRUE	Enables/disables the ability to automatically switch to sensorless operation. Configures drive parameter PNO 1701 Switchover Enable in the MRAS block
switchover_rpm_threshold	300.0	Speed level in RPM required as difference between encoder and estimator to trigger switch.
speed_sensor_warning		TRUE if switch has occurred.
feedback_speed_RPM		Feedback speed value that is used in the control loops
encoder_option_speed_RPM		Encoder speed measurement - from option
estimator_speed_RPM		Estimator speed measurement
encoder_slot1_speed_RPM		Encoder speed measurement - from system board slot 1
encoder_slot2_speed_RPM		Encoder speed measurement - from system board slot 2

Functional Description

The Speed Sensor Fault Ride Through feature allows the drive to automatically, and as seamlessly as possible, continue operating in sensorless mode in case of an encoder failure. The MRAS estimator tracks the speed of the motor even if the drive uses an encoder as its primary feedback for control. If the discrepancy between the speed measured by the encoder and the estimated speed is greater than **switchover_rpm_threshold** it is assumed that the encoder has malfunctioned, and control will automatically be transferred to use estimated speed as its feedback signal. The drive will continue to work in sensorless mode until the next stop cycle. There will be no attempt to 'reconnect' the encoder on the fly even if its signal recovers. Upon the move to sensorless operation **speed_sensor_warning** is set TRUE.

The switchover will not be performed, even if enabled

- during autotune sequence
- if flycatching is enabled until the estimator converges to correct speed (typically within first 50-100ms after starting the drive), and until the motor has accelerated to 95% of its initial speed setpoint.
- if the setpoint speed is lower than **switchover_rpm_threshold**.

S RAMP

Controlled variation of an input using predefined acceleration and deceleration rate, using S ramp shape

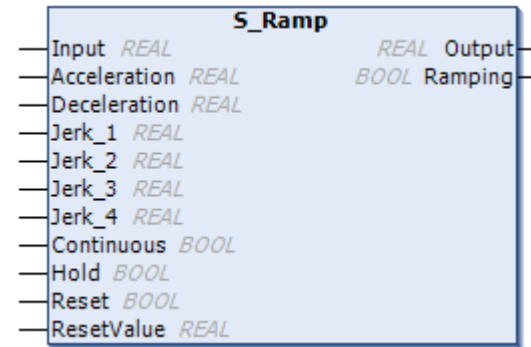
**Parameters**

Variable	Description
Input	Input to the ramp. Limited to between -100.0 and 100.0 %.
Acceleration	Acceleration rate in units of % per s ²
Deceleration	Deceleration rate in units of % per s ²
Jerk_1	Rate of change of acceleration part1
Jerk_2	Rate of change of acceleration part2
Jerk_3	Rate of change of acceleration part3
Jerk_4	Rate of change of acceleration part4
Continuous	When TRUE, forces a smooth transition if the ramp input is changed when ramping. The curve is controlled by the Acceleration and Jerk_1 to Jerk_4 parameters. When FALSE, there is an immediate transition from the old curve to the new curve.
Hold	When TRUE, the output of the ramp is held at its last value
Reset	When TRUE, Output = ResetValue
ResetValue	Value used for Output when Reset is TRUE.
Output	Output of the ramp.
Ramping	TRUE when ramping.

E-40 Library Function Blocks

Functional Description

The S-Ramp is like a linear ramp, but with smoothing applied at the transitions at the start and end of acceleration and at the start and end of deceleration. The degree of smoothing is defined by the Jerk_1 to Jerk_4 parameters, as shown below:

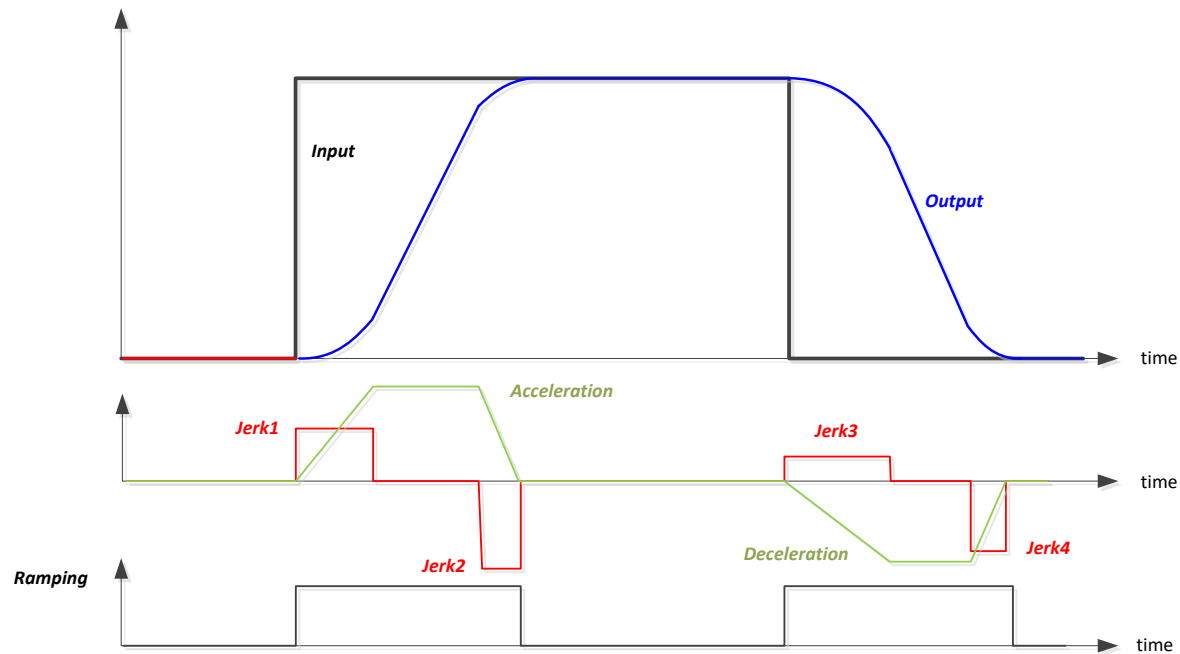

The time needed to stop or accelerate is

$$t = \frac{V}{A} + \frac{A}{J} \text{ [Seconds]}$$

If the speed profile is symmetrical, the average speed is $V/2$ therefore the stopping / acceleration distance can be calculated as:

$$s = \frac{V}{2} \left[\frac{V}{A} + \frac{A}{J} \right] \text{ [Meters]}$$

This holds true if **Jerk_1 = Jerk_2** for acceleration and **Jerk_3 = Jerk_4** for deceleration.

Where:

V is the maximum speed the drive must reach in %/s.

A is the maximum acceleration in %/s².

J is the maximum value for jerk, in %/s³.

TIME OF DAY SELECT

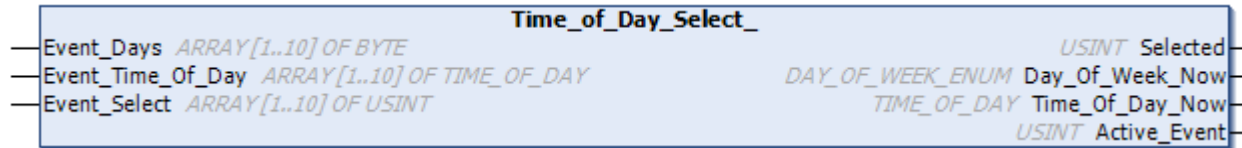

Parameters

Variable	Description																
Event_Days	<p>A bitmask indicating the valid days of the week for each of the ten possible events. Each element of Event_Days defines zero to seven days of the week when the corresponding event will be enabled. The bits correspond to days as follows:</p> <table border="1"> <thead> <tr> <th>Bit mask in binary</th> <th>Day of the week</th> </tr> </thead> <tbody> <tr> <td>00000001</td> <td>Sunday</td> </tr> <tr> <td>00000010</td> <td>Monday</td> </tr> <tr> <td>00000100</td> <td>Tuesday</td> </tr> <tr> <td>00001000</td> <td>Wednesday</td> </tr> <tr> <td>00010000</td> <td>Thursday</td> </tr> <tr> <td>00100000</td> <td>Friday</td> </tr> <tr> <td>01000000</td> <td>Saturday</td> </tr> </tbody> </table> <p>To activate an event for Monday thru Friday add the bit masks for each day, to give a binary bit mask of 00111110, (16#3E in hex or 62 in decimal).</p>	Bit mask in binary	Day of the week	00000001	Sunday	00000010	Monday	00000100	Tuesday	00001000	Wednesday	00010000	Thursday	00100000	Friday	01000000	Saturday
Bit mask in binary	Day of the week																
00000001	Sunday																
00000010	Monday																
00000100	Tuesday																
00001000	Wednesday																
00010000	Thursday																
00100000	Friday																
01000000	Saturday																
Event_Time_Of_Day	The time of day for each of the ten possible events.																
Event_Select	The value to output as Selected for each of the ten possible events.																
Selected	Value defined in Event_Select for the most recent event.																
Day_Of_Week_Now	<p>The day of week as an integer.</p> <ul style="list-style-type: none"> 0 Sunday 1 Monday 2 Tuesday 3 Wednesday 4 Thursday 5 Friday 6 Saturday 																
Time_Of_Day_Now	The time of day, 00:00:00 to 23:59:59																
Active_Event	The index of the most recent event, 1 to 10.																

E-42 Library Function Blocks

Functional Description

The function supports up to 10 events. Each event time is defined as a combination of the day of the week mask and the time of day. The time corresponding to an event is the start time. The event continues to be valid until another event becomes active. When an event has been detected, the **Selected** output is set to the value defined in **Event_Select** for that event index. The **Selected** output could be used together with the Presets2 block to select a speed setpoint dependent on the time of day and day of week.

For example, to achieve the Selected output at the time of day and day of week shown here, set configure the three input arrays as shown.

Day of week	Time of day	Selected
Monday thru Friday	06:30:00	1
Monday thru Friday	17:30:00	0
Saturday and Sunday	08:30:00	2
Saturday and Sunday	13:00:00	0

Index	Event_Days (in binary)	Event_Time_Of_Day	Event_Select
1	2#00111110	06:30:00	1
2	2#00111110	17:30:00	0
3	2#01000001	08:30:00	2
4	2#01000001	13:00:00	0
5	2#00000000	00:00:00	0
6	2#00000000	00:00:00	0
7	2#00000000	00:00:00	0
8	2#00000000	00:00:00	0
9	2#00000000	00:00:00	0
10	2#00000000	00:00:00	0

Setting the **Event_Days** entry for index 5 thru 10 to zero means that these events are ignored. Remember to define an end time for the “last” event in each day or week.

WELCOME SCREEN

The Welcome Screen function block may be used to define the text shown on the Welcome screen on the GKP.

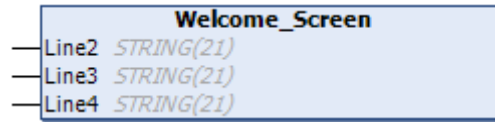
**Parameters**

Variable	Description
Line2	Define text for the second line shown on the GKP Welcome screen.
Line3	Define text for the third line shown on the GKP Welcome screen.
Line4	Define text for the fourth line shown on the GKP Welcome screen.

Functional Description

The GKP Welcome screen is typically of the form:

```
AC30 000D46001000
  3.5 A  400 V
    1.18.1
    192.168.1.50
```

The first line can be set via the parameter PNO 0961 Drive Name in the Drive Info block. By default, the second, third and fourth lines show the drive rating, firmware version and IP address. These three lines can instead be set to show arbitrary text defined by the Welcome_Screen block.

E-44 Library Function Blocks

WRITE DATA TO SD CARD

WRITE DATA TO SD CARD V2

The Write_Data_To_SD_Card block can be used to save data from the application to a file on the SD Card.

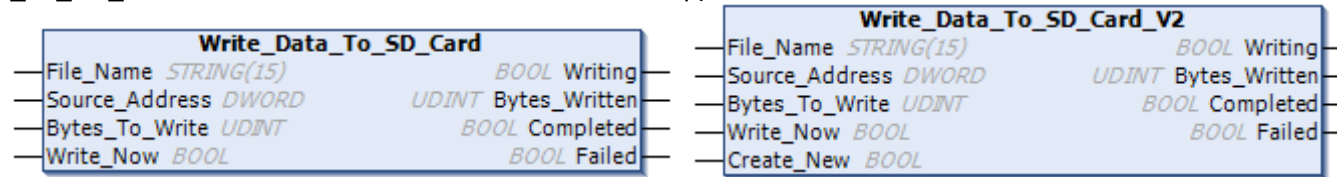

Parameters

Variable	Description
File_Name	The name of the file on the SD Card. The file must be in the root of the SD Card.
Source_Address	The address of the buffer from which the data is to be taken. This must be at least as long as Bytes_To_Write.
Bytes_To_Write	The number of bytes to add to the file.
Write_Now	Changing this value from FALSE to TRUE starts the write. Changing Write_Now to FALSE before the write is completed will abort the operation. Typically, Write_Now should be set back to FALSE only when the write is complete.
Create_New	Set TRUE before starting the write to force creation of a new file. If this parameter is FALSE then a new file will be created if File_Name does not exist on the SD Card. Otherwise the data will be appended to the end of the existing file.
Writing	Indicates that the write operation is in progress.
Bytes_Written	Indicates the number of bytes written. This parameter is only valid once the operation is completed.
Completed	Indicates that the write operation has finished.
Failed	When TRUE, indicates that the write attempt failed. This value is reset to FALSE when Write_Now is set back to FALSE.

Functional Description

This block is intended for applications that need to record data for future analysis. The feature is of especial interest for remote installations where such data cannot be extracted by a local supervisory system.

When designing the configuration, it should be noted that the write process can take 10s of milli-seconds. It is more efficient to occasionally write several hundred bytes of data than to frequently write a few tens of bytes. The write frequency needs to be balanced against the possibility of data loss due to a power failure.

ZERO SPEED

To detect if the speed is at or close to Zero, using threshold and hysteresis parameters

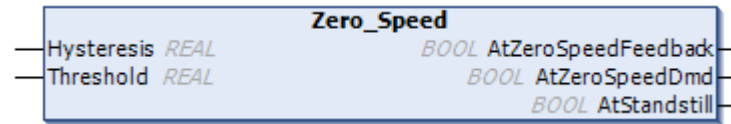
**Parameters**

Variable	Description
Hysteresis	Defines a hysteresis band about which the outputs are stable. If Hysteresis is \geq Threshold then the On level is set to 2 times Hysteresis and the Off level is set to zero. Otherwise the On level is (Threshold + Hysteresis) and the Off level is (Threshold – Hysteresis).
Threshold	The nominal level below which the outputs are set
AtZeroSpeedFeedback	TRUE when at zero speed, as defined by Threshold and Hysteresis .
AtZeroSpeedDmd	TRUE when the speed demand is zero, as defined by Threshold and Hysteresis .
AtStandstill	TRUE when both AtZeroSpeedFeedback and AtZeroSpeedDmd are TRUE.

E-46 Library Function Blocks

Functional Description

The outputs AtZeroSpeedFeedback and AtZeroSpeedDmd are set according to the rule:

- FALSE if $(\text{abs}(\text{speed feedback}) > \text{On level})$.
- TRUE if $(\text{abs}(\text{speed feedback}) \leq \text{Off level})$.
- If neither of the above conditions is met, then the output is unchanged.

The example below illustrates the behavior when **Hysteresis** is 0.2%.

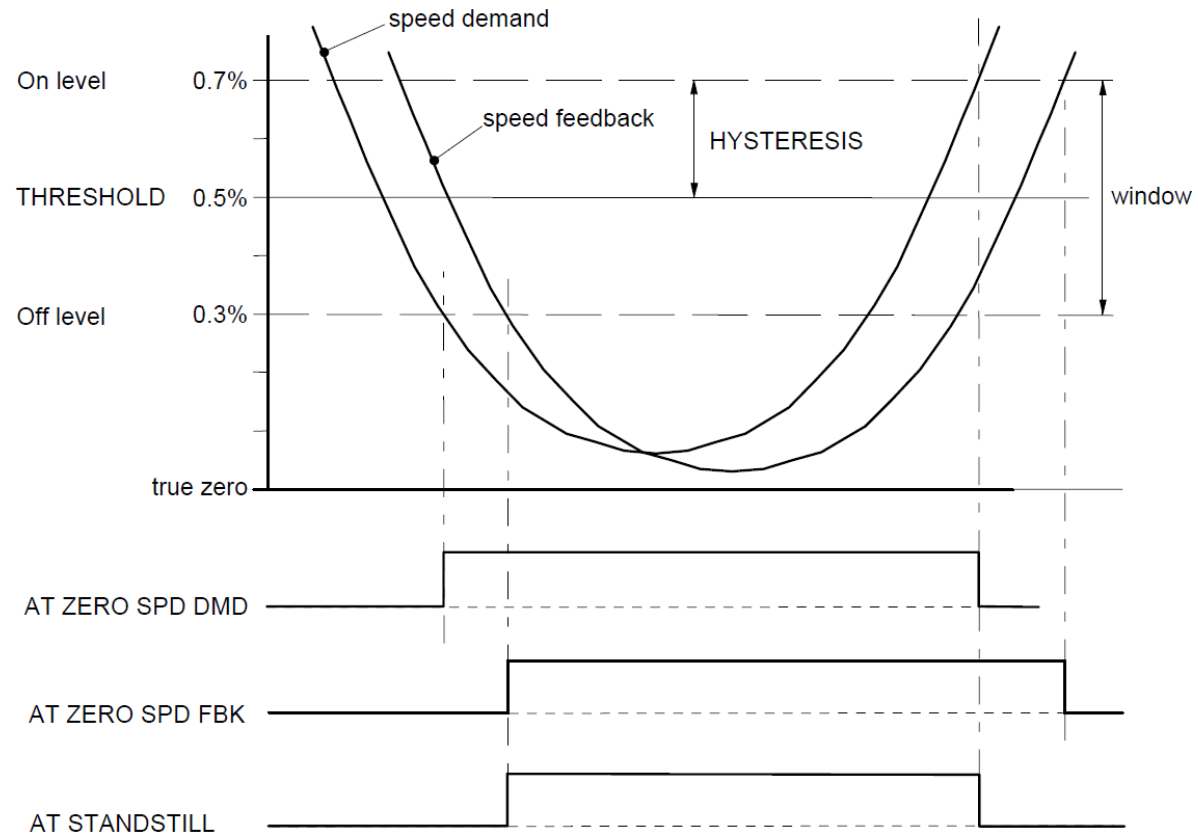

Index

0001	5-4, 6-4, C-94, C-230, C-232, C-266
0002	5-4, 6-4, C-94, C-95, C-232, C-266
0003	5-4, 6-4, C-95, C-232, C-266
0004	5-4, 6-4, C-96, C-232, C-266
0005	5-5, A-50, C-103, C-230, C-232, C-267
0006	C-97, C-103
0007	C-103
0008	C-103
0009	C-103
0010	C-103
0011	C-103
0012	C-103
0013	C-103
0014	C-103
0015	C-103
0016	C-103
0017	C-103
0018	C-103
0019	C-103
0020	C-103
0022	5-5, C-102, C-232, C-267
0023	C-102
0024	C-102
0025	C-102
0026	C-102
0027	C-102
0028	C-102
0031	C-102
0032	C-102
0033	C-102
0034	C-102
0037	C-102
0038	C-102
0039	5-5, C-94, C-104, C-233, C-266
0040	5-5, C-104, C-233, C-266
0041	5-5, C-95, C-104, C-233, C-266
0042	5-5, C-95, C-96, C-104, C-233, C-266
0043	5-5, C-96, C-104, C-233, C-266
0044	5-4, 6-6, 6-7, 7-13, C-233, C-267
0045	5-6, 7-16, C-233, C-267
0046	C-233, C-267
0047	5-6, C-233, C-267
0048	5-5, 6-6, 6-7, C-233, C-267
0049	5-6, C-233, C-267
0050	5-6, C-233, C-267
0051	5-6, C-233, C-267
0052	5-6, C-233, C-267
0053	5-6, C-233, C-267
0054	5-6, C-233, C-267
0055	5-5, C-233, C-269
0056	C-233, C-269
0114	8-31, C-234, C-268
0115	C-226, C-234, C-269
0116	C-226, C-234, C-269
0117	C-187, C-234, C-267
0118	C-14, C-234, C-267
0119	C-70, C-234, C-267
0120	5-5, C-234, C-270
0121	C-234, C-270
0123	A-3
0182	C-121, C-235, C-266
0183	C-121, C-235, C-266
0184	C-121, C-235, C-266
0185	C-235, C-267
0186	5-6, C-235, C-267
0187	C-235, C-267
0188	C-235, C-267
0189	5-6, C-235, C-268
0195	5-6, C-235, C-268
0196	5-6, C-235, C-268
0197	5-6, C-235, C-268
0198	5-6, C-235, C-268
0199	5-5, 6-7, C-235, C-266
0200	5-5, 6-7, C-235, C-267
0201	5-5, 6-7, C-235, C-267
0202	5-5, 6-7, C-235, C-267
0203	5-5, 6-7, C-235, C-268
0204	5-5, C-235, C-270
0205	5-5, C-235, C-268
0206	5-5, C-235, C-268
0207	5-5, C-235, C-268
0208	5-6, C-235, C-266
0209	5-4, C-235, C-266
0210	5-4, C-235, C-266
0211	5-6, C-235, C-267
0212	5-4, 6-6, C-235, C-267
0213	5-5, 6-6, C-235, C-267
0214	5-6, C-236, C-267
0215	5-5, C-236, C-267
0216	5-5, C-236, C-267
0217	5-5, C-236, C-267
0218	5-6, C-236, C-267
0219	5-5, 6-7, C-236, C-267
0220	5-5, 6-7, C-236, C-267
0221	5-6, C-236, C-267
0222	5-5, C-236, C-267
0223	5-5, C-236, C-267
0224	5-6, C-236, C-267
0225	5-6, C-236, C-267
0226	5-5, C-236, C-267
0227	5-5, C-236, C-267
0228	5-6, C-236, C-268
0229	5-5, 6-7, C-236, C-268
0230	5-5, 6-7, C-236, C-268
0231	5-5, 6-7, C-236, C-268
0232	5-5, 6-7, C-236, C-268
0233	5-5, 6-7, C-236, C-268
0234	5-6, C-236, C-268
0235	5-5, C-236, C-268
0236	5-5, C-236, C-268, C-271
0237	5-6, C-236, C-269
0238	5-5, 6-7, C-236, C-269
0239	5-6, C-237, C-269
0240	5-6, C-237, C-269
0249	C-27, C-237, C-266
0251	C-27, C-237, C-266
0252	C-27, C-237, C-266
0253	C-27, C-237, C-266
0254	C-27, C-237, C-266
0255	5-3, 6-8, C-21, C-237, C-266

2 Index

0256	5-3, C-21, C-237, C-266	0347	C-212, C-238, C-269	0412	C-21, C-122, C-238, C-270
0257	5-3, 7-11, C-21, C-237, C-266	0348	C-212, C-238, C-268	0413	C-122, C-238, C-269
0274	5-3, C-22, C-237, C-266	0349	C-212, C-238, C-268	0414	C-123, C-238, C-267
0286	C-237, C-268	0350	C-212, C-238, C-268	0415	C-217, C-238, C-269
0287	C-237, C-268	0351	C-212, C-238, C-268	0416	C-217, C-238, C-268
0289	C-237, C-268	0352	C-212, C-238, C-268	0417	5-3, C-217, C-238, C-268
0290	C-237, C-268	0353	C-213, C-238, C-268	0418	C-217, C-238, C-267
0291	C-237, C-268	0354	C-198, C-238, C-269	0419	C-217, C-238, C-270
0305	5-3, A-50, C-43, C-237, C-267	0356	C-198, C-238, C-269	0420	5-5, C-218, C-238, C-266
0307	C-43, C-237, C-269	0357	C-198, C-238, C-269	0421	5-5, C-218, C-239, C-266
0310	C-83, C-237, C-270	0360	C-197, C-238, C-269	0422	5-3, 6-6, C-78, C-239, C-270
0311	C-83, C-237, C-270	0361	C-197, C-238, C-269	0423	C-80, C-239, C-270
0312	C-83, C-237, C-267	0362	C-197, C-238, C-269	0424	C-239, C-270
0313	C-83, C-237, C-269	0364	C-48, C-210, C-238, C-270	0429	C-48
0314	C-83, C-237, C-269	0371	C-228, C-238, C-270	0435	C-80, C-239, C-270
0315	C-83, C-237, C-269	0374	C-228, C-238, C-268	0436	C-239, C-270
0316	C-84, C-237, C-269	0380	5-6, C-64, C-238, C-269	0447	5-3, C-78, C-239, C-267
0317	C-84, C-237, C-268	0381	5-6, C-64, C-238, C-269	0448	C-79, C-239, C-266
0318	C-10, C-84, C-237, C-258, C-267	0382	5-6, C-64, C-238, C-269	0450	C-79, C-239, C-266
0324	C-92, C-237, C-267	0383	5-6, C-64, C-238, C-251, C-267	0451	C-79, C-239, C-267
0325	C-92, C-237, C-267	0385	5-6, C-64, C-238, C-269	0453	C-80, C-239, C-270
0326	C-92, C-237, C-267	0386	C-64, C-238, C-269	0454	C-80, C-239, C-270
0327	C-92, C-237, C-267	0389	C-64, C-238, C-269	0455	5-3, 6-5, C-116, C-239, C-269
0328	C-92, C-237, C-267	0390	5-3, 6-6, C-69, C-213, C-238, C-267	0456	5-3, 6-5, C-58, C-116, C-239, C-266
0329	C-92, C-237, C-267	0392	5-5, 5-6, 7-15, C-69, C-238, C-267	0457	5-3, 6-5, C-58, C-116, C-239, C-266
0330	C-93, C-237, C-267	0393	5-5, C-26, C-69, C-238, C-251, C-261, C-266	0458	5-3, 6-5, C-116, C-239, C-268
0331	C-93, C-237, C-267	0394	5-5, C-70, C-238, C-266	0459	5-3, 6-5, C-58, C-116, C-239, C-268
0332	C-113, C-237, C-266	0395	5-5, A-5, A-13, A-15, A-19, A-31, A-35, A-37, A-54, C-70, C-234, C-238, C-251, C-263, C-266	0460	5-3, 6-5, C-117, C-239, C-268
0333	C-113, C-237, C-268	0396	5-5, C-70, C-238, C-267	0461	5-3, 6-5, C-117, C-239, C-269
0334	C-113, C-237, C-268	0397	C-48, C-70, C-238, C-268	0464	5-3, 6-6, 7-12, C-58, C-178, C-186, C-239, C-266, E-36
0335	C-114, C-237, C-268	0398	C-71, C-238, C-268	0465	C-239, C-270
0336	C-114, C-237, C-268	0399	5-5, C-71, C-238, C-266	0466	C-239, C-270
0337	C-114, C-237, C-268	0400	5-5, C-71, C-238, C-266	0467	C-134, C-239, C-269
0338	C-114, C-237, C-268	0401	5-5, C-71, C-238, C-268	0468	C-134, C-239, C-269
0339	C-237, C-266	0402	5-5, C-71, C-238, C-268	0469	C-134, C-239, C-269
0340	C-114, C-237, C-268	0403	C-71, C-238, C-266	0470	C-134, C-239, C-269
0341	C-114, C-238, C-268	0404	C-71, C-238, C-270	0476	C-134, C-239, C-269
0342	C-115, C-238, C-268	0405	5-5, C-48, C-71, C-238, C-268	0477	C-138, C-239, C-269
0343	C-211, C-238, C-266	0406	5-5, 7-15, C-72, C-238, C-267	0478	5-3, 6-5, C-138, C-239, C-269
0344	C-211, C-238, C-268	0407	5-5, 7-15, C-72, C-238, C-268	0479	5-3, 6-6, C-138, C-239, C-269
0345	C-211, C-238, C-268	0408	C-72, C-238, C-267	0484	5-3, 6-6, C-160, C-239, C-269
0346	C-212, C-238, C-269	0410	C-13, C-238, C-266	0485	C-161, C-239, C-269
				0486	5-3, 6-6, C-160, C-239, C-266

0487	5-3, 6-6, C-160, C-239, C-267
0488	C-161, C-239, C-270
0489	C-161, C-239, C-270
0490	C-161, C-240, C-270
0491	C-161, C-240, C-270
0492	C-161, C-240, C-270
0493	C-162, C-240, C-270
0494	C-162, C-240, C-270
0495	C-162, C-240, C-270
0496	C-162, C-240, C-270
0497	2-3, C-162, C-240, C-269
0498	C-162, C-240, C-269
0499	C-162, C-240, C-269
0500	C-163, C-240, C-269, E-3
0501	2-5, C-163, C-240, C-268
0502	C-163, C-240, C-268
0503	C-163, C-240, C-268
0504	5-3, C-163, C-240, C-270
0505	C-148, C-149, C-163, C-240, C-270
0506	C-163, C-240, C-270
0507	C-164, C-240, C-269
0508	C-164, C-240, C-269
0509	C-164, C-240, C-267
0511	5-3, 6-5, 7-16, C-38, C-240, C-268
0512	5-3, 6-5, 7-16, C-20, C-38, C-240, C-267
0513	5-6, C-224, C-240, C-266
0514	5-6, C-26, C-226, C-240, C-261, C-270
0515	C-205, C-240, C-270
0516	C-205, C-240, C-270
0517	C-205, C-240, C-270
0518	C-205, C-240, C-270
0519	C-205, C-240, C-269
0520	C-205, C-240, C-269
0521	C-206, C-240, C-269
0523	C-206, C-240, C-269
0524	C-206, C-240, C-269
0525	C-206, C-240, C-269
0526	C-206, C-240, C-269
0527	C-206, C-240, C-269
0528	C-202, C-240, C-267
0529	C-202, C-240, C-267
0530	C-202, C-240, C-267
0531	C-202, C-240, C-267
0533	C-203, C-240, C-270
0534	C-203, C-240, C-270
0535	C-203, C-240, C-270
0536	C-203, C-240, C-270
0543	C-58, C-240, C-269
0555	5-3, 6-5, C-20, C-129, C-130, C-241, C-268
0556	5-3, 6-5, C-20, C-129, C-130, C-241, C-268
0557	5-3, 6-5, C-20, C-130, C-241, C-269
0558	5-3, 6-5, C-20, C-130, C-241, C-269
0559	5-3, 6-5, C-20, C-130, C-241, C-269
0560	5-3, 6-5, C-130, C-241, C-268
0561	5-3, 6-5, C-131, C-241, C-269
0562	5-3, 6-5, C-21, C-131, C-241, C-269
0563	5-3, 6-5, C-131, C-241, C-269
0564	5-3, 6-5, C-20, C-131, C-241, C-269
0565	5-3, 6-5, C-131, C-241, C-269
0568	C-90, C-241, C-268
0569	C-90, C-241, C-269
0570	C-90, C-241, C-268
0571	C-90, C-91, C-241, C-270
0572	C-90, C-241, C-268
0591	C-188, C-241, C-268
0592	C-188, C-191, C-241, C-268
0610	2-3, 2-5, C-188, C-241, C-266, E-34
0627	A-5, A-13, A-15, A-19, A-31, A-35, A-37, A-54, 2-5, 2-6, C-189, C-233, C-241, C-262, C-267
0644	7-15, 2-5, C-19, C-189, C-242, C-267
0661	A-5, A-13, A-15, A-19, A-31, A-35, A-37, A-54, 2-6, C-18, C-190, C-234, C-242, C-263, C-270, E-34
0678	7-15, 2-1, C-190, C-242, C-269
0679	C-190, C-242, C-270
0680	C-190, C-191, C-242, C-266
0681	A-5, A-13, A-15, A-19, A-31, A-35, A-37, A-54, 2-5, 2-6, C-191, C-233, C-242, C-262, C-267
0682	C-191, C-242, C-269
0686	5-4, C-95, C-96, C-242, C-266
0687	C-57, C-243, C-266
0688	C-60, C-243, C-267
0689	C-127, C-243, C-268
0690	C-127, C-243, C-268
0691	C-127, C-243, C-268
0692	C-127, C-243, C-268
0693	C-127, C-243, C-268
0694	C-128, C-243, C-268
0695	C-59, C-243, C-266
0696	5-6, A-5, C-222, C-243, C-251, C-267
0697	A-8, C-223, C-243, C-267
0730	A-24, A-51, C-223, C-244, C-267
0763	5-6, C-224, C-245, C-266
0796	5-3, C-16, C-246, C-266
0829	5-6, C-26, C-225, C-226, C-246, C-261, C-270
0890	C-107, C-247, C-268
0891	C-107, C-247, C-268
0892	C-107, C-247, C-268
0893	C-107, C-247, C-266
0894	C-247, C-268
0895	C-221, C-247, C-251, C-269
0896	C-247, C-269
0906	C-214, C-247, C-270
0907	C-214, C-247, C-270
0908	C-200, C-247, C-267
0909	C-214, C-247, C-270
0910	C-214, C-247, C-270
0911	C-214, C-247, C-270
0912	C-227, C-247, C-270
0913	C-227, C-247, C-268
0914	C-227, C-247, C-270
0915	C-227, C-247, C-270
0916	C-227, C-247, C-270
0917	C-247, C-270
0918	C-227, C-247, C-267
0919	5-6, 8-3, 8-9, 8-12, C-247, C-267
0920	5-6, 8-9, 8-23, C-247, C-268
0926	5-6, 8-3, 8-9, A-12, A-34, C-247, C-251, C-268
0927	5-6, 8-3, 8-10, A-12, A-34, C-247, C-270
0928	5-6, 8-3, 8-10, 8-12, 8-19, A-12, A-34, C-247, C-268
0929	5-4, 6-8, 8-3, 8-4, 8-5, 8-7, 8-11, 8-12, A-12, A-34, C-247, C-267
0930	5-4, 6-8, 8-3, 8-4, 8-5, 8-6, 8-7, 8-11, A-12, A-34, C-247, C-266
0931	8-4, 8-10, 8-12, C-247, C-268
0933	5-4, 6-8, 8-4, 8-11, 8-12, A-12, A-34, C-247, C-270
0934	5-4, 6-8, 8-4, 8-11, 8-12, A-12, A-34, C-248, C-270
0935	5-4, 6-8, 8-4, 8-11, 8-12, A-12, A-34, C-248, C-270
0936	8-3, 8-11, C-248, C-268
0937	8-10, C-248, C-267

4 Index

- 0938 8-10, C-248, C-267
0939 5-4, 6-8, A-1, A-9, C-248, C-268
0940 5-4, 6-8, A-2, A-6, A-9, C-248, C-268
0941 5-4, 6-8, A-8, A-9, C-248, C-268
0942 5-4, 6-8, A-8, A-9, C-248, C-268
0943 5-6, A-8, A-9, C-248, C-269
0944 5-4, 5-5, 6-2, 8-15, 8-17, A-14, A-36, C-248, C-270
0945 8-3, 8-15, 8-17, C-248, C-270
0946 8-17, C-248, C-270
0951 C-57, C-248, C-266
0955 C-44, C-248, C-267
0957 5-4, C-94, C-248, C-266
0958 5-4, C-94, C-248, C-266
0959 5-4, C-95, C-248, C-266
0960 5-4, C-95, C-248, C-266
0961 5-5, 6-2, A-5, C-57, C-248, C-267, E-43
0968 C-221, C-248, C-270
0969 C-248, C-270
0972 C-221, C-248, C-270
0973 C-248, C-270
0976 6-5, C-57, C-58, C-248, C-268
0977 7-16, C-60, C-248, C-267
0982 5-5, C-87, C-248, C-270
0983 5-5, C-87, C-248, C-267
0987 7-12, C-57, C-58, C-248, C-269
0988 C-54, C-248, C-270
0989 C-31, C-54, C-248, C-266
0990 C-54, C-248, C-266
0991 C-54, C-248, C-266
0992 C-54, C-248, C-266
0993 C-54, C-249, C-267
0994 C-54, C-249, C-268
0995 C-54, C-249, C-267
0996 C-55, C-249, C-268
0997 C-55, C-249, C-267
0998 5-6, C-55, C-249, C-269
0999 5-6, C-55, C-249, C-269
100% Mot Current C-113, C-237, C-266
100% Speed in RPM 5-3, 6-6, 7-11, 7-12, C-43, C-58, C-70, C-138, C-169, C-170, C-178, C-186, C-203, C-239, C-266, E-36
100% Stack Current A C-71, C-238, C-266
100% Stk Current C-211, C-238, C-266
1000 6-2, 6-5, C-9, C-21, C-22, C-27, C-69, C-70, C-71, C-90, C-116, C-128, C-131, C-132, C-138, C-168, C-169, C-194, C-216, C-220, C-235, C-237, C-238, C-239, C-241, C-243, C-249, C-253, C-255, C-256, C-258, C-260, C-261, C-265, C-269, E-15, E-19, E-29
1001 7-9, C-53, C-249, C-269
1002 6-2, C-53, C-249, C-270
1003 7-9, C-249, C-269
1004 C-216, C-249, C-270
1005 4-8, 6-2, C-193, C-249, C-268
1006 6-2, 7-9, C-193, C-249, C-269
1033 C-187, C-249, C-267
1034 C-187, C-249, C-267
1038 C-187, C-249, C-267
1039 C-187, C-249, C-266
1040 C-13, C-249, C-269
1047 C-13, C-249, C-268
1048 C-13, C-249, C-268
1054 C-13, C-249, C-269
1061 C-13, C-249, C-269
1068 C-14, C-249, C-269
1089 5-6, C-249, C-266
1091 5-4, C-249, C-266
1092 5-4, C-249, C-266
1093 5-4, C-249, C-266
1094 5-4, C-249, C-266, C-271
1095 5-5, C-249, C-266
1096 5-5, C-249, C-266
1097 C-88, C-250, C-268
1098 C-88, C-250, C-268
1099 C-88, C-250, C-270
1100 C-57, C-250, C-267
1108 5-4, C-95, C-96, C-250, C-266
1109 C-59, C-250, C-270
1116 C-59, C-250, C-267
1121 C-60, C-250, C-267
1125 C-60, C-250, C-268
1129 C-60, C-250, C-267
1134 C-60, C-250, C-268
1139 C-172, C-250, C-267
1140 C-106, C-250, C-269
1141 6-2, C-87, C-250, C-270
1142 5-5, C-87, C-250, C-268
1143 C-88, C-250, C-270
1178 5-4, 6-4, 7-13, C-100, C-250, C-268, E-31
1179 7-16, C-100, C-250, C-268, E-31
1180 C-100, C-250, C-259, C-268
1181 5-5, C-85, C-250, C-266
1182 5-5, C-85, C-86, C-250, C-266
1183 5-5, C-85, C-86, C-250, C-266
1184 5-4, 6-4, C-216, C-250, C-270
1185 C-216, C-250, C-270
1186 6-2, C-49, C-166, C-250, C-270
1187 C-86, C-250, C-269
1188 C-200, C-250, C-267
1189 C-250, C-267
1200 7-9
1213 C-70, C-250, C-266
1214 C-117, C-251, C-266
1225 C-166, C-251, C-267
1228 C-166, C-251, C-270, C-272
1229 C-179, C-251, C-268
1230 C-179, C-251, C-268
1231 C-178, C-251, C-267
1232 C-179, C-251, C-267
1235 C-251, C-267
1239 C-106, C-251, C-268
1240 C-106, C-251, C-268
1241 5-6, A-8, A-9, C-251, C-268
1246 C-204, C-251, C-270
1247 C-204, C-251, C-269
1248 C-204, C-251, C-270
1251 5-6, C-251, C-267
1252 C-172, C-251, C-268
1253 C-89, C-106, C-251, C-268
1254 C-60, C-251, C-268
1255 C-89, C-106, C-251, C-268
1256 C-61, C-251, C-268
1257 5-3, 6-6, C-148, C-149, C-160, C-251, C-269
1258 C-59, C-251, C-270
1264 C-209, C-251, C-268
1265 C-209, C-251, C-268
1266 C-209, C-251, C-270, E-15
1267 C-209, C-251, C-270
1268 C-123, C-251, C-269

1269	8-10, C-251, C-267
1270	C-201, C-251, C-268
1271	C-251, C-252, C-268
1291	C-185, C-252, C-268
1292	C-185, C-252, C-268
1293	C-185, C-252, C-268
1294	C-96, C-252, C-267
1310	C-178, C-252, C-267
1311	7-10, C-200, C-252, C-269
1312	7-10, C-252, C-269
1313	7-10
1332	C-175, C-252, C-269
1333	C-175, C-252, C-269
1334	C-175, C-252, C-269, E-19
1335	C-98, C-252, C-253, C-267
1352	C-200, C-253, C-267
1353	C-253, C-267
1364	C-253, C-269
1365	C-174, C-253, C-269
1366	C-174, C-253, C-269
1367	C-174, C-253, C-269, C-271
1368	C-175, C-253, C-269
1369	C-175, C-253, C-269
1370	C-175, C-253, C-269
1371	C-175, C-253, C-269
1372	C-176, C-253, C-269
1373	C-176, C-253, C-269
1374	C-176, C-253, C-269
1375	C-176, C-253, C-269
1376	C-176, C-253, C-269
1386	8-19, C-253, C-269
1387	5-3, 6-5, C-20, C-132, C-253, C-268
1388	5-3, C-22, C-253, C-266
1405	5-3, C-22, C-253, C-266
1406	C-172, C-253, C-268
1407	C-172, C-253, C-268, E-19
1408	C-221, C-253, C-270
1441	5-4, C-96, C-254, C-266
1442	C-221, C-254, C-269
1443	C-254, C-269
1450	C-58, C-186
1458	A-8, A-10, C-254, C-268
1459	C-22, C-254, C-268
1460	5-4, C-96, C-254, C-266
1461	5-4, C-85, C-86, C-254, C-266
1462	5-4, C-85, C-254, C-266
1463	5-4, C-85, C-86, C-254, C-266
1464	5-4, C-85, C-254, C-266
1465	5-4, C-86, C-254, C-266
1466	5-4, C-86, C-254, C-266
1467	5-4, C-96, C-254, C-266
1468	5-4, C-96, C-254, C-266
1469	5-3, C-15, C-16, C-18, C-19, C-254, C-255, C-266
1470	5-3, C-15, C-18, C-19, C-254, C-266
1471	5-3, C-15, C-17, C-18, C-254, C-266
1472	5-3, C-16, C-254, C-266
1505	5-3, C-17, C-18, C-255, C-266
1506	5-3, C-17, C-18, C-255, C-266
1507	C-17, C-19, C-255, C-266
1508	C-18, C-19, C-255, C-266
1509	C-17, C-18, C-19, C-255, C-266
1510	C-18, C-255, C-266
1511	5-4, 6-4, C-62, C-63, C-255, C-267
1512	5-4, 6-4, C-62, C-255, C-267
1513	5-4, C-62, C-255, C-267
1514	5-4, 6-4, C-62, C-255, C-257, C-267
1515	5-4, 6-4, C-62, C-255, C-267
1516	5-5, C-63, C-255, C-267
1517	5-4, C-63, C-255, C-267
1518	5-5, C-63, C-255, C-267
1520	C-220, C-255, C-266
1521	C-220, C-255, C-270
1526	C-80, C-255, C-267
1527	C-220, C-255, C-268
1528	C-220, C-255, C-267
1529	C-220, C-255, C-270
1533	5-3, 6-5, 7-16, C-38, C-39, C-132, C-255, C-262, C-267
1534	5-5, C-30, C-31, C-32, C-255, C-267
1537	5-5, C-30, C-31, C-32, C-255, C-267
1538	5-5, C-31, C-32, C-255, C-268
1539	5-5, C-31, C-255, C-266
1540	5-5, C-31, C-32, C-255, C-268
1541	5-5, C-31, C-255, C-269
1542	5-5, C-32, C-255, C-267
1543	5-5, C-32, C-255, C-267
1544	C-75, C-256, C-267
1545	C-76, C-256, C-267
1546	C-76, C-256, C-268
1547	C-76, C-256, C-268
1548	C-76, C-256, C-267
1549	C-80, C-256, C-266
1550	5-3, C-21, C-256, C-268, C-271, C-272, C-273
1551	C-61, C-256, C-269
1554	C-14, C-256, C-266
1560	C-118, C-119, C-256, C-270, E-19
1565	C-188, C-256, C-268
1567	5-4, A-5, A-10, C-256, C-268
1568	C-256, C-268
1632	5-6, A-5, A-10, C-256, C-268
1633	C-80, C-256, C-266
1634	C-118, C-119, C-256, C-270
1635	C-118, C-119, C-256, C-267
1636	C-61, C-256, C-268
1637	C-88, C-256, C-267
1640	5-5, C-256, C-268
1641	C-51, C-256, C-270
1642	C-51, C-256, C-270
1643	C-51, C-256, C-270
1644	C-51, C-256, C-270
1645	C-150, C-256, C-269
1646	C-150, C-257, C-269
1647	C-150, C-257, C-269
1648	C-150, C-257, C-269
1649	C-151, C-257, C-269
1650	7-5, C-151, C-257, C-269
1651	C-151, C-257, C-269
1658	C-45, C-257, C-267
1659	5-4, A-6, A-10, C-257, C-268
1661	5-5, 8-21, 8-24, C-257, C-269
1663	5-4, C-180, C-181, C-257, C-267
1664	5-4, C-180, C-257, C-267
1665	5-4, C-180, C-257, C-267
1666	5-4, C-180, C-257, C-267
1667	5-4, C-180, C-257, C-268
1668	5-6, C-180, C-181, C-257, C-267
1669	5-4, C-181, C-257, C-267
1670	5-6, C-181, C-257, C-267
1671	5-4, C-182, C-257, C-267

6 Index

1672	5-4, C-182, C-257, C-267	1716	C-12, C-258, C-266	1780	C-259, C-269
1673	5-4, C-182, C-257, C-267	1717	C-11, C-258, C-266	1781	C-207, C-259, C-270
1674	5-4, C-182, C-257, C-268	1718	C-10, C-258, C-266	1782	8-10, C-259, C-268
1675	5-6, C-182, C-257, C-267	1721	5-6, C-12, C-258, C-266	1783	C-63, C-259, C-267
1676	5-4, C-182, C-257, C-267	1722	5-5, C-174, C-258, C-269	1784	C-259, C-267
1677	5-6, C-182, C-257, C-267	1723	5-6, C-174, C-258, C-269	1785	C-259, C-267
1678	5-4, C-183, C-184, C-257, C-258, C-268	1725	5-5, 8-28, 8-30, C-258, C-268	1787	5-5, 8-22, 8-24, C-259, C-269
1679	5-4, C-183, C-184, C-185, C-257, C-268	1726	5-5, 8-30, C-258, C-267	1788	8-19, C-259, C-269
1680	5-4, C-183, C-257, C-268	1727	5-5, 8-30, C-258, C-267	1789	8-19, C-259, C-269
1681	5-5, 8-22, 8-25, C-257, C-269	1728	5-5, 8-31, C-258, C-268	1790	5-4, 6-4, C-167, C-168, C-169, C-259, C-260, C-261, C-269
1682	C-257, C-269	1729	5-6, 8-31, C-258, C-268	1791	5-4, 6-4, C-167, C-260, C-269
1683	5-5, 8-24, C-257, C-269	1730	5-3, 6-6, C-9, C-258, C-266	1792	5-4, 6-4, C-167, C-260, C-269, C-271
1684	5-5, 8-19, 8-22, 8-24, C-257, C-269	1731	C-11, C-258, C-266	1793	5-4, 6-4, C-168, C-260, C-269
1685	5-5, 8-25, 8-27, C-257, C-269	1732	7-16, C-172, C-258, C-268	1794	C-89, C-260, C-269
1686	5-5, 8-23, 8-25, C-257, C-269	1733	C-172, C-173, C-258, C-270	1795	C-89, C-260, C-269
1687	5-6, 8-27, C-257, C-258, C-269	1734	C-17, C-258, C-266	1796	5-3, 7-6, C-142, C-143, C-144, C-260, C-266
1688	5-6, 8-21, 8-25, 8-27, C-257, C-269	1735	C-17, C-258, C-266	1797	5-3, C-143, C-260, C-266
1689	5-6, 8-26, C-257, C-269	1736	C-17, C-258, C-266	1798	5-3, C-142, C-260, C-266, C-272
1690	C-9, C-258, C-266	1737	C-17, C-258, C-266	1799	5-3, C-143, C-260, C-266
1691	C-10, C-258, C-266	1738	6-2, 8-15, C-192, C-258, C-267	1800	5-3, C-58, C-144, C-260, C-266
1692	C-12, C-258, C-266	1739	5-4, 7-13, C-215, C-258, C-259, C-270	1801	5-3, 7-10, C-144, C-260, C-266
1693	5-3, 6-6, C-9, C-10, C-258, C-266	1740	7-16, C-215, C-259, C-270	1802	C-144, C-260, C-266
1694	C-10, C-258, C-266	1741	C-215, C-259, C-270	1803	C-144, C-260, C-266
1695	C-10, C-258, C-266	1742	C-55, C-259, C-270	1804	C-132, C-144, C-260, C-266
1696	5-4, C-183, C-258, C-270	1743	5-3, 6-5, C-38, C-259, C-267	1805	C-145, C-260, C-266
1697	C-11, C-258, C-266	1744	C-35, C-259, C-269	1806	C-145, C-260, C-266
1698	5-4, C-183, C-258, C-270	1745	C-35, C-259, C-268	1807	7-6, C-146, C-260, C-266
1699	5-6, 8-27, C-258, C-269	1746	C-208, C-259, C-270	1808	5-3, 6-5, C-39, C-132, C-144, C-148, C-149, C-260, C-268
1701	C-119, C-120, C-258, C-270, E-38	1747	C-208, C-259, C-270	1809	5-3, 5-5, 6-5, C-132, C-142, C-145, C-147, C-148, C-149, C-260, C-269
1702	5-4, C-184, C-258, C-270	1748	C-208, C-259, C-270	1810	5-4, 6-4, C-168, C-260, C-269
1703	5-6, C-10, C-12, C-258, C-266	1749	C-35, C-259, C-269	1811	5-6, C-168, C-169, C-260, C-261, C-269
1704	5-4, 6-6, C-9, C-258, C-266	1750	C-36, C-58, C-259, C-267	1812	5-6, C-168, C-260, C-269
1705	5-4, 6-6, C-9, C-258, C-266	1751	C-36, C-37, C-259, C-268	1813	C-169, C-260, C-269
1706	C-9, C-258, C-266	1752	C-36, C-259, C-269	1814	5-6, C-169, C-260, C-269
1707	C-10, C-12, C-258, C-266	1753	C-37, C-259, C-269	1815	5-4, 6-4, C-168, C-260, C-269
1708	C-10, C-12, C-258, C-266	1754	C-68, C-77, C-259, C-268	1816	5-4, 6-4, C-169, C-170, C-260, C-261, C-269
1709	C-11, C-258, C-266	1756	5-4, C-184, C-259, C-268	1817	C-170, C-260, C-269
1710	C-11, C-258, C-266	1757	5-4, C-184, C-259, C-268	1818	C-170, C-260, C-269
1711	5-3, 6-6, C-10, C-258, C-266	1758	5-4, C-184, C-259, C-268	1819	C-170, C-260, C-269
1712	C-11, C-258, C-266	1759	5-5, C-174, C-259, C-269	1820	7-6, C-171, C-260, C-269
1713	C-11, C-258, C-266	1760	C-226, C-259, C-267		
1714	C-11, C-258, C-266	1762	C-216, C-259, C-270		
1715	C-12, C-258, C-266	1779	C-192, C-259, C-266		

- 1821 C-169, C-261, C-269
 1822 5-4, 6-4, C-168, C-261, C-269
 1823 C-169, C-261, C-269
 1824 5-6, C-168, C-261, C-269
 1825 5-4, 6-4, C-167, C-169, C-170, C-261, C-269
 1826 C-169, C-261, C-269
 1827 C-170, C-261, C-269
 1829 C-26, C-261, C-267
 1830 C-261, C-266
 1831 C-26, C-261, C-266
 1832 C-26
 1833 C-26
 1834 C-26
 1835 C-46, C-47, C-261, C-268
 1836 C-46, C-47, C-261, C-268
 1837 C-46, C-261, C-268
 1838 C-46, C-49, C-261, C-268
 1839 C-46, C-261, C-268
 1840 C-47, C-49, C-261, C-268
 1841 C-47, C-261, C-268
 1842 C-261, C-268
 1843 C-47, C-261, C-268
 1850 C-47
 1851 5-4, 6-4, C-169, C-261, C-269
 1852 C-26, C-261, C-267
 1853 5-5, C-261, C-267
 1854 C-261, C-270
 1855 C-181, C-261, C-267
 1856 C-261, C-267
 1857 C-261, C-267
 1858 C-261, C-268
 1859 C-261, C-268
 1861 C-192, C-261, C-269
 1862 C-105, C-261, C-268
 1863 C-105, C-261, C-269
 1865 C-105, C-261, C-267
 1866 C-105, C-261, C-268
 1867 C-105, C-261, C-269
 1868 C-46, C-261, C-268
 1869 C-57, C-58, C-261, C-266
 1870 C-184, C-185, C-261, C-270
 1871 C-185, C-261, C-270
 1872 C-184, C-185, C-261, C-270
 1874 C-177, C-179, C-261, C-262, C-267
 1875 C-177, C-261, C-267
 1876 C-177, C-262, C-267
 1877 C-177, C-262, C-267
 1878 C-177, C-178, C-262, C-267
 1879 C-178, C-262, C-267
 1885 C-39, C-262, C-270
 1886 C-39, C-262, C-266
 1887 C-39, C-262, C-270
 1891 8-20, C-262, C-269
 1892 C-177, C-262, C-267
 1893 C-178, C-262, C-267
 1894 C-179, C-262, C-268
 1895 C-262, C-266
 1896 C-262, C-266
 1897 C-262, C-266
 1898 C-178, C-262, C-268
 3000 5-4, A-13, A-31, A-35, A-54, C-186
 3064 5-4, A-13, A-31, A-35, A-54
 3128 5-4, 6-8, A-12, A-30, A-33, A-52
 3129 5-4, 6-8, A-24, A-30, A-51, A-52
 3130 5-6, A-12, A-13, A-25, A-30, A-33, A-35, A-53
 3131 5-6, A-25, A-31, A-53
 Absolute Calib Status C-262, C-266
 Acceleration Boost C-78, C-79, C-82, C-239, C-266
 Acceleration Time 5-3, 6-6, C-152, C-160, C-161, C-163, C-239, C-266, C-268, C-271, C-272, C-273
 Active 1 - 32 5-6, C-224, C-245, C-246, C-266
 Active 33 - 64 5-6, C-224, C-240, C-266
 Actual Control Type C-39, C-262, C-266
 Actual Field Current 5-5, C-71, C-82, C-238, C-266
 Actual Mot I2T Output C-237, C-266
 Actual Neg Torque Lim 5-5, C-217, C-218, C-239, C-266
 Actual Pos Torque Lim 5-5, C-217, C-218, C-238, C-266
 Actual Position C-70, C-250, C-266
 Actual Rotor T Const C-220, C-255, C-266
 Actual Speed Percent 5-5, A-5, A-13, A-15, A-19, A-23, A-35, A-37, C-70, C-238, C-266
 Actual Speed RPM 5-5, C-48, C-69, C-238, C-266
 Actual Speed rps 5-5, C-70, C-238, C-266
 Actual State C-54, C-248, C-266
 Actual Torque 5-5, C-71, C-130, C-238, C-266, E-3
 Address Assignment 5-5, 6-7, C-235, C-266
 AFE Brake Mode C-12, C-258, C-266
 AFE Close Ext PCR C-9, C-258, C-266
 AFE Correction Angle C-11, C-258, C-266
 AFE Current Control 5-3, 6-6, C-3, C-258, C-266
 AFE Enable Drive C-11, C-258, C-266
 AFE Ext PCR Closed C-10, C-258, C-266
 AFE Id Demand 5-4, 6-6, C-9, C-258, C-266
 AFE Inductance 5-3, 6-6, C-9, C-258, C-266
 AFE Iq Demand 5-4, 6-6, C-258, C-266
 AFE Max Current C-9, C-258, C-266
 AFE PF Angle Demand C-9, C-12, C-258, C-266
 AFE Phase Loss C-12, C-258, C-266
 AFE PLL Kp C-10, C-258, C-266
 AFE PLL Ti C-10, C-258, C-266
 AFE Status 5-6, C-12, C-258, C-266
 AFE Sync Angle C-10, C-258, C-266
 AFE Sync Frequency 5-6, C-10, C-258, C-266
 AFE Synchronized C-11, C-258, C-266
 AFE Synchronizing C-11, C-258, C-266
 AFE Transf Angle Offset C-11, C-258, C-266
 AFE VDC Demand 5-3, 6-6, C-4, C-10, C-258, C-266
 AFE VDC Feed Forward C-11, C-258, C-266
 AFE VDC Kp C-10, C-258, C-266
 AFE VDC Min Level C-4, C-11, C-258, C-266
 AFE VDC Ramp C-11, C-258, C-266
 AFE VDC Ti C-10, C-258, C-266
 Alignment Direction C-144, C-149, C-260, C-266
 Alignment Elec Pos C-144, C-260, C-266
 Alignment Enable 5-3, 6-12, C-142, C-145, C-147, C-260, C-266
 Alignment Ended C-145, C-147, C-260, C-266
 Alignment Error C-146, C-260, C-266
 Alignment Level 5-3, C-143, C-146, C-260, C-266
 Alignment Method 5-3, 6-12, C-142, C-145, C-147, C-148, C-149, C-260, C-266
 Alignment Offset C-144, C-148, C-149, C-260, C-266
 Alignment On Motor 5-3, C-143, C-144, C-147, C-260, C-266
 Alignment On Power On 5-3, C-142, C-143, C-260, C-266
 Alignment Ramp Time 5-3, C-144, C-260, C-266

8 Index

- Alignment State C-145, C-260, C-266
- Ambient Temperature C-107, C-247, C-266
- Anin 01 Break 5-5, C-104, C-233, C-266
- Anin 01 Offset 5-4, C-94, C-248, C-266
- Anin 01 Scale 5-4, C-94, C-248, C-266
- Anin 01 Type 5-4, 6-4, C-94, C-232, C-266
- Anin 01 Value 5-5, C-94, C-104, C-233, C-266
- Anin 02 Offset 5-4, C-95, C-248, C-266
- Anin 02 Scale 5-4, C-95, C-248, C-266
- Anin 02 Type 5-4, 6-4, C-94, C-95, C-232, C-266
- Anin 02 Value 5-5, C-95, C-104, C-233, C-266
- Anin 11 Offset 5-4, C-85, C-254, C-266
- Anin 11 Scale 5-4, C-85, C-254, C-266
- Anin 11 Value 5-5, C-85, C-250, C-266
- Anin 12 Offset 5-4, C-85, C-86, C-254, C-266
- Anin 12 Scale 5-4, C-85, C-254, C-266
- Anin 12 Value 5-5, C-85, C-86, C-250, C-266
- Anin 13 Offset 5-4, C-86, C-254, C-266
- Anin 13 Scale 5-4, C-86, C-254, C-266
- Anin 13 Value 5-5, C-85, C-86, C-250, C-266
- Anout 01 ABS 5-4, C-96, C-254, C-266
- Anout 01 Offset 5-4, C-95, C-96, C-250, C-266
- Anout 01 Scale 5-4, C-95, C-96, C-242, C-266
- Anout 01 Type 5-4, 6-4, C-95, C-232, C-266
- Anout 01 Value 5-5, C-95, C-96, C-104, C-233, C-266
- Anout 02 ABS 5-4, C-96, C-254, C-266
- Anout 02 Offset 5-4, C-96, C-254, C-266
- Anout 02 Scale 5-4, C-96, C-254, C-266
- Anout 02 Type 5-4, 6-4, C-96, C-232, C-266
- Anout 02 Value 5-5, C-96, C-104, C-233, C-266
- App Control Word 7-1, 2-3, 2-5, C-188, C-241, C-266, E-34
- App Reference C-190, C-191, C-242, C-266
- Application 4-9, 5-1, 5-3, 5-5, 6-3, 6-19, 7-2, 7-5, 7-6, 7-12, 7-13, 8-1, 2-2, 2-5, C-1, C-3, C-5, C-13, C-14, C-31, C-54, C-80, C-82, C-109, C-125, C-154, C-158, C-159, C-173, C-187, C-188, C-194, C-234, C-238, C-248, C-249, C-255, C-256, C-265, C-266, E-2, E-3, E-6, E-7, E-8
- Application XE "Application" Archive C-249
- Application Archive C-187
- Application Archive C-266
- Application XE "Application" FE State C-248
- Application FE State C-54
- Application FE State C-266
- Application XE "Application" Name C-256
- Application Name C-14
- Application Name C-266
- Application XE "Application" User Boost C-256
- Application User Boost C-80
- Application User Boost C-266
- Application XE "Application" Volts C-256
- Application Volts C-80, C-82
- Application Volts C-266
- AR Active C-17, C-19, C-255, C-266
- AR Enable 5-3, C-15, C-18, C-19, C-254, C-266
- AR Initial Delay 5-3, C-17, C-255, C-258, C-266
- AR Initial Delay XE "AR Initial Delay" B C-258
- AR Initial Delay B C-17
- AR Initial Delay B C-266
- AR Max Restarts 5-3, C-15, C-17, C-18, C-254, C-266
- AR Mode 5-3, C-15, C-18, C-19, C-254, C-266
- AR Repeat Delay 5-3, C-17, C-18, C-255, C-258, C-266
- AR Repeat Delay XE "AR Repeat Delay" B C-258
- AR Repeat Delay B C-17, C-18
- AR Repeat Delay B C-266
- AR Restart Pending C-18, C-19, C-255, C-266
- AR Restarts Remaining C-17, C-18, C-255, C-266
- AR Time Remaining C-18, C-255, C-266
- AR Trip Mask 5-3, C-16, C-17, C-18, C-246, C-254, C-255, C-258, C-266
- AR Trip Mask XE "AR Trip Mask" 2 C-246
- AR Trip Mask 2 5-3, C-16, C-17
- AR Trip Mask 2 C-258
- AR Trip Mask 2 C-266
- AR Trip Mask 2 C-266
- AR Trip Mask XE "AR Trip Mask" 2 XE "AR Trip Mask 2" B C-258
- AR Trip Mask 2 B C-17
- AR Trip Mask 2 B C-266
- AR Trip Mask XE "AR Trip Mask" B C-258
- AR Trip Mask B C-17
- AR Trip Mask B C-266
- Archive Flags C-13, C-238, C-266
- ATN PMAC Ls Test Freq 5-3, C-22, C-253, C-266
- ATN PMAC Test Disable 5-3, C-22, C-253, C-266
- Attached to Stack C-59, C-243, C-266
- Auto Boost C-78, C-79, C-82, C-239, C-266
- Auto Defaults C-57, C-58, C-261, C-266
- Auto Hide C-192, C-259, C-266
- Auto IP 5-4, 6-8, 8-3, 8-4, 8-5, 8-6, 8-7, 8-10, 8-11, A-12, A-34, C-247, C-266, C-268
- Automatic Pole Pairs C-117, C-251, C-266
- Autotune Enable 5-3, 6-8, C-21, C-23, C-237, C-266
- Autotune Mode 5-3, C-21, C-237, C-266
- Autotune Ramp Time 5-3, C-22, C-237, C-266, C-271, C-272, C-273
- Autotune Test Disable 5-3, 7-11, C-21, C-237, C-266
- Backup Action C-121, C-235, C-266
- Backup-Restore Start C-121, C-235, C-266
- Backup-Restore Status C-121, C-235, C-266
- BACnet Baud Rate 5-4, C-249, C-266
- BACnet IP Device ID 5-4, C-235, C-266
- BACnet IP State 5-6, C-235, C-266
- BACnet IP Timeout 5-4, C-235, C-266
- BACnet MAC Address 5-4, C-249, C-266
- BACnet Max Info Frames 5-5, C-249, C-266
- BACnet Max Master 5-5, C-249, C-266
- BACnet MSTP Device ID 5-4, C-249, C-266
- BACnet MSTP State 5-6, C-249, C-266
- BACnet MSTP Timeout 5-4, C-249, C-266
- Base Frequency 5-3, 6-5, 7-11, C-58, C-78, C-82, C-116, C-239, C-266
- Base IO FE State C-54, C-248, C-266
- Base Voltage 5-3, 6-5, C-58, C-116, C-239, C-266
- Basic Drive FE State C-54, C-248, C-266
- Black Box PNOs C-26, C-261, C-266
- Black Box PNOs[x] C-266
- Boot Version C-57, C-243, C-248, C-266
- Boot Version XE "Boot Version" Number C-243
- Boot Version Number C-57
- Boot Version Number C-266
- Brake Overrating 7-4, C-27, C-28, C-237, C-266
- Brake Rated Power C-27, C-28, C-237, C-266, C-271, C-272, C-273
- Brake Resistance C-27, C-237, C-266, C-271, C-272, C-273
- Braking Active C-27, C-237, C-266
- Braking Enable C-27, C-237, C-266

- Calib Fail Retry C-262, C-266
 Calibration Error C-262, C-266
 CANopen Actual Baud 5-6, C-251, C-267
 CANopen Baud Rate 5-5, 6-6, C-235, C-267
 CANopen Node Address 5-4, 6-6, C-235, C-267
 CANopen State 5-6, C-235, C-267
 Card Name C-187, C-249, C-267
 Card State C-187, C-249, C-267
 Clone Direction 5-5, C-30, C-31, C-32, C-255, C-267
 Clone Filename 5-5, C-30, C-255, C-267
 Clone Start 5-5, C-32, C-255, C-267
 Clone Status 5-5, C-32, C-255, C-267
 CM Temperature 5-5, 7-15, C-48, C-72, C-238, C-267
 CNet Consuming Inst 5-5, C-236, C-267
 CNet Producing Inst 5-5, C-236, C-267
 Comms Control Word 7-1, A-5, A-13, A-15, A-19, A-23, A-35, A-37, 2-5, 2-6, C-189, C-241, C-242, C-267
 Comms Diagnostic 5-6, C-233, C-267
 Comms Diagnostic XE "Comms Diagnostic" Code C-233
 Comms Diagnostic Code 5-6
 Comms Diagnostic Code C-267
 Comms Event Active 5-6, C-235, C-267
 Comms Event Clear C-235, C-267
 Comms Event Code C-235, C-267
 Comms Event Set C-235, C-267
 Comms Exception 5-6, C-233, C-267
 Comms Fitted 5-6, 7-16, C-233, C-267
 Comms Module Serial 5-6, C-233, C-267
 Comms Module Version 5-6, C-233, C-267
 Comms Net Exception 5-6, C-233, C-267
 Comms Option FE State C-54, C-249, C-267
 Comms Option Pcode C-60, C-250, C-267
 Comms Option Serial C-60, C-250, C-267
 Comms Reference A-5, A-13, A-15, A-19, A-23, A-35, A-37, 2-5, 2-6, C-191, C-242, C-267
 Comms Required 5-4, 6-6, 6-7, 7-6, 7-13, C-233, C-267
 Comms Reset Allow 5-5, C-261, C-267
 Comms State C-233, C-267
 Comms Supervised 5-6, C-233, C-267
 Comms Trip Enable 5-5, 6-6, 6-7, C-233, C-267
 Config Fault Area C-55, C-249, C-267
 Configuration Lock C-14, C-234, C-267
 Control Board Up Time C-172, C-173, C-221, C-250, C-267
 Control Module Pcode C-59, C-250, C-267
 Control Module Serial 7-16, C-60, C-248, C-267
 Control Screen 5-1, 5-2, 5-3, C-2, C-87, C-88, C-200, C-201, C-247, C-253, C-267
 Control Screen XE "Control Screen" Mode C-247
 Control Screen Mode C-200
 Control Screen Mode C-267
 Control Screen[x] C-267
 Control Strategy 5-3, 6-5, 6-20, 6-22, C-20, C-38, C-69, C-70, C-240, C-267
 Control Type 5-3, 6-5, 7-16, C-38, C-39, C-132, C-142, C-255, C-266, C-267
 Control Word 7-15, 2-3, A-5, A-13, A-15, A-19, A-23, A-35, A-37, 2-1, 2-3, 2-5, 2-6, C-19, C-188, C-189, C-242, C-266, C-267
 ControlNet MAC ID 5-5, C-236, C-267
 ControlNet State 5-6, C-236, C-267
 Copy Status C-26, C-261, C-267
 Copy to SD Card C-26, C-261, C-267
 Current Diff Level C-45, C-257, C-267
 Current Limit 5-3, A-50, C-1, C-8, C-43, C-92, C-213, C-214, C-237, C-267, C-269
 Cut Off Frequency C-75, C-76, C-256, C-267
 DC Current Level C-92, C-237, C-267, C-271, C-272, C-273
 DC Inj Base Volts C-93, C-237, C-267, C-271, C-272, C-273
 DC Inj Current Limit C-92, C-237, C-267
 DC Inj Deflux Time C-92, C-237, C-267, C-271, C-272, C-273
 DC Inj Frequency C-92, C-237, C-267, C-271, C-272, C-273
 DC Inj Timeout C-93, C-237, C-267
 DC Link Volt Filtered 5-5, C-70, C-238, C-267
 DC Link Voltage 5-5, 5-6, 7-15, C-48, C-69, C-190, C-238, C-267
 DC Link Volts Trim C-70, C-234, C-267
 DC Pulse Time C-92, C-237, C-267, C-271, C-272, C-273
 Deceleration Time 5-3, 6-6, C-152, C-160, C-161, C-163, C-239, C-267, C-268, C-271, C-272, C-273
 Deflux Delay C-123, C-238, C-267, C-271, C-272, C-273
 Delay To Start C-118, C-256, C-267
 Demanded Terminal Volts C-220, C-255, C-267
 Destination IP Address 5-5, 8-30, C-258, C-267
 Destination Port 5-5, 7-6, 8-30, 8-31, C-258, C-267
 DeviceNet Actual Baud 5-6, C-236, C-267
 DeviceNet Baud Rate 5-5, 6-7, C-236, C-267
 DeviceNet MAC ID 5-5, 6-7, C-236, C-267
 DeviceNet State 5-6, C-236, C-267
 DHCP 5-4, 6-8, 8-3, 8-4, 8-5, 8-7, 8-9, 8-10, 8-11, 8-12, 8-14, A-12, A-26, A-28, A-34, C-235, C-247, C-251, C-267, C-268
 DHCP XE "DHCP" State C-251
 DHCP State 8-10
 DHCP State C-267
 Digin Invert C-96, C-252, C-267
 Digin Value 5-5, A-50, C-103, C-232, C-267
 Digout Invert C-98, C-252, C-253, C-267
 Digout Value 5-5, C-102, C-232, C-267
 Direct Input Neg Lim C-202, C-240, C-267
 Direct Input Pos Lim C-202, C-240, C-267
 Direct Input Ratio C-202, C-240, C-267
 Direct Input Select C-202, C-240, C-267
 Disable Keys C-105, C-261, C-267
 Display Timeout 5-5, C-87, C-248, C-267
 Display Warnings C-226, C-259, C-267
 DNet Consuming Inst 5-5, C-236, C-267
 DNet Producing Inst 5-5, C-236, C-267
 Drive Diagnostic C-60, C-243, C-267
 Drive Name 5-5, 6-2, A-5, C-57, C-248, C-267, E-43
 DST Active 8-19, C-166, C-251, C-267
 Duty Selection 5-3, 6-6, C-69, C-213, C-238, C-267
 Elec Rotor Speed C-72, C-238, C-267
 Enable 1 - 32 C-223, C-243, C-244, C-267
 Enable 33 - 64 C-223, C-244, C-245, C-267
 Enable Auto Save 6-2, 8-15, C-57, C-58, C-192, C-258, C-267
 Enable Predict Term C-44, C-248, C-267
 Enc To Mot Shaft Ratio C-178, C-251, C-267
 Encoder Count 5-4, 5-5, 5-6, C-63, C-178, C-179, C-181, C-182, C-255, C-257, C-259, C-262, C-267, C-270
 Encoder Count XE "Encoder Count" Init C-259
 Encoder Count Init C-63
 Encoder Count Init C-267

10 Index

- Encoder Count Init C-267
- Encoder Count Init C-267
- Encoder Count XE "Encoder Count" Reset C-255, C-257
- Encoder Count Reset 5-4, C-63, C-181, C-182
- Encoder Count Reset C-267
- Encoder Count Reset C-267
- Encoder Count Reset C-267
- Encoder Feedback 5-3, 6-5, 6-10, 7-13, C-38, C-39, C-40, C-259, C-267
- Encoder Invert 5-4, C-62, C-147, C-177, C-180, C-182, C-184, C-255, C-257, C-262, C-267, C-270
- Encoder Lines 5-4, 6-4, C-62, C-177, C-179, C-180, C-182, C-183, C-255, C-257, C-262, C-267, C-270
- Encoder Position C-178, C-252, C-267
- Encoder Rev Count C-178, C-179, C-262, C-267
- Encoder Single Ended 5-4, 6-4, C-62, C-255, C-267
- Encoder Speed 5-5, 5-6, C-63, C-177, C-178, C-180, C-181, C-182, C-183, C-255, C-257, C-261, C-262, C-267, C-270
- Encoder Speed XE "Encoder Speed" Percent C-261, C-262
- Encoder Speed Percent C-178, C-181
- Encoder Speed Percent C-267
- Encoder Speed Percent C-267
- Encoder Speed Percent C-267
- Encoder Speed Percent C-267
- Encoder Status C-179, C-251, C-267
- Encoder Supply 5-4, 6-4, C-62, C-177, C-180, C-255, C-257, C-261, C-267
- Encoder Type 5-4, 6-4, C-62, C-177, C-180, C-182, C-255, C-257, C-261, C-267
- Endat Comms Status C-251, C-267
- Energy kWh 5-6, C-64, C-238, C-267
- Energy Saving Enable C-79, C-239, C-267
- Energy Saving Lower Lim C-80, C-255, C-267
- ENet Consuming Inst 5-5, C-236, C-267
- ENet Producing Inst 5-5, C-236, C-267
- Engineer Password C-88, C-256, C-267
- Error Number 7-6, C-36, C-259, C-267
- EtherCAT State 5-6, C-236, C-267
- Ethernet Diagnostic 8-10, C-248, C-267
- Ethernet FE State C-54, C-249, C-267
- EtherNet IP Diag A-25, A-31, A-53
- EtherNet IP Enable 6-8, A-12, A-30, A-33, A-52
- EtherNet IP State 5-6, A-12, A-13, A-25, A-30, A-33, A-35, A-53, C-236, C-263, C-267
- EtherNet IP Trip 6-8, A-24, A-30, A-51, A-52
- Ethernet State 5-6, 8-3, 8-9, 8-12, C-247, C-267
- Extended Support C-187, C-234, C-267
- Factor C-64, C-75, C-76, C-117, C-256, C-267, C-269, C-271, C-272, C-273
- Fast Stop Torque Lim C-217, C-238, C-267
- Favourites 4-3, 4-6, 5-1, 5-2, 5-6, C-87, C-88, C-200, C-201, C-250, C-267
- Favourites[x] C-267
- Filter Type C-75, C-76, C-256, C-267
- Filtered VDC Ripple C-227, C-247, C-267
- Final DC Pulse Time C-92, C-237, C-267, C-271, C-272, C-273
- Final Stop Rate C-164, C-240, C-267
- Firmware 4-10, 7-17, A-11, A-32, C-53, C-57, C-187, C-232, C-249, C-250, C-264, C-267, C-270
- Firmware XE "Firmware" Version C-250
- Firmware Version C-57
- Firmware Version C-267
- First Trip 5-6, A-5, C-221, C-222, C-243, C-267
- Fixed Boost 5-3, C-78, C-79, C-82, C-239, C-267
- Fixed Gateway Address 5-5, 6-7, C-235, C-267
- Fixed IP Address 5-5, 6-7, C-235, C-267
- Fixed Subnet Mask 5-5, 6-7, C-235, C-267
- Flying Reflux Time C-84, C-237, C-267, C-271, C-272, C-273
- Flying Start Mode C-83, C-237, C-267
- Free Packets 8-10, C-248, C-267
- Free Sockets 8-10, C-259, C-268
- Free Space (kBytes) C-77, C-259, C-268
- Frequency 1 C-75, C-76, C-194, C-256, C-265, C-268
- Frequency 2 C-75, C-76, C-194, C-256, C-265, C-268
- Full Restore 5-5, C-31, C-32, C-255, C-268
- Gateway Address 5-6, 8-3, 8-4, 8-10, 8-11, 8-12, 8-19, A-12, A-28, A-34, C-247, C-267, C-268, C-270
- GKP Password 5-5, C-87, C-88, C-250, C-268
- Green LED Force On C-105, C-261, C-268
- Group IP Address 8-30, 8-31, C-234, C-268
- Heatsink Temperature 5-5, 7-15, C-48, C-72, C-238, C-268
- High Input Threshold 5-4, C-180, C-182, C-257, C-268
- High Word First 5-4, 5-5, 6-7, 6-8, A-2, A-6, A-9, C-236, C-248, C-268
- High Word First XE "High Word First" RTU C-236
- High Word First RTU 5-5, 6-7
- High Word First RTU C-268
- High Word First XE "High Word First" TCP C-236
- High Word First TCP 5-5
- High Word First TCP C-268
- HV Power On Count C-172, C-253, C-268
- HV SMPS Up Time C-172, C-173, C-221, C-251, C-268
- id C-70, C-238, C-268
- IDE Version C-13, C-249, C-268
- IM Wiring C-247, C-268
- Input Mapping 5-4, A-13, A-15, A-19, A-31, A-35, A-37, A-54
- Inv Time Active C-114, C-211, C-213, C-238, C-268
- Inv Time Aiming Point C-212, C-238, C-268
- Inv Time Down Rate C-211, C-212, C-238, C-268
- Inv Time Output C-114, C-212, C-238, C-268
- Inv Time Up Rate C-211, C-212, C-238, C-268
- Inv Time Warning C-114, C-212, C-238, C-268
- IO Option FE State C-55, C-249, C-268
- IO Option Pcode C-60, C-250, C-268
- IO Option Serial No C-60, C-250, C-268
- IO Option SW Version C-60, C-251, C-268
- IP Address 4-5, 5-6, 8-3, 8-4, 8-6, 8-7, 8-9, 8-11, 8-12, 8-30, A-12, A-28, A-34, C-247, C-267, C-268, C-270
- IPConfig Enable 5-5, C-235, C-268
- iq C-71, C-238, C-268
- Jog Acceleration Time C-163, C-240, C-268
- Jog Deceleration Time C-163, C-240, C-268
- Jog Setpoint 2-5, C-106, C-163, C-240, C-268
- Key Press C-105, C-261, C-268
- Keypad FE State C-54, C-249, C-268
- Language 4-8, 6-2, C-193, C-249, C-268, E-8
- Last Auto IP Address 8-4, 8-10, C-247, C-268
- Last Modification C-13, C-249, C-268
- Leakage Inductance C-21, C-22, C-90, C-116, C-237, C-241, C-253, C-268
- Limit Log File Size C-47, C-49, C-261, C-268

- Local 4-3, 4-5, 4-6, 5-2, 5-5, 7-4, 7-12, 8-7, 8-30, 8-31, 2-1, A-32, A-34, C-1, C-88, C-89, C-106, C-188, C-191, C-209, C-241, C-250, C-251, C-256, C-258, C-268, C-269, C-270
- Local XE "Local" Dir Key Active C-251
- Local Dir Key Active C-89, C-106
- Local Dir Key Active C-268
- Local XE "Local" Port 8-30, C-258
- Local Port 5-5
- Local Port 8-31
- Local Port C-268
- Local XE "Local" Power Up Mode C-256
- Local Power Up Mode C-188
- Local Power Up Mode C-268
- Local XE "Local" Reference C-241
- Local Reference C-106, C-188, C-191
- Local Reference C-268
- Local XE "Local" Reverse C-251
- Local Reverse C-106
- Local Reverse C-268
- Local XE "Local" Run Key Active C-251
- Local Run Key Active C-106
- Local Run Key Active C-268
- Local/ XE "Local" Rem Key Active C-251
- Local/Rem Key Active C-89, C-106
- Local/Rem Key Active C-268
- Lock 4-6, 8-3, 8-11, 8-25, C-14, C-248, C-267, C-268, C-269
- Log Enable C-46, C-47, C-49, C-261, C-268
- Log File Name C-46, C-261, C-268
- Log File Size C-47, C-49, C-261, C-268
- Log New File On Reset C-46, C-261, C-268
- Log Now C-46, C-261, C-268
- Log Parameters C-47, C-261, C-268
- Log Parameters[x] C-268
- Log Period C-46, C-261, C-268
- Log to New File C-46, C-49, C-261, C-268
- Long Overload Level C-211, C-238, C-268
- Long Overload Time C-211, C-238, C-268
- MAC Address 5-6, 8-3, 8-9, 8-23, C-247, C-266, C-268
- Magnetising Current C-21, C-90, C-116, C-237, C-241, C-268
- Main Torque Lim 5-3, C-217, C-238, C-268
- Maintenance Reporting C-107, C-247, C-268
- Maintenance Reset C-107, C-108, C-247, C-268
- Maintenance Warnings C-107, C-108, C-247, C-268
- Manufacturing Flags C-61, C-256, C-268
- Mapping Valid 5-6, A-5, A-10, C-256, C-268
- Master Encoder C-36, C-259, C-268
- Master Position Src C-35, C-259, C-268
- Max Available Volts C-220, C-255, C-268
- Max Phase C-261, C-268
- Max Spd when Autotuned C-22, C-254, C-268
- Max Speed Clamp C-209, C-251, C-268
- Max VDC Ripple C-227, C-247, C-268, C-271, C-272, C-273
- Maximum Connections 5-4, 6-8, A-1, A-9, C-248, C-268
- Mechanical Offset C-179, C-251, C-268
- Min Search Speed C-84, C-237, C-268
- Min Speed Clamp C-209, C-251, C-268
- Modbus Conn Timeout A-8, A-10, C-254, C-268
- Modbus Device Address 5-5, 6-7, C-236, C-268
- Modbus Mapping 5-4, A-5, A-10, C-256, C-268
- Modbus Mapping[x] C-268
- Modbus Password 5-5, C-256, C-268
- Modbus RTU Baud Rate 5-5, 6-7, C-236, C-268
- Modbus RTU State 5-6, C-236, C-268
- Modbus RTU Timeout 5-5, 6-7, C-236, C-268
- Modbus TCP Password 5-4, A-6, A-10, C-257, C-268
- Modbus TCP State 5-6, C-236, C-268
- Modbus TCP Timeout 5-5, C-236, C-268
- Modbus Timeout 5-4, 6-8, A-8, A-9, C-248, C-268
- Modbus Trip Enable 5-4, 6-8, A-8, A-9, C-248, C-268
- Monitor 5-1, 5-2, 5-5, 6-26, 8-9, 8-10, 8-26, 8-27, 8-31, A-9, A-10, A-30, A-31, A-52, A-53, C-1, C-2, C-10, C-24, C-25, C-29, C-34, C-39, C-42, C-55, C-56, C-62, C-63, C-64, C-66, C-67, C-69, C-85, C-87, C-102, C-103, C-107, C-110, C-111, C-112, C-124, C-125, C-132, C-153, C-154, C-156, C-157, C-158, C-159, C-168, C-174, C-177, C-178, C-180, C-182, C-189, C-191, C-201, C-218, C-222, C-224, C-225, C-232, C-233, C-235, C-236, C-237, C-238, C-240, C-243, C-245, C-246, C-247, C-248, C-249, C-250, C-251, C-252, C-253, C-255, C-256, C-257, C-258, C-259, C-260, C-261, C-262, C-263, C-265, C-266, C-268, E-5
- Monitor[x] C-268
- Mot I2T Active C-114, C-237, C-268
- Mot I2T Enable C-115, C-238, C-268
- Mot I2T TC C-114, C-237, C-268
- Mot I2T Warning C-114, C-238, C-268
- Mot Inv Time Active C-114, C-237, C-268
- Mot Inv Time Delay C-113, C-237, C-268
- Mot Inv Time Output % C-114, C-237, C-268
- Mot Inv Time Overload C-113, C-237, C-268
- Mot Inv Time Warning C-114, C-237, C-268
- Motor Base Volts C-228, C-238, C-268
- Motor Count C-178, C-179, C-262, C-268
- Motor Count XE "Motor Count" Reset C-262
- Motor Count Reset C-179
- Motor Count Reset C-268
- Motor Current 5-5, C-43, C-71, C-116, C-130, C-238, C-268, C-269, C-271, C-272, C-273
- Motor Current XE "Motor Current" Percent C-238
- Motor Current Percent 5-5, C-71, C-130
- Motor Current Percent C-268
- Motor Poles 5-3, 6-5, C-20, C-116, C-117, C-130, C-239, C-268, C-269
- Motor Position C-179, C-251, C-268
- Motor Power 5-3, 6-5, C-117, C-239, C-268, C-271, C-272, C-273
- Motor Run Time C-172, C-253, C-268
- Motor Start Count 7-16, C-172, C-258, C-268
- Motor Terminal Volts 5-5, C-71, C-238, C-268
- Motor Type or AFE 5-3, 6-5, 7-16, C-3, C-38, C-240, C-268
- MRAS Field Frequency C-119, C-237, C-268
- MRAS Speed Percent C-119, C-237, C-268
- MRAS Speed RPM C-119, C-237, C-268
- MRAS Torque C-119, C-237, C-268
- MRAS Torque XE "MRAS Torque" Percent C-237
- MRAS Torque Percent C-119
- MRAS Torque Percent C-268
- Mutual Inductance C-90, C-116, C-241, C-268
- Nameplate Mag Current 5-3, C-20, C-21, C-256, C-268, C-271, C-272, C-273
- Nameplate Speed 5-3, 6-5, 7-11, C-58, C-116, C-117, C-239, C-268
- Negative Torque Lim C-217, C-238, C-268
- Nominal Supply 6-5, C-57, C-58, C-248, C-268

12 Index

- OEM ID C-61, C-251, C-268
- Open Connections 5-6, A-8, A-9, C-251, C-268
- Option DHCP Enabled 5-6, C-235, C-268
- Option FTP Admin Mode 5-5, C-235, C-268
- Option FTP Enable 5-5, C-235, C-268
- Option Gateway 5-6, C-235, C-268
- Option IO Diagnostic C-100, C-250, C-268
- Option IO Fitted 7-16, C-100, C-250, C-268
- Option IO Required 5-4, 6-4, 7-6, 7-13, C-100, C-250, C-268
- Option IP Address 5-6, C-235, C-268
- Option MAC Address 5-6, C-235, C-268
- Option Subnet Mask 5-6, C-235, C-268
- Option Web Enable 5-5, 6-7, C-235, C-268
- Other Parameters 5-5, C-32, C-231, C-255, C-268
- Output A 5-4, A-17, C-184, C-185, C-252, C-259, C-268
- Output A XE "Output A" Invert C-252
- Output A Invert C-185
- Output A Invert C-268
- Output B 5-4, C-184, C-185, C-252, C-259, C-268
- Output B XE "Output B" Invert C-252
- Output B Invert C-185
- Output B Invert C-268
- Output Enable 5-4, C-183, C-257, C-268
- Output Mapping 5-4, A-13, A-15, A-19, A-31, A-35, A-37, A-54
- Output Source 5-4, C-183, C-184, C-185, C-257, C-268
- Output Voltage 5-4, C-183, C-257, C-268
- Output Z 5-4, C-184, C-185, C-252, C-259, C-268
- Output Z XE "Output Z" Invert C-252
- Output Z Invert C-185
- Output Z Invert C-268
- Parity And Stop Bits 5-5, 6-7, C-236, C-268
- Password in Favourite C-88, C-250, C-268
- Password in Local C-88, C-250, C-268
- Peer to Peer Enable 5-5, 8-28, 8-30, C-258, C-268
- Peer to Peer State 5-6, 8-31, C-258, C-268
- Phase at Rated Current C-261, C-268
- PMAC Back Emf Const KE 5-3, C-130, C-241, C-268
- PMAC Base Volt 5-3, 6-5, C-20, C-132, C-253, C-268
- PMAC Encoder Offset 5-3, 6-5, C-39, C-132, C-144, C-147, C-148, C-149, C-260, C-268
- PMAC Fly Active C-127, C-243, C-268
- PMAC Fly Load Level C-127, C-243, C-268
- PMAC Fly Search Mode C-127, C-243, C-268
- PMAC Fly Search Time C-127, C-243, C-268
- PMAC Fly Setpoint C-128, C-243, C-268
- PMAC Flycatching Enable C-127, C-243, C-268
- PMAC Max Current 5-3, 6-5, C-20, C-43, C-129, C-130, C-241, C-268
- PMAC Max Speed 5-3, 6-5, C-20, C-130, C-138, C-241, C-268
- PMAC Motor Inertia 5-3, 6-5, C-20, C-131, C-241, C-269
- PMAC Motor Poles 5-3, 6-5, C-20, C-130, C-241, C-269
- PMAC Rated Current 5-3, 6-5, C-20, C-43, C-130, C-138, C-241, C-269
- PMAC Rated Torque 5-3, 6-5, C-20, C-130, C-241, C-269
- PMAC SVC Auto Values C-134, C-239, C-269
- PMAC SVC I Gain Hz C-134, C-239, C-269
- PMAC SVC LPF Speed Hz C-134, C-239, C-269
- PMAC SVC Open Loop Strt C-134, C-138, C-239, C-269
- PMAC SVC P Gain C-134, C-239, C-269
- PMAC SVC Start Cur 5-3, 6-5, C-135, C-138, C-239, C-269
- PMAC SVC Start Speed 5-3, 6-6, C-135, C-138, C-239, C-269
- PMAC SVC Start Time C-135, C-138, C-239, C-269
- PMAC Therm Time Const 5-3, 6-5, C-131, C-241, C-269
- PMAC Torque Const KT 5-3, 6-5, C-131, C-241, C-269
- PMAC Winding Inductance 5-3, 6-5, C-131, C-241, C-269
- PMAC Winding Resistance 5-3, 6-5, C-21, C-131, C-241, C-269
- PMAC Wiring 5-3, 5-5, 6-5, C-132, C-142, C-145, C-147, C-148, C-149, C-260, C-269
- Positive Torque Lim C-217, C-238, C-269
- Power Factor 5-3, 5-6, 6-5, C-64, C-117, C-238, C-239, C-269, C-271, C-272, C-273
- Power Factor XE "Power Factor" Angle Est C-238
- Power Factor Angle Est C-64
- Power Factor Angle Est C-269
- Power Factor XE "Power Factor" Est C-238
- Power Factor Est 5-6, C-64
- Power Factor Est C-269
- Power HP 5-6, C-64, C-238, C-269
- Power kW 5-6, C-64, C-238, C-269
- Power Parameters 5-5, C-31, C-32, C-231, C-255, C-269
- Power Stack Fitted 7-12, C-58, C-240, C-269
- Power Stack Required 6-2, 7-6, 7-12, C-31, C-32, C-57, C-58, C-248, C-269
- Process Active 5-6, A-8, A-9, C-248, C-269
- Product Code Flags C-61, C-256, C-269
- Profibus Node Address 5-5, 6-7, C-236, C-269
- Profibus State 5-6, C-236, C-269
- PROFINET Device Name 5-6, C-237, C-269
- PROFINET State 5-6, A-33, A-35, A-51, A-53, C-237, C-264, C-269
- Project Author C-13, C-249, C-269
- Project Description C-14, C-249, C-269
- Project File Name C-13, C-249, C-269
- Project Version C-13, C-249, C-269
- PTP Clock 5-5, 5-6, 8-22, 8-24, 8-27, C-257, C-258, C-269
- PTP Clock XE "PTP Clock" Mode C-257
- PTP Clock Mode 5-5, 8-19, 8-24
- PTP Clock Mode C-269
- PTP Clock XE "PTP Clock" Type C-257
- PTP Clock Type 5-5, 8-19, 8-22, 8-24
- PTP Clock Type C-269
- PTP Domain Number 5-5, 8-22, 8-24, C-259, C-269
- PTP Enable 5-5, 8-19, 8-20, 8-21, 8-24, C-257, C-269
- PTP Lock Threshold 5-5, 8-25, C-257, C-269
- PTP Locked 5-6, 8-21, 8-25, 8-27, C-257, C-269
- PTP Log Sync Interval 5-5, 8-22, 8-25, C-257, C-269
- PTP Offset 5-6, 8-27, C-257, C-269
- PTP Priority2 5-5, 8-23, 8-25, C-257, C-269
- PTP State 5-6, 8-26, C-257, C-269
- Pwrl Accel Rate C-150, C-151, C-152, C-257, C-269
- Pwrl Active C-151, C-257, C-269
- Pwrl Control Band C-150, C-151, C-257, C-269
- Pwrl Decel Rate C-151, C-152, C-257, C-269
- Pwrl Enable C-150, C-151, C-256, C-269
- Pwrl Time Limit 7-5, C-151, C-257, C-269
- Pwrl Trip Threshold C-150, C-151, C-257, C-269
- Quickstop Ramp Time C-164, C-240, C-269
- Quickstop Time Limit C-164, C-240, C-269
- Ramp Hold 2-3, C-162, C-240, C-269
- Ramp Spd Setpoint Input C-162, C-240, C-269

- Ramp Speed Output C-163, C-209, C-240, C-269, E-3
- Ramp Type 6-6, C-160, C-161, C-239, C-269
- Ramping Active C-162, C-240, C-269
- Random Pattern AFE C-257, C-269
- Random Pattern IM C-122, C-238, C-269
- Random Pattern PMAC C-123, C-251, C-269
- Rated Motor Current 5-3, 6-5, C-116, C-239, C-269, C-271, C-272, C-273
- Ratio Load Mot Inert C-204, C-251, C-269
- Reactive Power 5-6, C-64, C-238, C-269
- Read Mapping 5-5, C-233, C-234, C-269
- Read Mapping[x] C-269
- Recent Trip Times C-221, C-254, C-269
- Recent Trip Times[x] C-269
- Recent Trips A-2, C-221, C-247, C-269
- Recent Trips[0] C-221
- Recent Trips[x] C-269
- Red LED Force Off C-105, C-261, C-269
- Ref Trim Local C-209
- Reference 6-8, 2-3, A-5, A-13, A-15, A-19, A-23, A-35, A-37, 2-3, 2-5, 2-6, C-1, C-35, C-36, C-106, C-188, C-190, C-191, C-197, C-242, C-266, C-267, C-268, C-269
- Regen Limit Enable C-43, C-237, C-269
- Reset Energy Meter C-64, C-65, C-238, C-269
- Reset to Defaults 6-2, C-249, C-269
- Resolver Active Resol C-170, C-261, C-269
- Resolver Actual Filter C-169, C-261, C-269
- Resolver Built-In Gear 5-4, 6-4, C-261, C-269
- Resolver Fraction Turns 5-6, C-168, C-170, C-260, C-269
- Resolver Frequency 5-4, 6-4, C-167, C-260, C-269
- Resolver Invert 5-4, 6-4, C-168, C-260, C-269
- Resolver Max Speed 5-4, 6-4, C-167, C-170, C-261, C-269
- Resolver Min Filter 5-4, 6-4, C-169, C-261, C-269
- Resolver Poles 5-4, 6-4, C-168, C-260, C-269
- resolver position 5-6
- Resolver Position C-168, C-261, C-269
- Resolver Ratio 5-4, 6-4, C-167, C-171, C-260, C-269
- Resolver Reset Power On C-170, C-260, C-269
- Resolver Resolution 5-4, 6-4, C-169, C-260, C-269
- Resolver Speed % 5-6, C-169, C-260, C-269
- Resolver Speed Filter 5-4, 6-4, C-168, C-260, C-269
- Resolver Speed Hz C-168, C-169, C-261, C-269
- Resolver Speed Ripple C-169, C-261, C-269
- Resolver Speed RPM C-169, C-260, C-269
- Resolver State C-170, C-260, C-269
- Resolver Trip Type 7-6, C-170, C-171, C-260, C-269
- Resolver Turns 5-6, C-168, C-170, C-171, C-260, C-269
- Resolver Turns XE "Resolver Turns" Reset C-260
- Resolver Turns Reset C-170, C-171
- Resolver Turns Reset C-269
- Resolver Voltage 5-4, 6-4, C-167, C-259, C-269
- Rotor Resistance C-253, C-269
- Rotor Time Constant C-21, C-90, C-237, C-241, C-269
- RTA Code 5-6, C-55, C-249, C-269
- RTA Data 5-6, C-55, C-249, C-269
- RTA Thread Priority C-249, C-269
- RTC Trim C-86, C-250, C-269
- Run Key Action C-106, C-250, C-269
- Run Wizard? 6-1, C-193, C-249, C-269
- Save All Parameters C-53, C-249, C-269
- SB Dig Out 1 Invert C-176, C-253, C-269
- SB Dig Out 2 Invert C-176, C-253, C-269
- SB Dig Out 3 Invert C-176, C-253, C-269
- SB Digital In 1 Invert C-175, C-252, C-269
- SB Digital In 2 Invert C-175, C-252, C-269
- SB Digital In 3 Invert C-175, C-252, C-269
- SB Digital In 4 Invert C-175, C-253, C-269
- SB Digital In 5 Invert C-175, C-253, C-269
- SB Digital In 6 Invert C-175, C-253, C-269
- SB Digital Input 1 5-5, C-174, C-175, C-259, C-269
- SB Digital Input 2 5-5, C-174, C-175, C-258, C-269
- SB Digital Input 3 5-6, C-174, C-175, C-258, C-269
- SB Digital Input 4 C-174, C-175, C-253, C-269
- SB Digital Input 5 C-174, C-175, C-176, C-253, C-269
- SB Digital Input 6 C-174, C-175, C-176, C-253, C-269
- SB Digital Output 1 C-174, C-175, C-176, C-253, C-269
- SB Digital Output 2 C-174, C-176, C-253, C-269
- SB Digital Output 3 C-174, C-176, C-253, C-269
- Scaled PNO Access C-192, C-261, C-269
- Search Boost C-83, C-237, C-269, C-271, C-272, C-273
- Search Mode C-83, C-127, C-237, C-268, C-269
- Search Time C-84, C-127, C-237, C-268, C-269, C-271, C-272, C-273
- Search Volts C-83, C-237, C-269, C-271, C-272, C-273
- Sel Torq Ctrl Only C-203, C-206, C-240, C-269
- Selected Parameter C-105, C-261, C-269
- Seq Stop Method SVC 5-3, 6-6, C-160, C-251, C-269
- Seq Stop Method VHz 5-3, 6-6, C-160, C-239, C-269
- Sequencing State 7-15, 2-1, C-18, C-190, C-242, C-269
- Setup 4-3, 4-6, 4-9, 4-10, 5-1, 5-2, 5-3, 6-1, 6-2, 6-3, 6-4, 6-5, 6-8, 6-17, 6-21, 8-3, 8-11, 8-17, 8-24, 8-25, 8-30, 8-31, A-9, A-10, A-30, A-31, A-52, A-54, C-1, C-2, C-3, C-8, C-9, C-15, C-16, C-20, C-21, C-22, C-23, C-24, C-25, C-29, C-30, C-34, C-35, C-38, C-39, C-42, C-43, C-44, C-53, C-56, C-57, C-58, C-62, C-66, C-67, C-69, C-78, C-85, C-87, C-90, C-94, C-95, C-96, C-98, C-100, C-109, C-110, C-111, C-112, C-116, C-124, C-125, C-129, C-130, C-132, C-138, C-142, C-143, C-153, C-154, C-156, C-157, C-158, C-160, C-167, C-177, C-178, C-180, C-182, C-183, C-184, C-186, C-192, C-193, C-194, C-200, C-201, C-215, C-216, C-217, C-229, C-232, C-233, C-234, C-235, C-236, C-237, C-238, C-239, C-240, C-241, C-242, C-246, C-247, C-248, C-249, C-250, C-251, C-252, C-253, C-254, C-255, C-256, C-257, C-258, C-259, C-260, C-261, C-262, C-263, C-265, C-266, C-267, C-268, C-269
- Setup XE "Setup" Successful C-259
- Setup Successful C-35
- Setup Successful C-269
- Setup[x] C-269
- Short Overload Level C-211, C-212, C-238, C-269
- Short Overload Time C-211, C-212, C-238, C-269
- Show Warnings 1 - 32 C-226, C-234, C-269
- Show Warnings 33 - 64 C-226, C-234, C-269
- Slave Encoder C-36, C-259, C-269
- Slave Position Src C-35, C-259, C-269
- Slew Rate Accel Limit C-197, C-238, C-269
- Slew Rate Decel Limit C-197, C-238, C-269
- Slew Rate Enable C-197, C-238, C-269
- Slip Compensatn Enable C-198, C-238, C-269
- SLP Motoring Limit C-198, C-238, C-269
- SLP Regen Limit C-198, C-238, C-269
- SNTP Client Enable 8-19, C-259, C-269
- SNTP Remote Server 8-19, C-259, C-269
- SNTP Server Enable 8-20, C-262, C-269
- SNTP Status 8-19, C-253, C-269
- Soft Key 2 Mode C-89, C-260, C-269

14 Index

- Soft Key 2 Value C-89, C-260, C-269
- Spd Demand Neg Lim C-206, C-207, C-240, C-269
- Spd Demand Pos Lim C-206, C-207, C-240, C-269
- Spd Limiter Torq Ctrl C-203, C-207, C-259, C-269
- Spd Loop Adapt Pgain C-206, C-240, C-269
- Spd Loop Adapt Thres C-206, C-240, C-269
- Spd Loop Aux Torq Dmd C-206, C-240, C-269
- Spd Loop Dmd Filt TC C-205, C-240, C-269
- Spd Loop Encoder C-37, C-259, C-269
- Spd Loop Fbk Filt TC C-205, C-240, C-269
- Speed Demand Hz C-186, C-239, C-270
- Speed Demand RPM C-186, C-239, C-270
- Speed Error Threshold C-208, C-259, C-270
- Speed Error Trip Delay C-208, C-259, C-270
- Speed Error Trip Enable C-208, C-259, C-270
- Speed Limiter Active C-203, C-259, C-270
- Speed Loop Auto Set C-204, C-251, C-270
- Speed Loop Bandwidth C-204, C-251, C-270
- Speed Loop Error C-203, C-240, C-270
- Speed Loop I Time C-204, C-205, C-240, C-270
- Speed Loop Int Defeat C-205, C-240, C-270
- Speed Loop Int Preset C-205, C-240, C-270
- Speed Loop Pgain C-204, C-205, C-240, C-270
- Speed PI Output C-203, C-240, C-270
- Speed Trim C-209, C-251, C-270, E-15
- Stramp Acceleration C-161, C-240, C-270
- Stramp Continuous C-161, C-240, C-270
- Stramp Deceleration C-161, C-240, C-270
- Stramp Jerk 1 C-162, C-240, C-270
- Stramp Jerk 2 C-162, C-240, C-270
- Stramp Jerk 3 C-162, C-240, C-270
- Stramp Jerk 4 C-161, C-162, C-240, C-270
- Stabilisation Enable C-210, C-238, C-270
- Stack Current (%) C-71, C-238, C-270
- Stack Frequency 7-9, C-8, C-21, C-122, C-123, C-238, C-270, C-271, C-272, C-273
- Stack Pcode C-59, C-250, C-270
- Stack Serial No C-59, C-251, C-270
- Stall Current Active C-214, C-247, C-270
- Stall Limit Type C-214, C-247, C-270
- Stall Speed Feedback C-214, C-247, C-270
- Stall Time 7-3, C-214, C-247, C-270, C-271, C-272, C-273
- Stall Torque Active C-214, C-247, C-270
- Start Align Done C-39, C-262, C-270
- Start Delay C-118, C-256, C-270, E-5
- Start Delay XE "Start Delay" Enable C-256
- Start Delay Enable C-118
- Start Delay Enable C-270
- Startup Alignment C-39, C-40, C-262, C-270
- Startup Page 5-5, C-87, C-248, C-270
- Stator Resistance C-21, C-22, C-90, C-91, C-116, C-237, C-241, C-253, C-270
- Status Word 7-15, A-5, A-13, A-15, A-19, A-23, A-35, A-37, 2-1, 2-6, C-18, C-190, C-242, C-270, E-34, E-35
- Stop Ramp Time 5-3, C-160, C-163, C-240, C-270
- Subnet Mask 5-6, 8-3, 8-4, 8-10, 8-11, 8-12, A-12, A-34, C-247, C-267, C-268, C-270
- Switch On Timeout C-190, C-242, C-270
- Switchover Enable C-119, C-120, C-258, C-270, E-38
- Symmetric Mode C-161, C-239, C-270
- Symmetric Time C-161, C-239, C-270, C-271, C-272, C-273
- Symmetric Torque Lim C-217, C-238, C-270
- Synth Encoder Count C-261, C-270
- Synth Encoder Invert 5-4, C-184, C-258, C-270
- Synth Encoder Lines 5-4, C-183, C-258, C-270
- Synth Encoder Speed 5-4, C-183, C-258, C-270
- System Board FE State C-55, C-259, C-270
- System Board Fitted 7-16, C-215, C-259, C-270
- System Board Required 5-4, 7-13, C-215, C-258, C-270
- System Board Status C-215, C-259, C-270
- Target State C-54, C-248, C-270
- Technician Password C-88, C-250, C-270
- Terminal Voltage Mode C-4, C-228, C-238, C-270
- Terminal Volts C-71, C-220, C-255, C-267, C-268, C-270
- Thermistor Resistance C-216, C-250, C-270
- Thermistor Trip Level C-216, C-249, C-270, E-24, E-29
- Thermistor Type 5-4, 6-4, C-216, C-250, C-270
- Thermistor Warn Delta C-216, C-259, C-270, E-24, E-29
- Time and Date 6-2, 8-19, 8-20, C-49, C-166, C-221, C-250, C-270
- Time Since Power-On C-172, C-173, C-258, C-270
- Time Zone Offset 8-19, C-166, C-251, C-270
- Total Spd Demand % C-203, C-240, C-270
- Total Spd Demand RPM C-203, C-240, C-270
- Tr Adaptation Output C-220, C-255, C-270
- Trim in Local C-209, C-251, C-270
- Update Firmware 4-10, 6-2, C-53, C-249, C-270
- Update GKP Text C-261, C-270
- User Gateway Address 5-4, 6-8, 8-4, 8-11, 8-12, A-12, A-34, C-248, C-270
- User IP Address 5-4, 6-8, 8-4, 8-11, 8-12, A-12, A-34, C-247, C-270
- User Subnet Mask 5-4, 6-8, 8-4, 8-11, 8-12, A-12, A-34, C-248, C-270
- VC Flying Start Enable C-83, C-237, C-270
- VDC Lim Active C-51, C-256, C-270
- VDC Lim Enable C-51, C-256, C-270
- VDC Lim Level C-51, C-52, C-256, C-270
- VDC Lim Output C-51, C-256, C-270
- VDC Ripple Filter TC C-227, C-247, C-270
- VDC Ripple Level C-227, C-247, C-270
- VDC Ripple Sample C-227, C-247, C-270
- VDC Ripple Trip Delay C-227, C-247, C-270, C-271, C-272, C-273
- VDC Ripple Trip Hyst C-227, C-247, C-270
- Version 8-14, C-13, C-57, C-60, C-88, C-250, C-266, C-267, C-268, C-269, C-270
- VHz Flying Start Enable C-83, C-237, C-270
- VHz Shape 5-3, 6-6, C-78, C-239, C-270
- VHz User Freq C-80, C-239, C-270
- VHz User Freq[x] C-270
- VHz User Volts C-80, C-239, C-270
- VHz User Volts[x] C-270
- View Level 6-2, 8-15, 8-17, C-87, C-88, C-250, C-270
- Vsd Demand C-80, C-239, C-270
- Vsq Demand C-80, C-239, C-270
- Warnings 1 - 32 5-6, C-225, C-246, C-247, C-270
- Warnings 33 - 64 5-6, C-226, C-240, C-269, C-270
- Warranty Trip Time C-221, C-248, C-270
- Warranty Trip Time[x] C-270
- Warranty Trips C-221, C-248, C-253, C-254, C-270
- Warranty Trips XE "Warranty Trips" Record C-253, C-254
- Warranty Trips Record C-221
- Warranty Trips Record C-270
- Warranty Trips[0] C-221
- Warranty Trips[x] C-270

Web Access 5-4, 5-5, 6-2, 8-15, 8-17, A-14, A-36, C-248,
C-270
Web Parameters Enable 5-5, C-235, C-270
Web Password 8-16, 8-17, C-248, C-270
Web View Level 8-15, 8-17, C-248, C-270

Write Mapping 5-5, C-234, C-235, C-270
Write Mapping[x] C-270
Z Pulse C-184, C-261, C-270
Z Pulse XE "Z Pulse" Init Done C-261
Z Pulse Init Done C-184

Z Pulse Init Done C-270
Zero Speed Stop Delay C-163, C-240, C-270
Zero Speed Threshold C-148, C-149, C-163, C-240, C-
270

Parker Worldwide

Europe, Middle East, Africa

AE – United Arab Emirates, Dubai

Tel: +971 4 8127100
parker.me@parker.com

AT – Austria, Wiener Neustadt

Tel: +43 (0)2622 23501-0
parker.austria@parker.com

AT – Eastern Europe, Wiener Neustadt

Tel: +43 (0)2622 23501 900
parker.easteurope@parker.com

AZ – Azerbaijan, Baku

Tel: +994 50 2233 458
parker.azerbaijan@parker.com

BE/LU – Belgium, Nivelles

Tel: +32 (0)67 280 900
parker.belgium@parker.com

BG – Bulgaria, Sofia
Tel: +359 2 980 1344
parker.bulgaria@parker.com

BY – Belarus, Minsk

Tel: +48 (0)22 573 24 00
parker.poland@parker.com

CH – Switzerland, Etoy

Tel: +41 (0)21 821 87 00
parker.switzerland@parker.com

CZ – Czech Republic, Klecany

Tel: +420 284 083 111
parker.czechrepublic@parker.com

DE – Germany, Kaarst

Tel: +49 (0)2131 4016 0
parker.germany@parker.com

DK – Denmark, Ballerup

Tel: +45 43 56 04 00
parker.denmark@parker.com

ES – Spain, Madrid

Tel: +34 902 330 001
parker.spain@parker.com

FI – Finland, Vantaa

Tel: +358 (0)20 753 2500
parker.finland@parker.com

FR – France, Contamine s/Arve

Tel: +33 (0)4 50 25 80 25
parker.france@parker.com

GR – Greece, Athens

Tel: +30 210 933 6450
parker.greece@parker.com

HU – Hungary, Budaörs

Tel: +36 23 885 470
parker.hungary@parker.com

IE – Ireland, Dublin

Tel: +353 (0)1 466 6370
parker.ireland@parker.com

IL – Israel

Tel: +39 02 45 19 21
parker.israel@parker.com

IT – Italy, Corsico (MI)

Tel: +39 02 45 19 21
parker.italy@parker.com

KZ – Kazakhstan, Almaty

Tel: +7 7273 561 000
parker.easteurope@parker.com

NL – The Netherlands, Oldenzaal

Tel: +31 (0)541 585 000
parker.nl@parker.com

NO – Norway, Asker

Tel: +47 66 75 34 00
parker.norway@parker.com

PL – Poland, Warsaw

Tel: +48 (0)22 573 24 00
parker.poland@parker.com

PT – Portugal

Tel: +351 22 999 7360
parker.portugal@parker.com

RO – Romania, Bucharest

Tel: +40 21 252 1382
parker.romania@parker.com

RU – Russia, Moscow

Tel: +7 495 645-2156
parker.russia@parker.com

SE – Sweden, Spånga

Tel: +46 (0)8 59 79 50 00
parker.sweden@parker.com

SK – Slovakia, Banská Bystrica

Tel: +421 484 162 252
parker.slovakia@parker.com

SL – Slovenia, Novo Mesto

Tel: +386 7 337 6650
parker.slovenia@parker.com

TR – Turkey, Istanbul

Tel: +90 216 4997081
parker.turkey@parker.com

UA – Ukraine, Kiev

Tel: +48 (0)22 573 24 00
parker.poland@parker.com

UK – United Kingdom, Warwick

Tel: +44 (0)1926 317 878
parker.uk@parker.com

ZA – South Africa, Kempton Park

Tel: +27 (0)11 961 0700
parker.southafrica@parker.com

North America

CA – Canada, Milton, Ontario

Tel: +1 905 693 3000

US – USA, Cleveland

Tel: +1 216 896 3000

Asia Pacific

AU – Australia, Castle Hill

Tel: +61 (0)2-9634 7777

CN – China, Shanghai

Tel: +86 21 2899 5000

HK – Hong Kong

Tel: +852 2428 8008

IN – India, Mumbai

Tel: +91 22 6513 7081-85

JP – Japan, Tokyo

Tel: +81 (0)3 6408 3901

KR – South Korea, Seoul

Tel: +82 2 559 0400

MY – Malaysia, Shah Alam

Tel: +60 3 7849 0800

NZ – New Zealand, Mt Wellington

Tel: +64 9 574 1744

SG – Singapore

Tel: +65 6887 6300

TH – Thailand, Bangkok

Tel: +662 186 7000

TW – Taiwan, Taipei

Tel: +886 2 2298 8987

South America

AR – Argentina, Buenos Aires

Tel: +54 3327 44 4129

BR – Brazil, Sao Jose dos Campos

Tel: +55 800 727 5374

CL – Chile, Santiago

Tel: +56 2 623 1216

MX – Mexico, Toluca

Tel: +52 72 2275 4200

European Product Information Centre

Free phone: 00 800 27 27 5374

(from AT, BE, CH, CZ, DE, DK, EE, ES, FI, FR, IE, IL, IS, IT, LU, MT, NL, NO, PL, PT, RU, SE, SK, UK, ZA)



Parker Hannifin Manufacturing Limited Automation Group, Electromechanical & Drives Division Europe,

New Courtwick Lane,
Littlehampton, West Sussex. BN17 7RZ
Office: +44 (0)1903 737000
Fax: +44 (0)1903 737100
www.parker.com/eme